



**3**  2x  2x  3x





- 5** 1x 1x 1x
- 

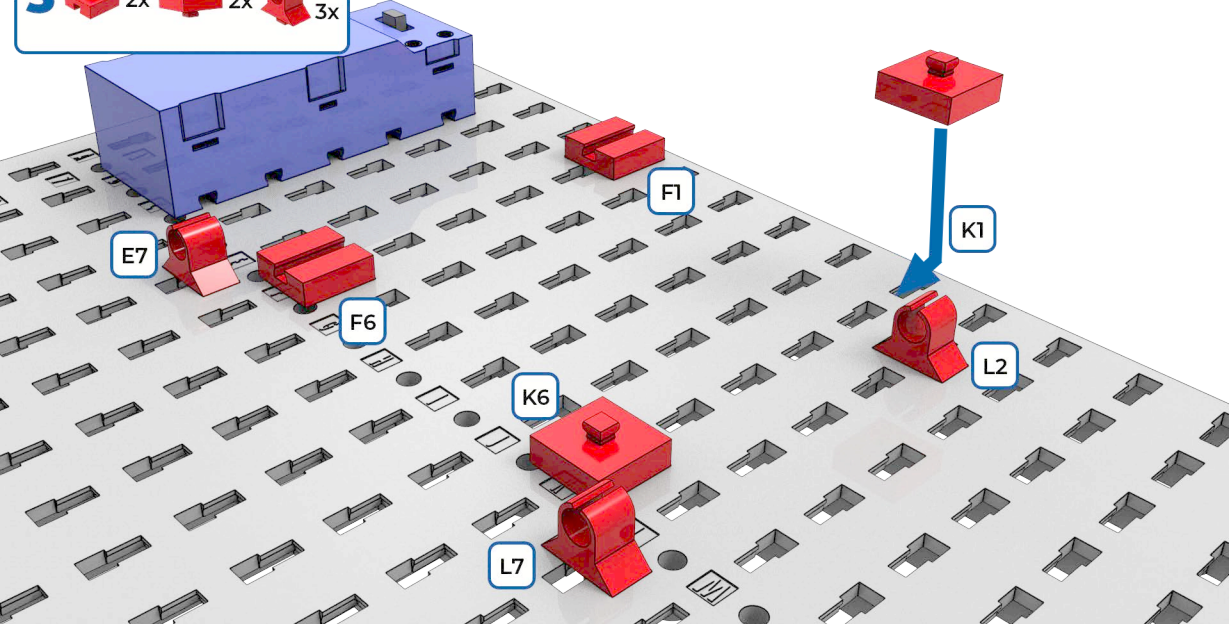
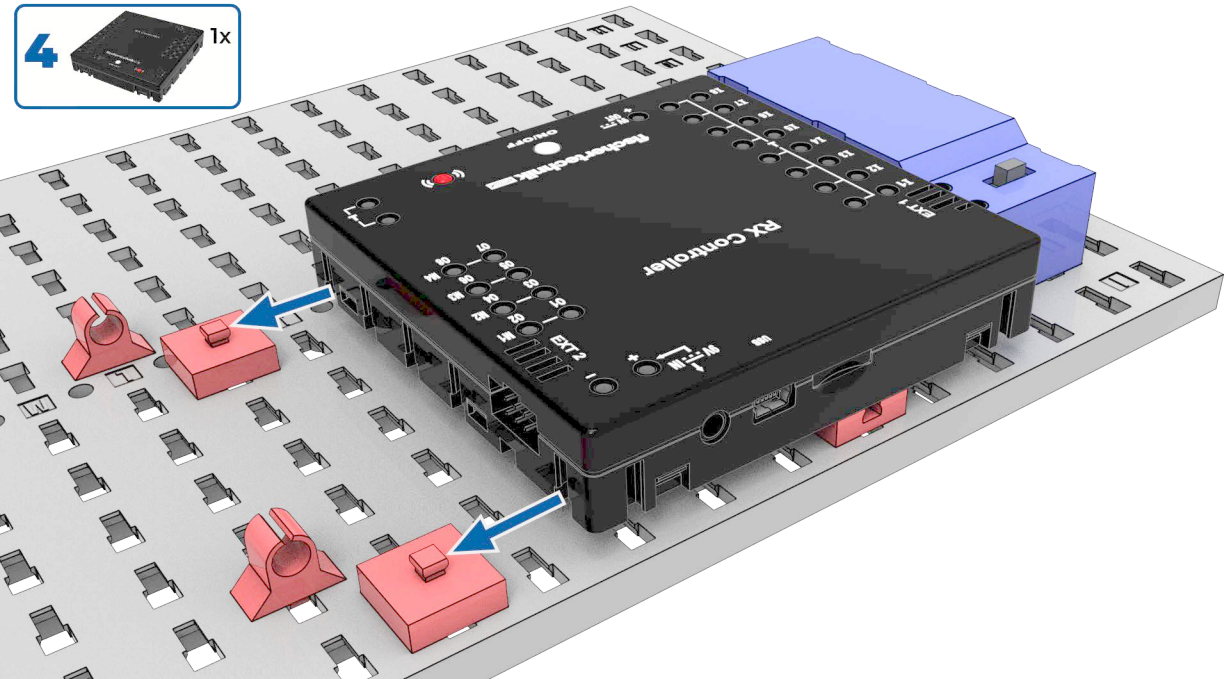
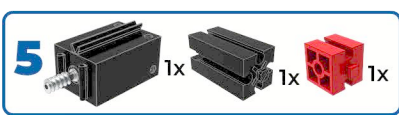
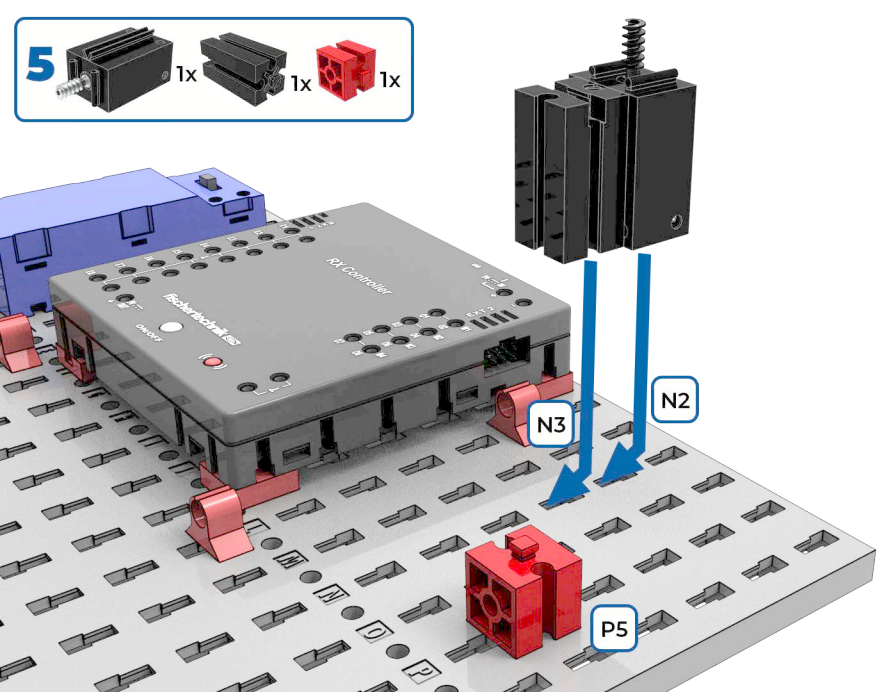

6



1x



20 cm

M1

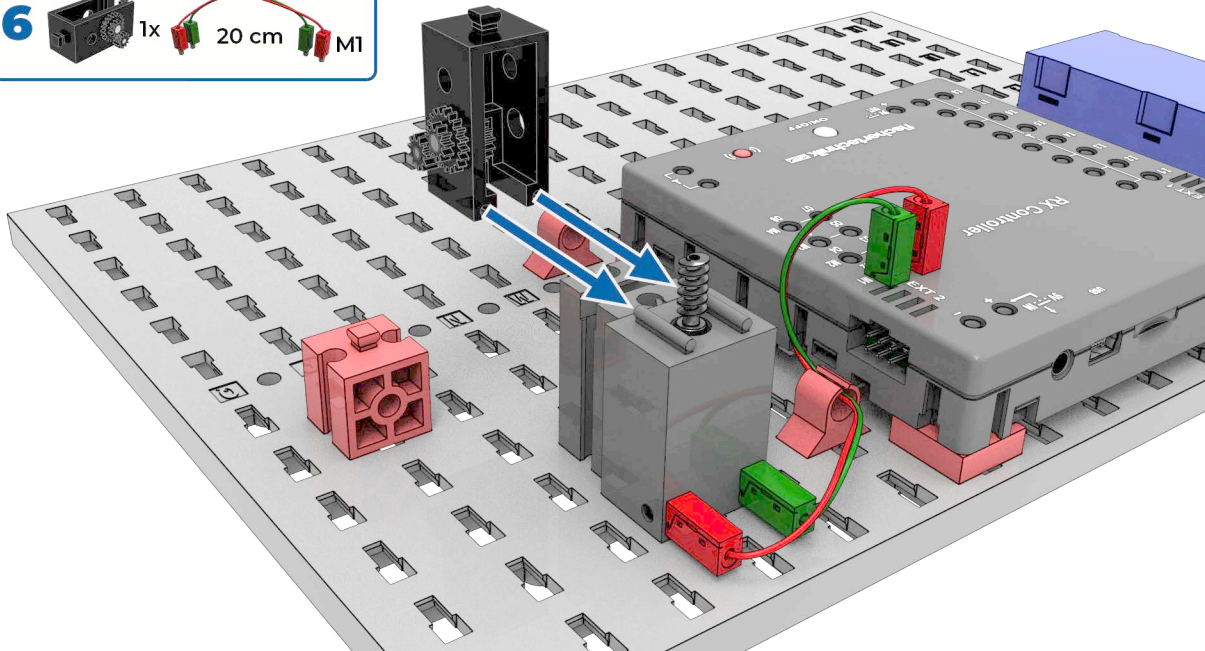

7



1x



1x



1x



1x

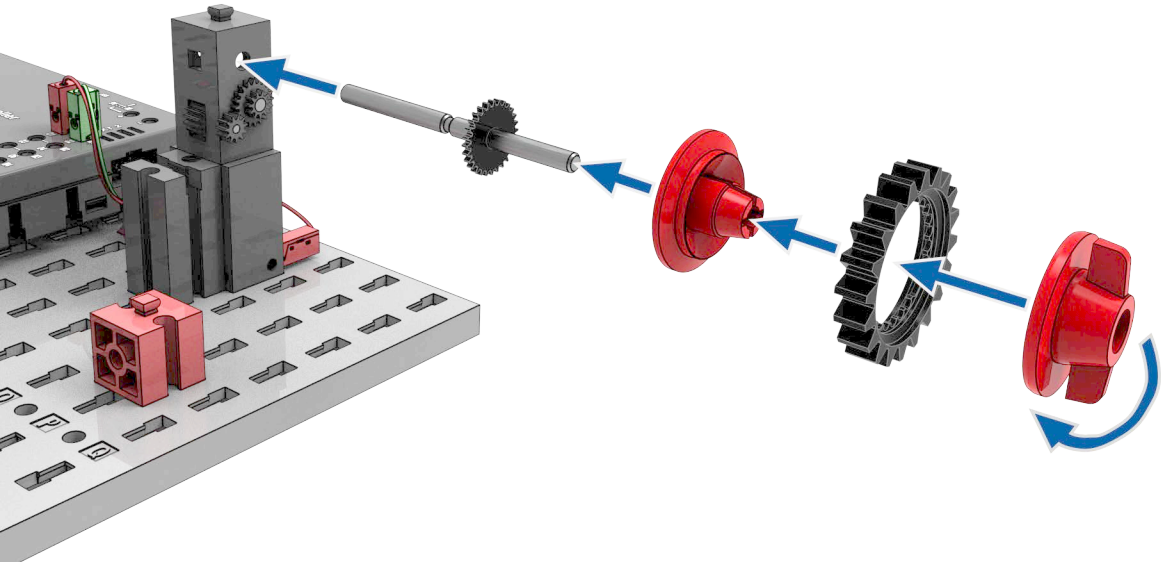



8 1x 1x 1x 30° 1x 1x

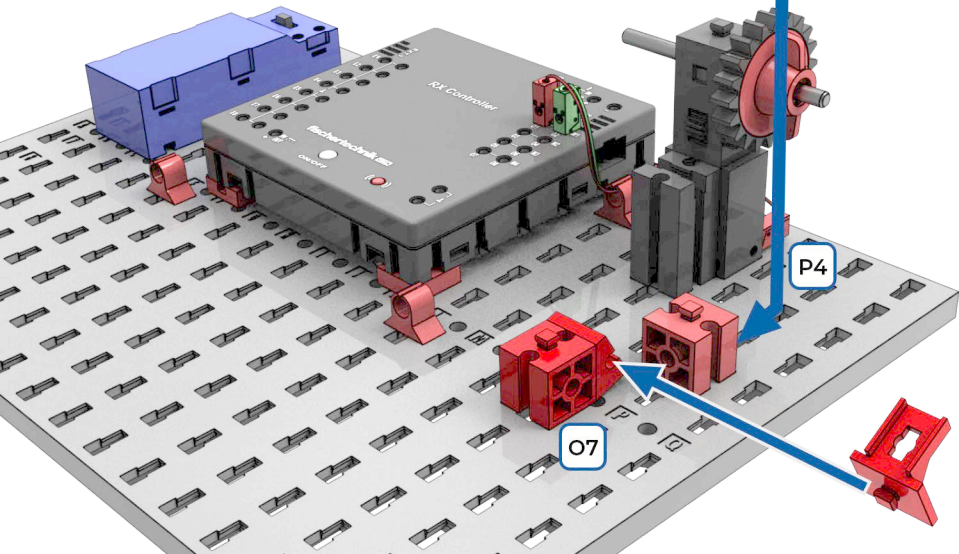

P4

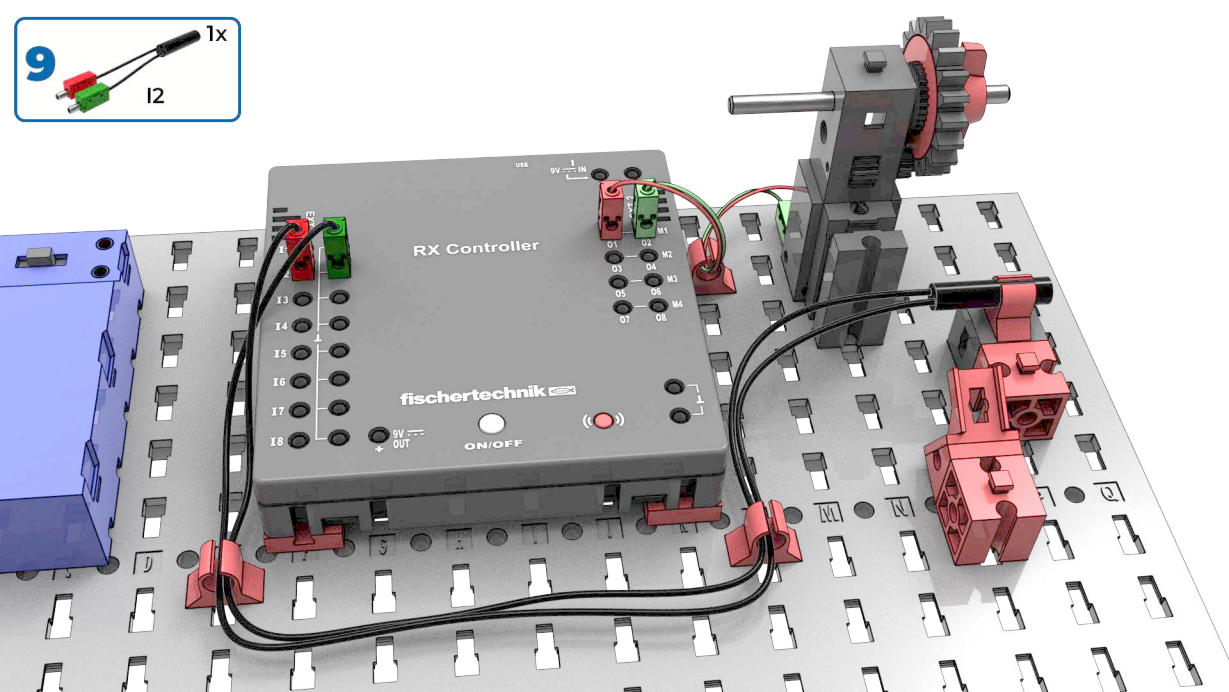
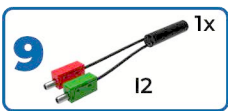

O7

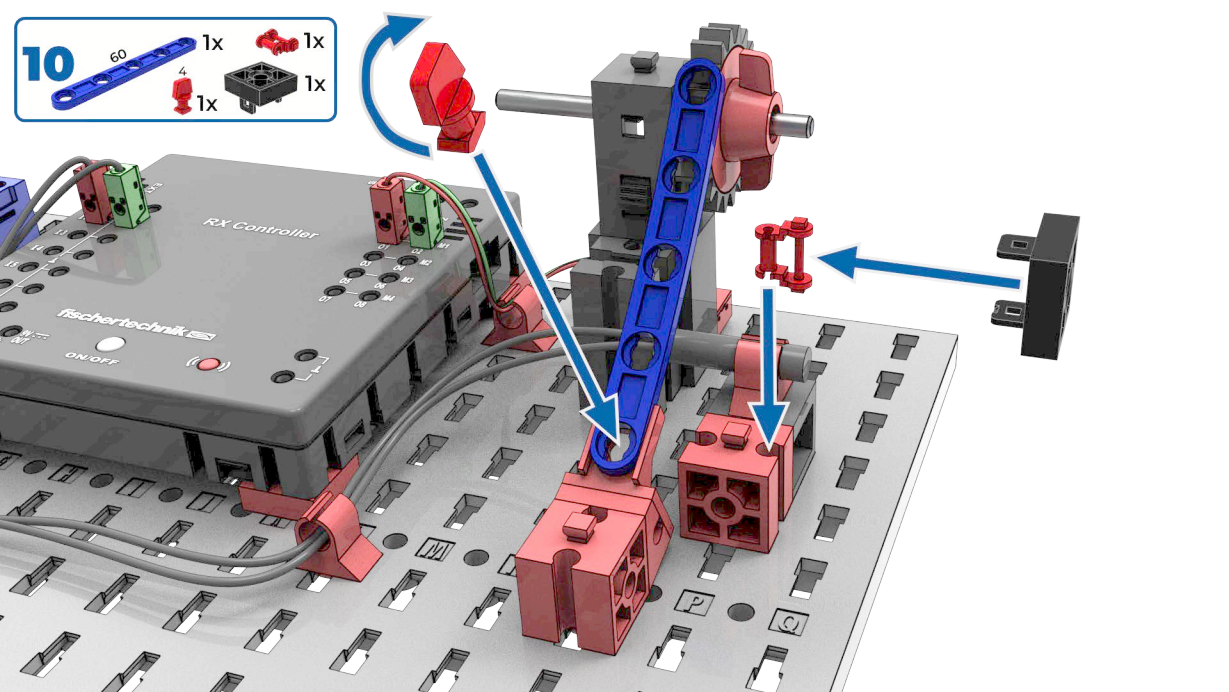

**10**

- 60 1x
- 4 1x
- 1x
- 1x



**11**  1x  1x  1x

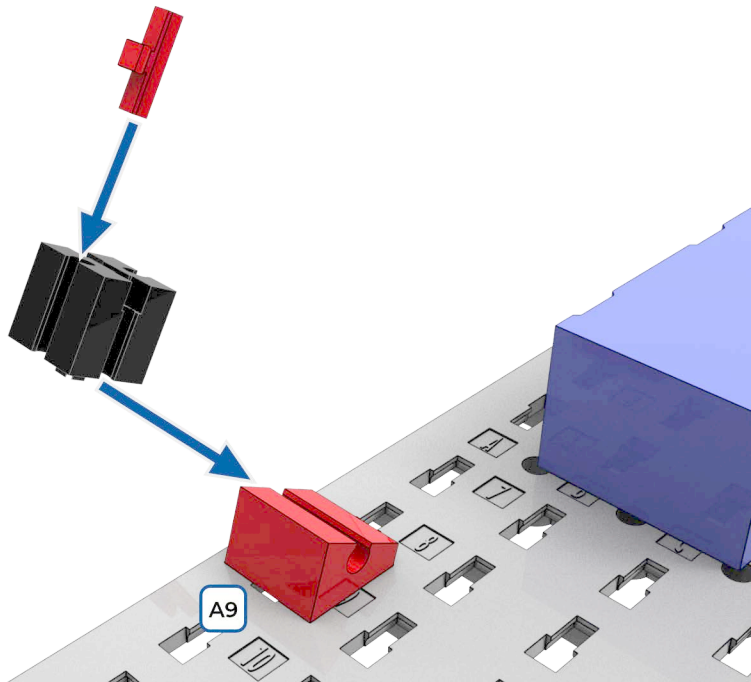

12

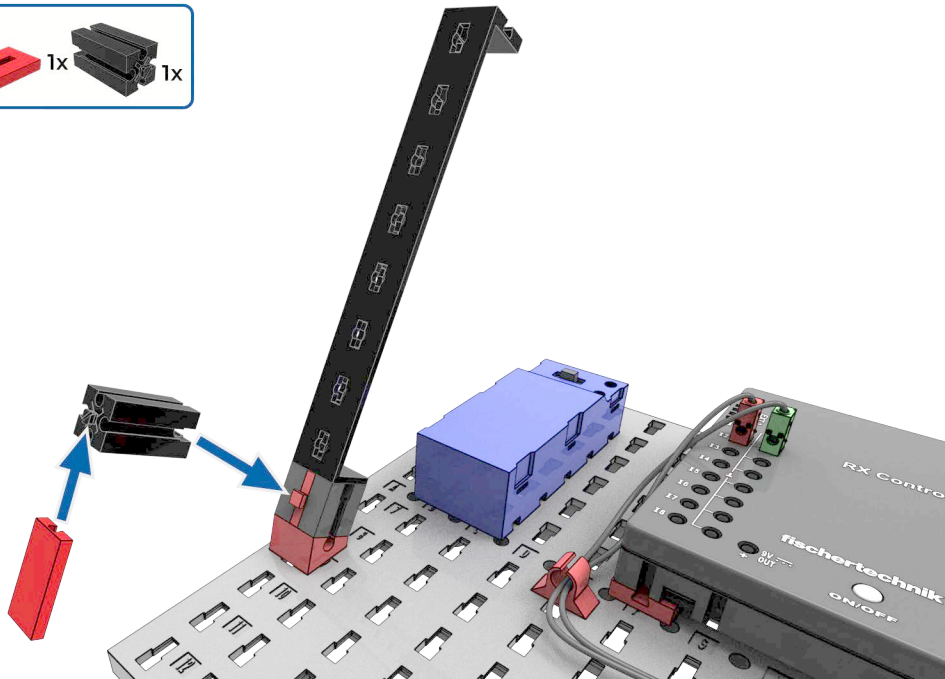
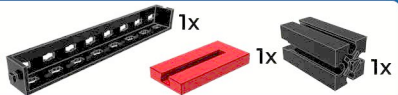

13

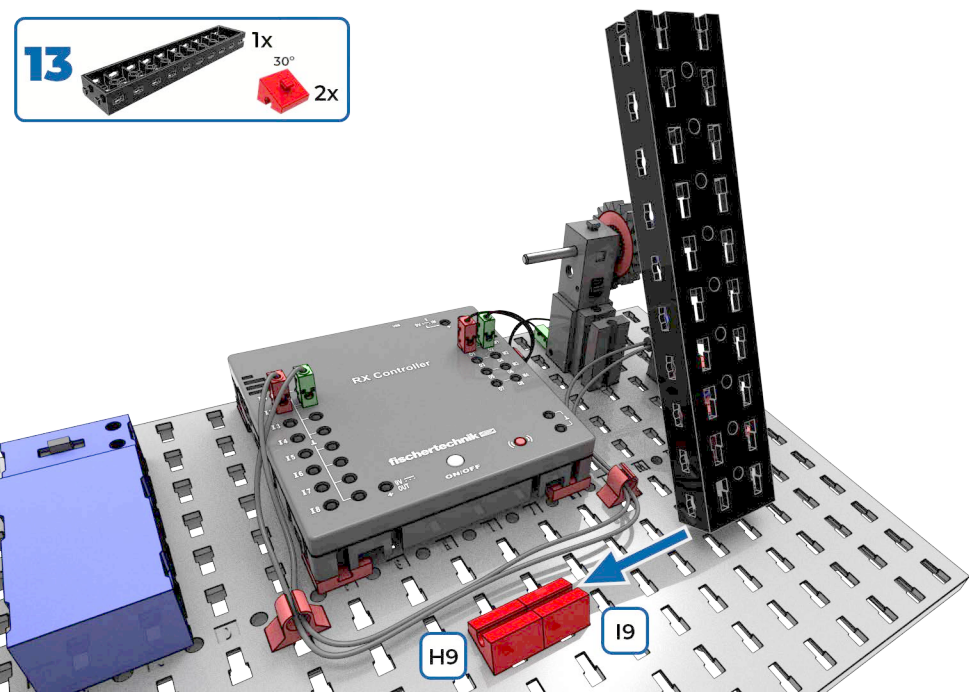

14



1x



2x

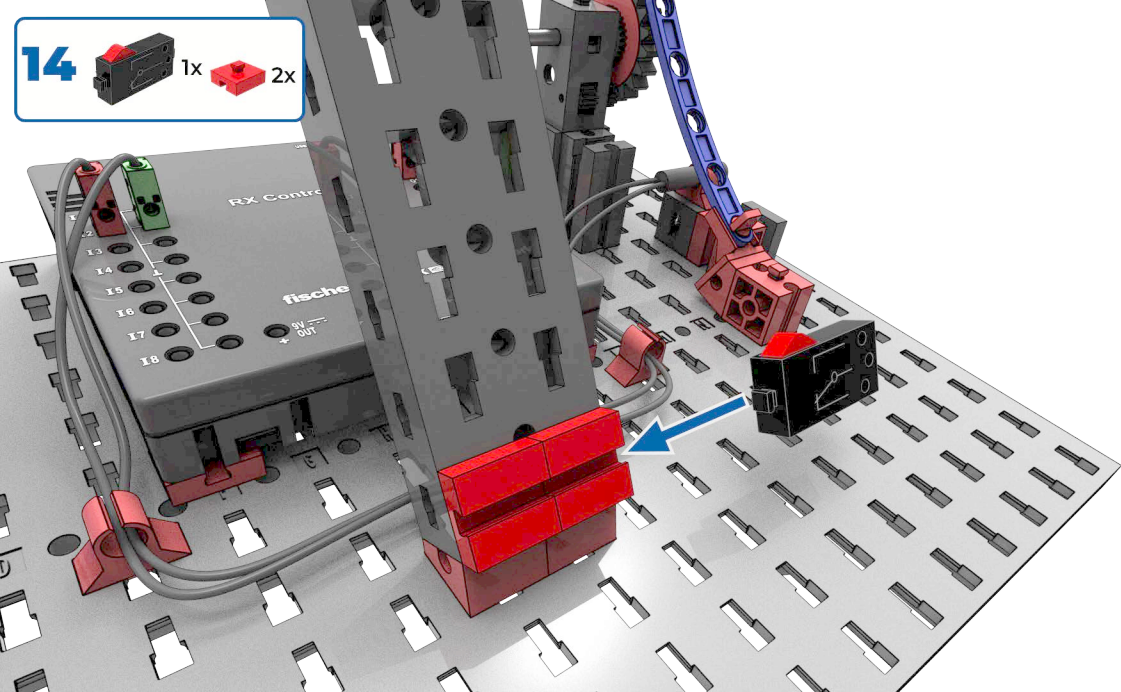



15



30 cm

11

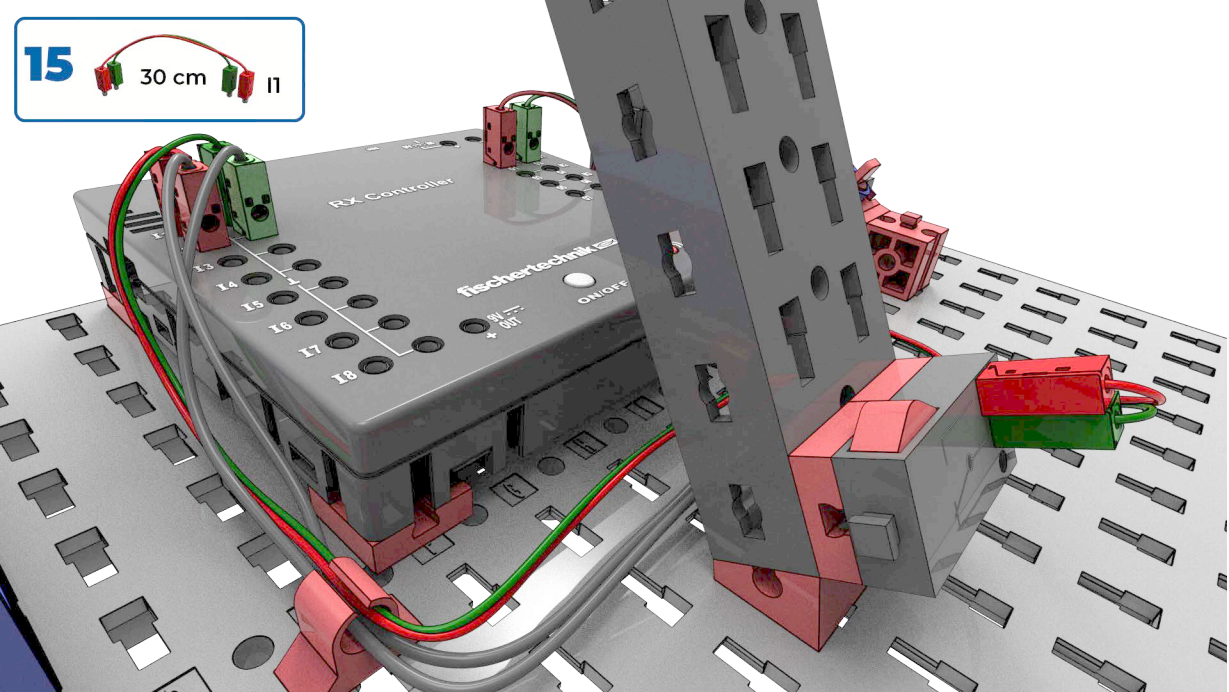



16



1x



1x



1x



1x

30°

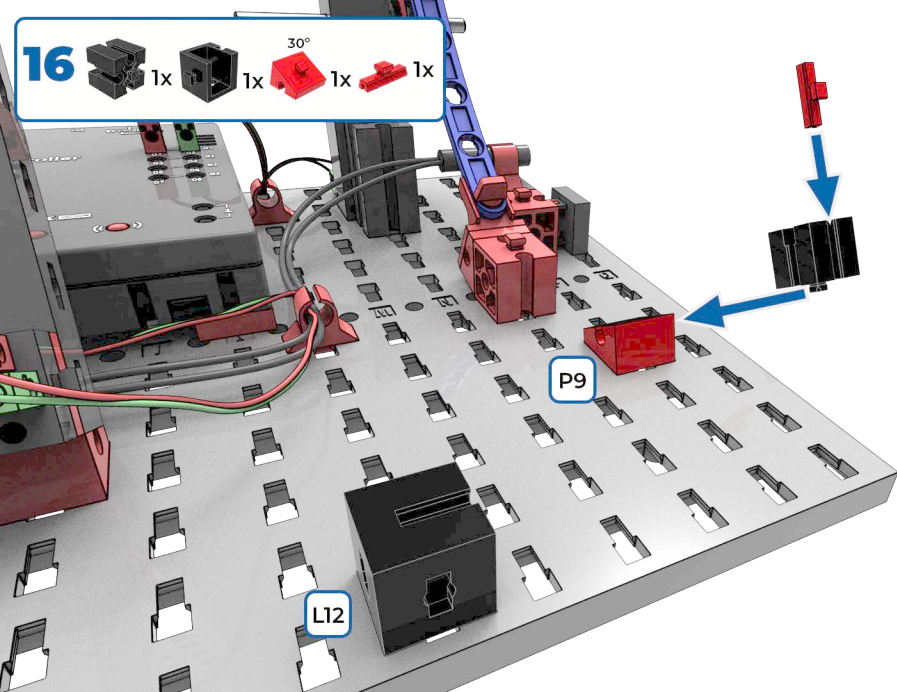

P9

L12

17

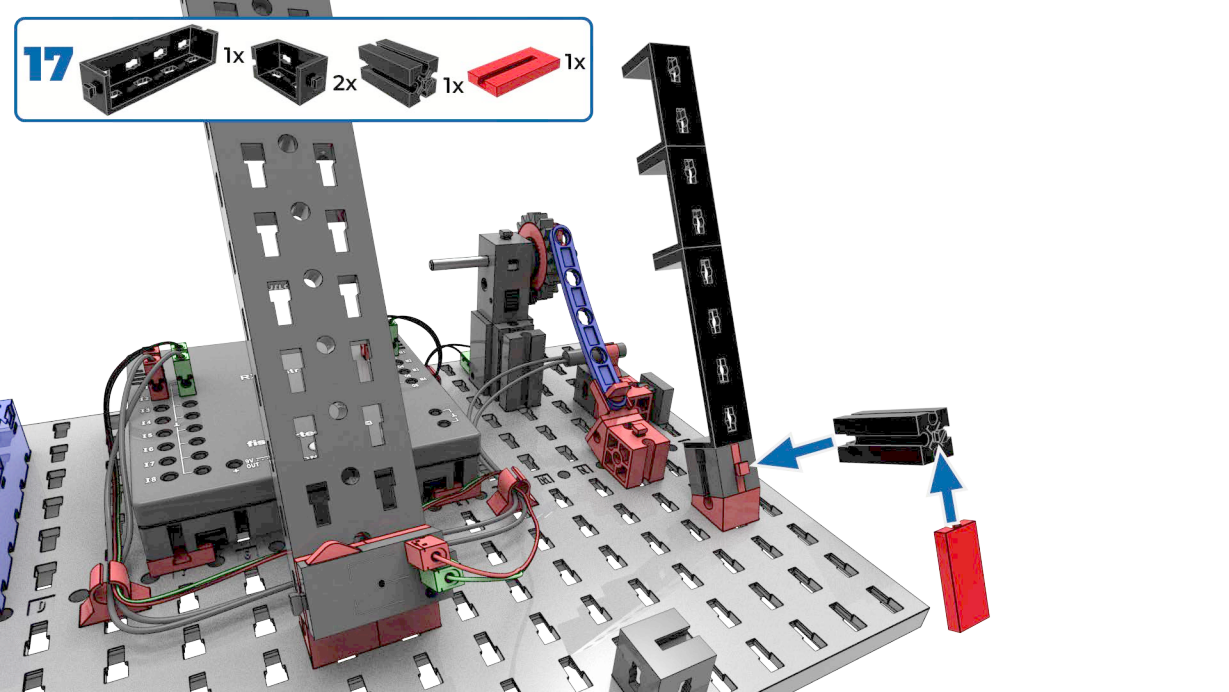
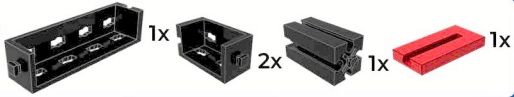

18

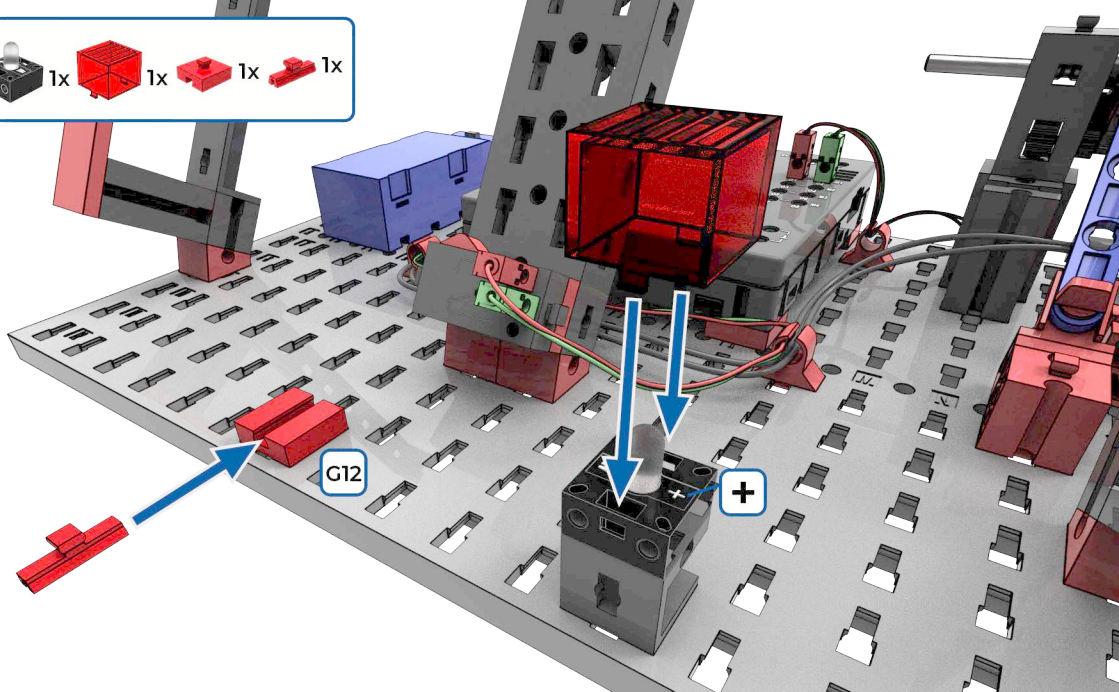
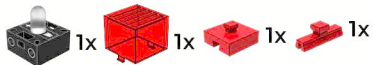

19

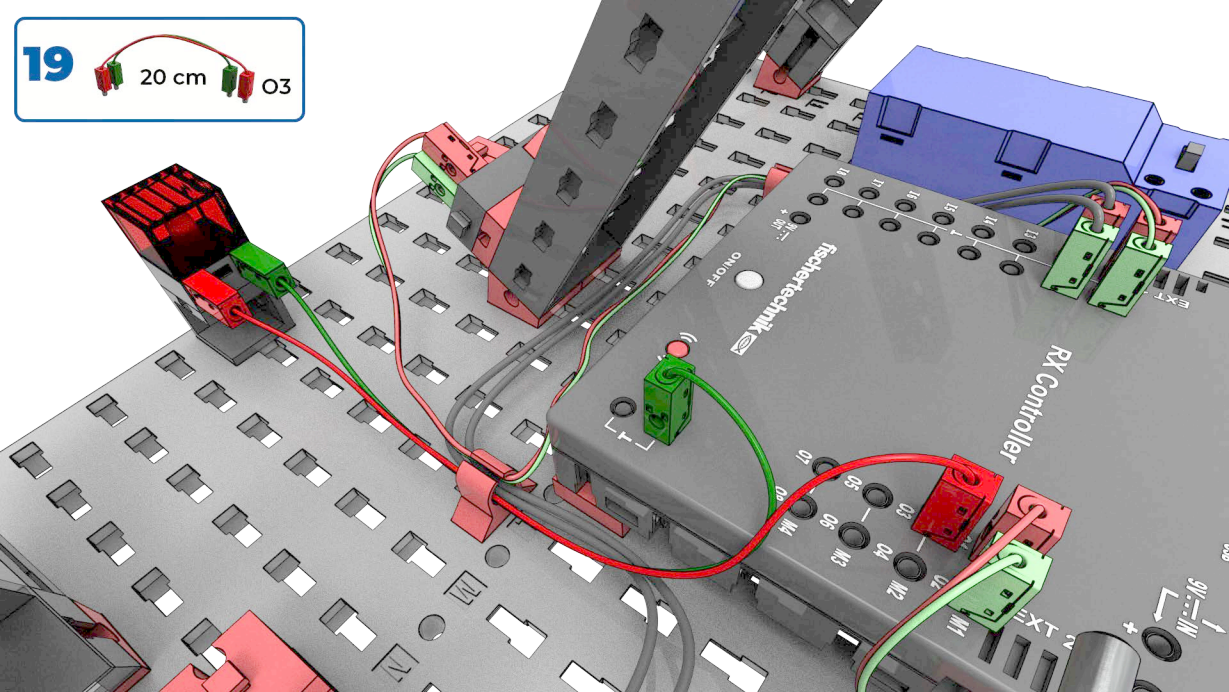
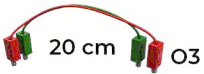

20



1x

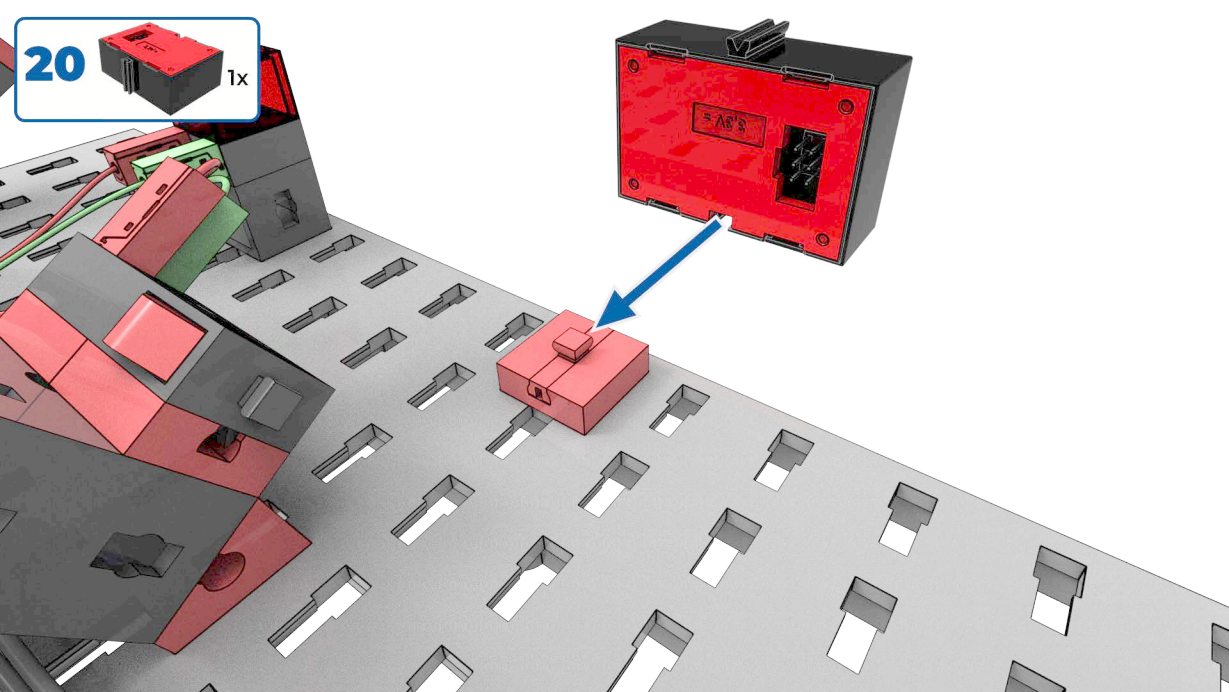
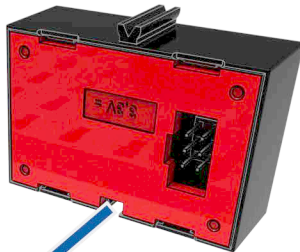



21

1x

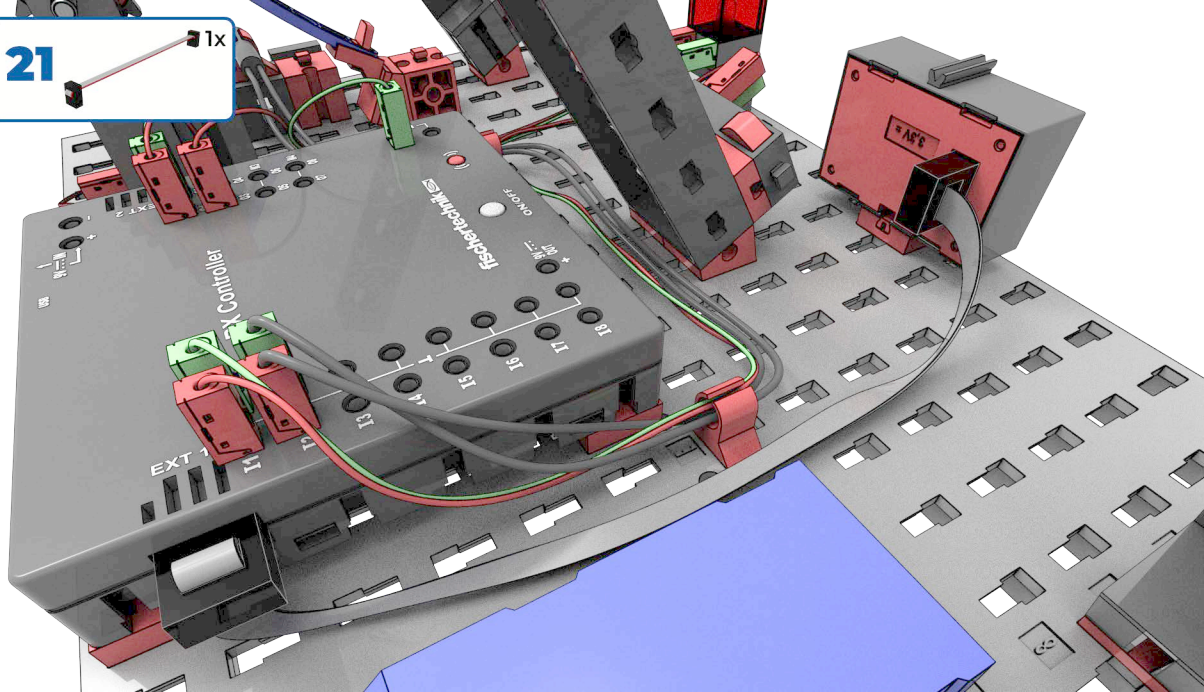

22

40 cm 9V / IN

