

BAUANLEITUNG

STEM Simple Machines

SEKUNDARSTUFE

TEILE

355

MODELLE

14

EXPERIMENTE

70





Schraubstock.....4



Warenautomat.....25



Aufzug.....50



Kniegelenk.....66



Scheibenwischer gegenläufig.....85



Scheibenwischer parallel.....113



Scheibenwischer gleichläufig...141



Federwaage.....158



Flaschenzug.....164



Schiefe Ebene.....198

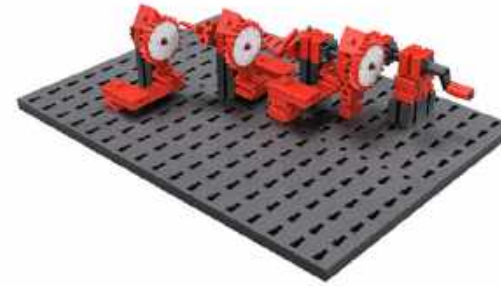

Zählwerk.....236



Exzenterpresse.....257



Kniehebelpresse.....272

Schraubstock



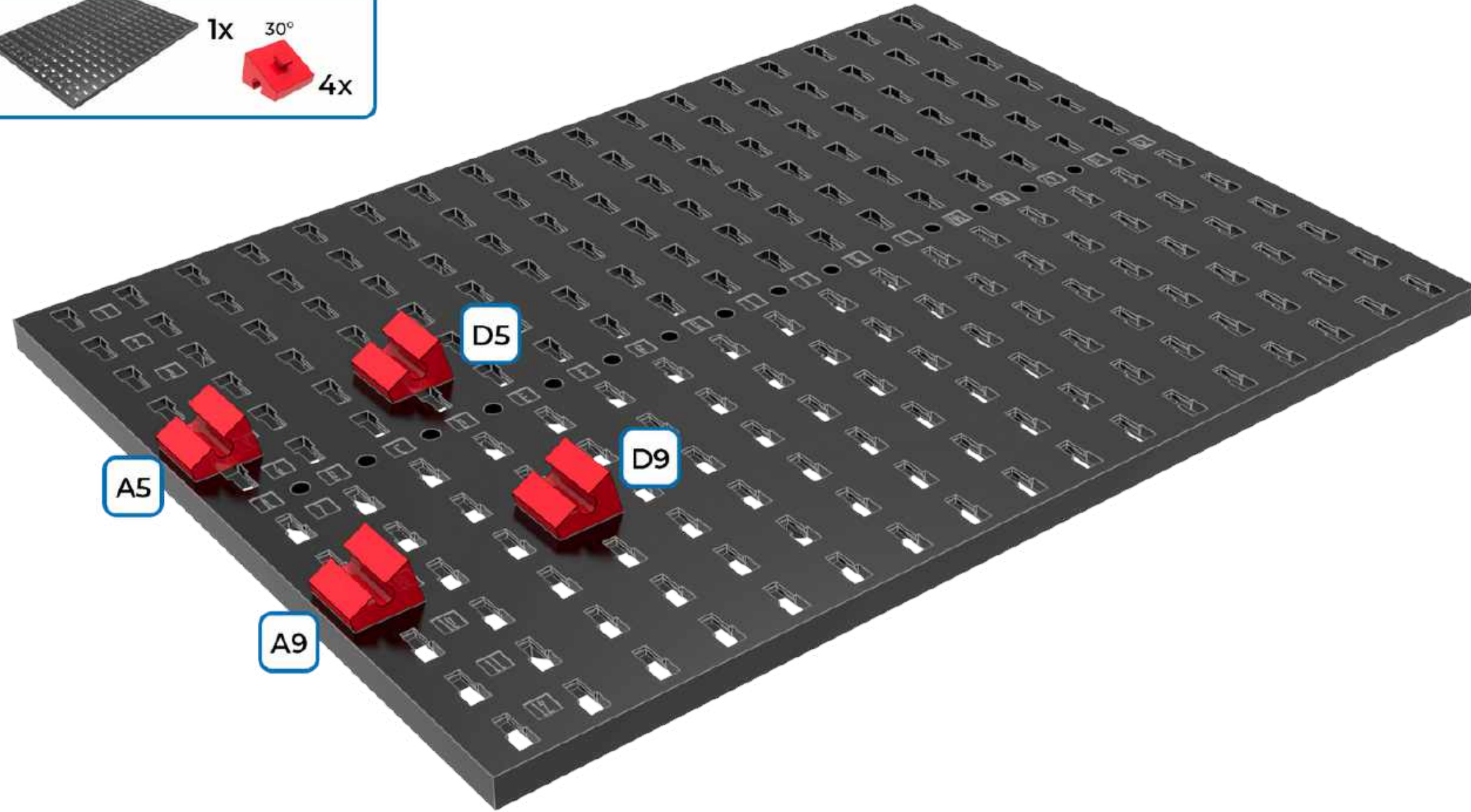
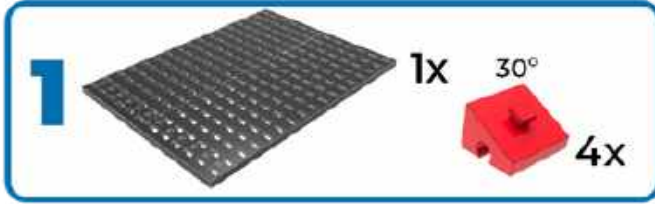

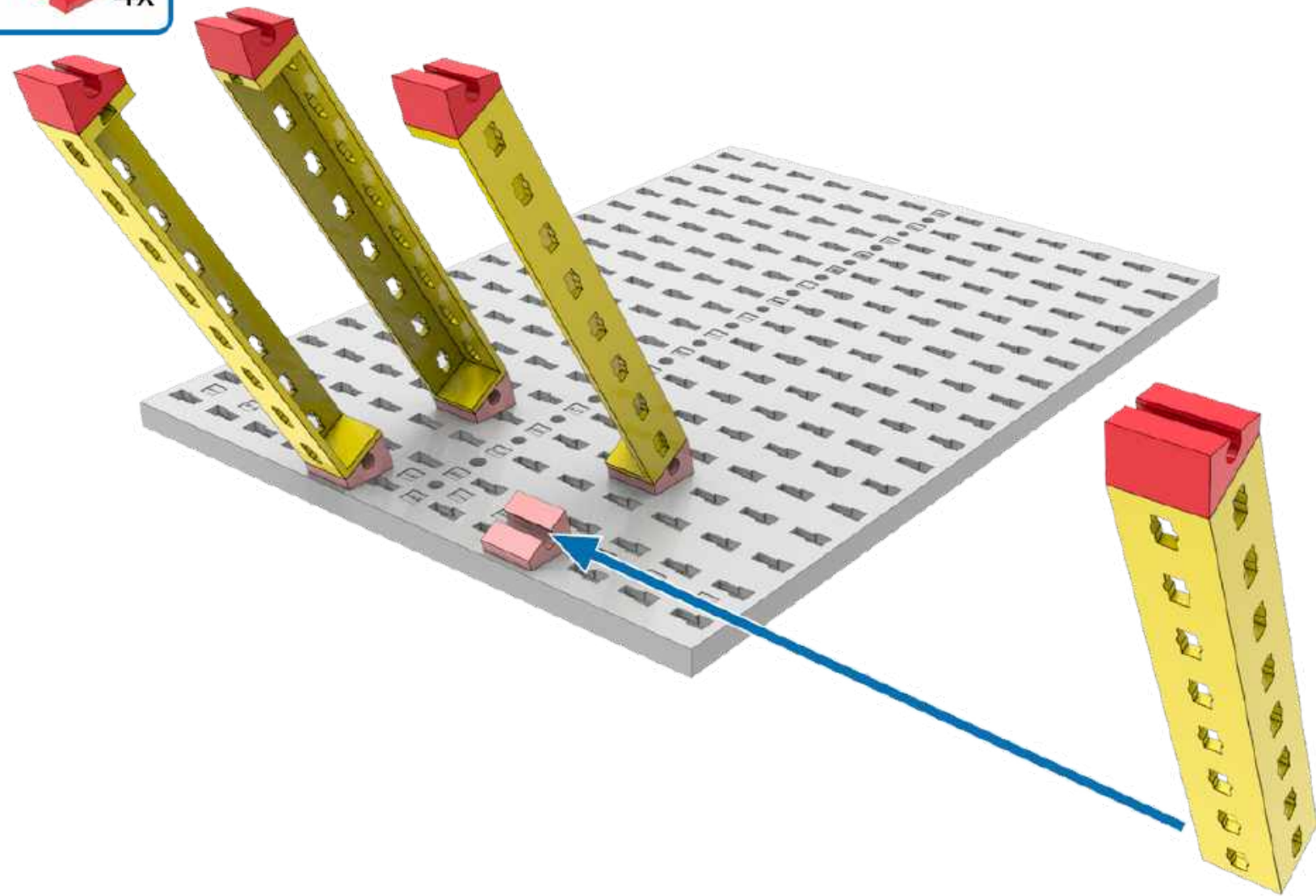
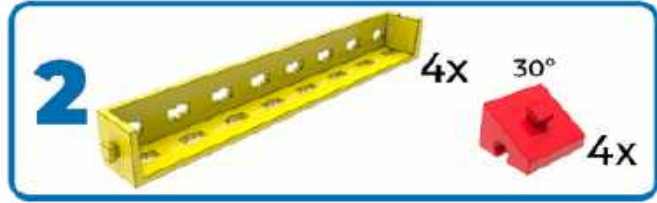

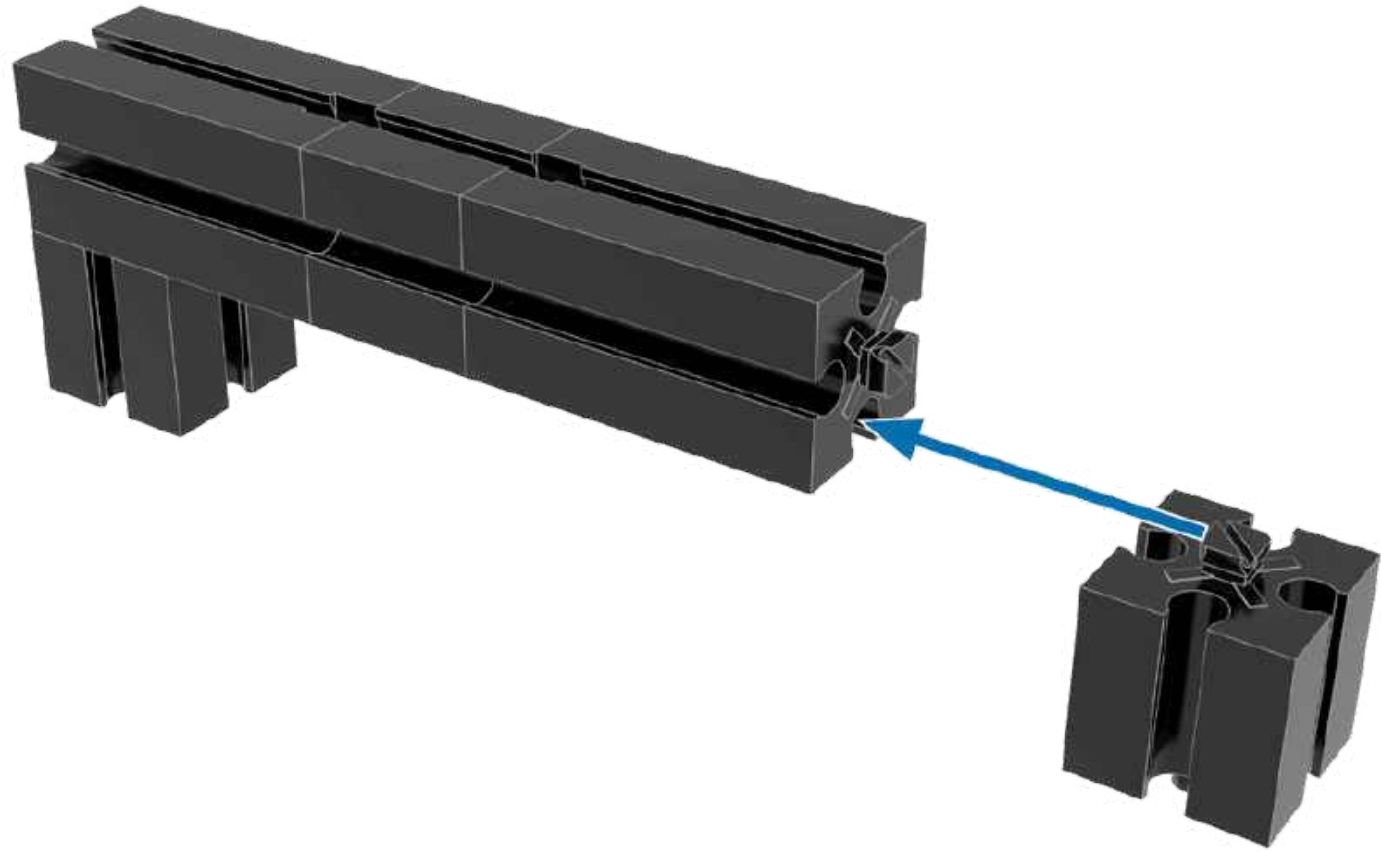
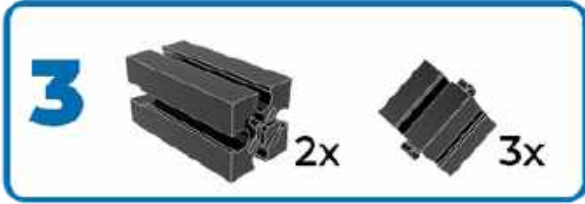

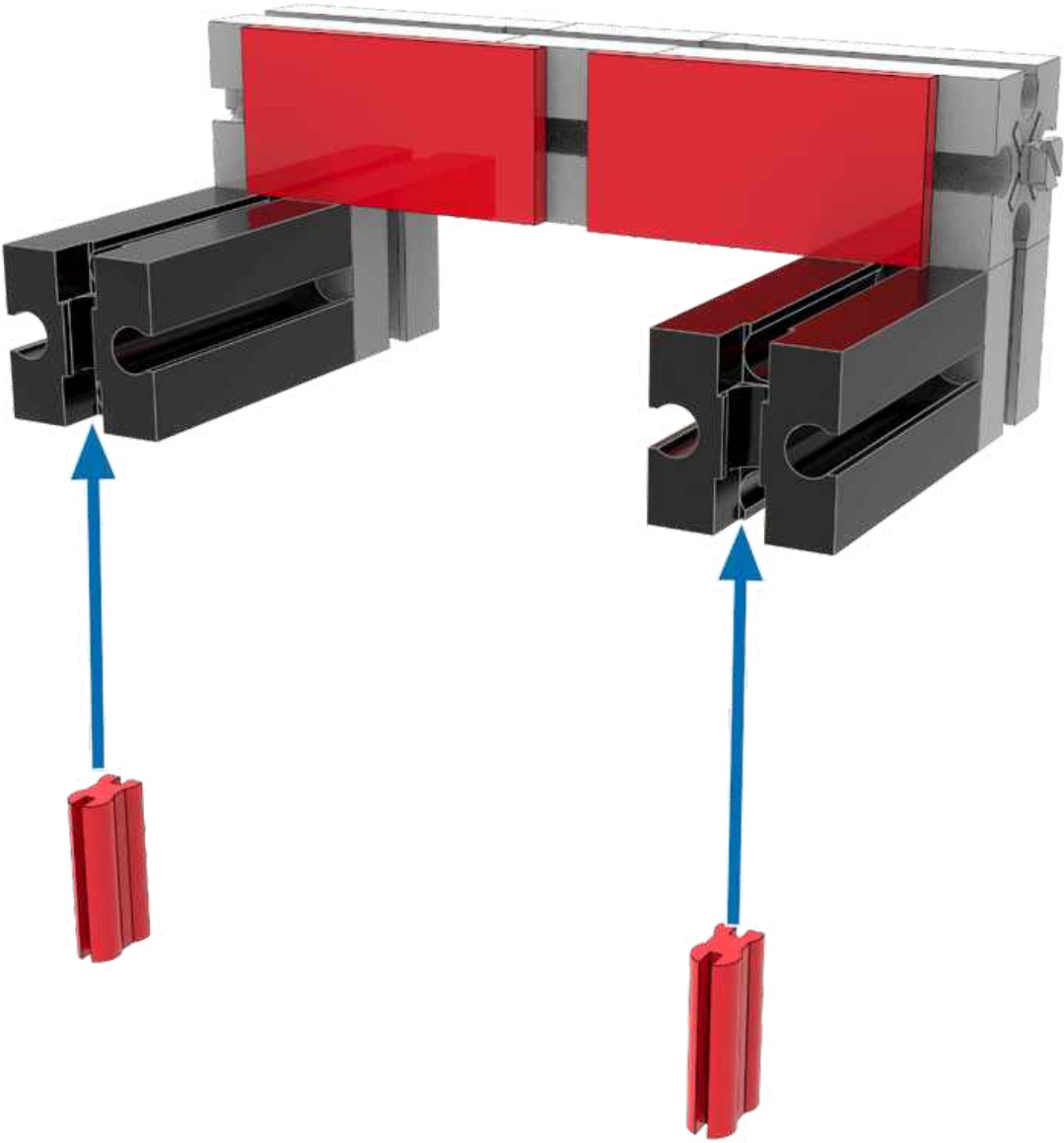
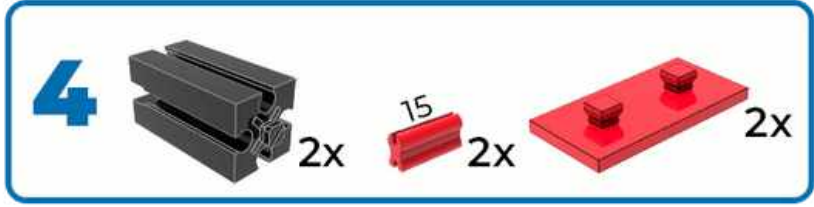

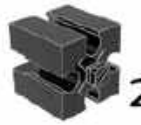

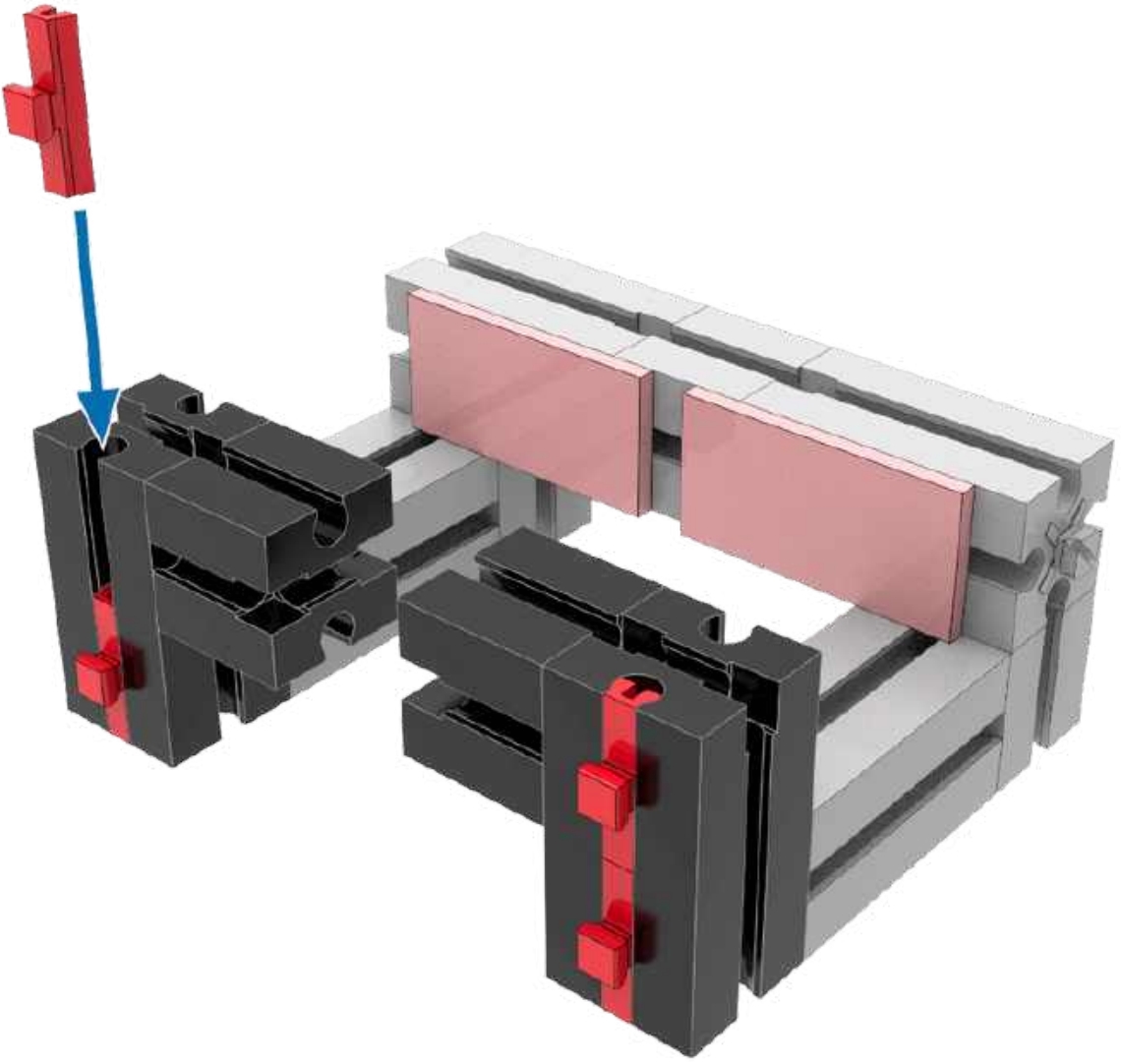

5  2x  2x  4x

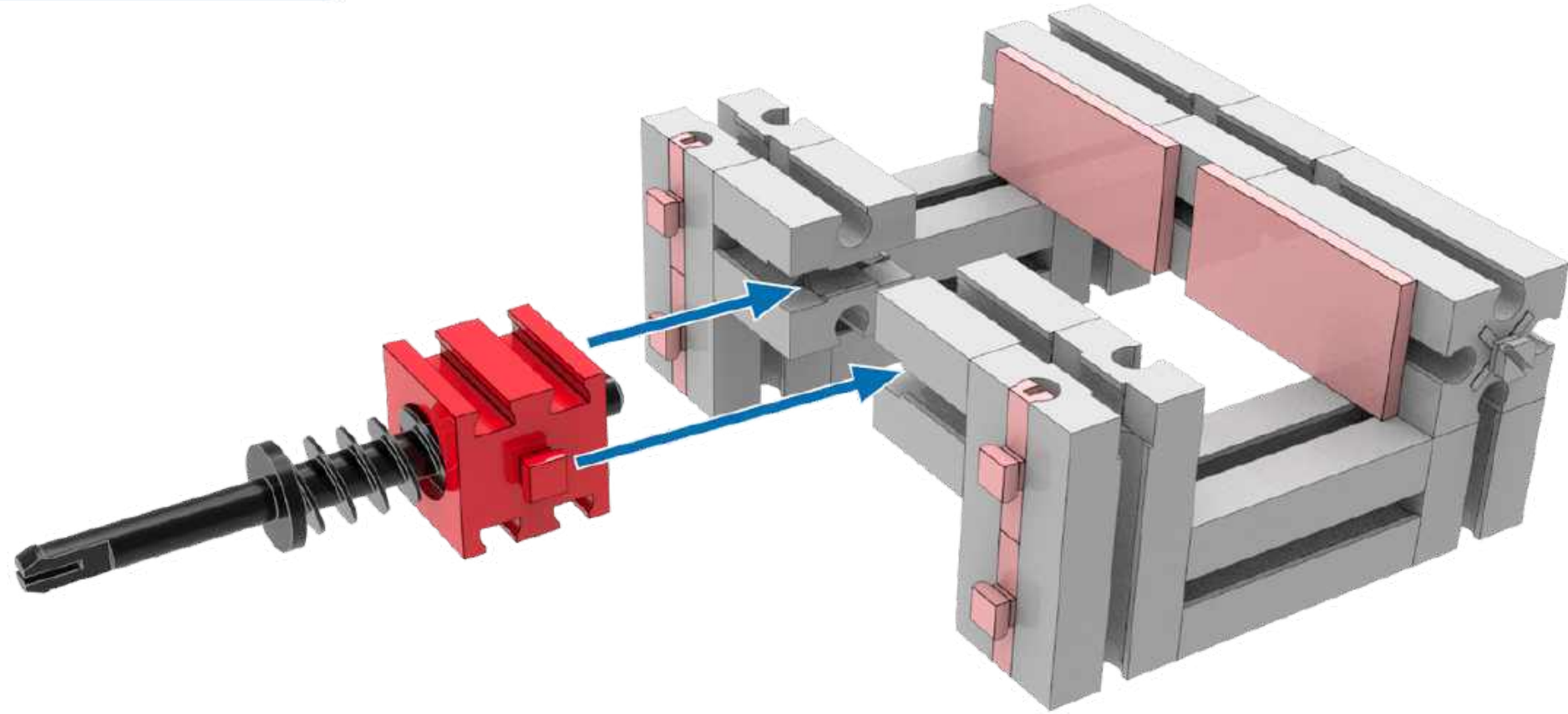
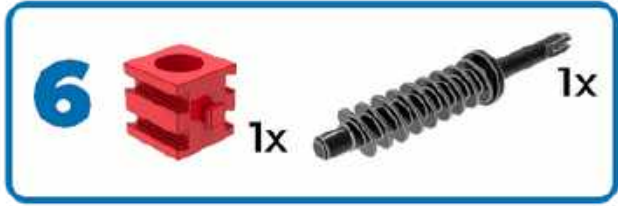



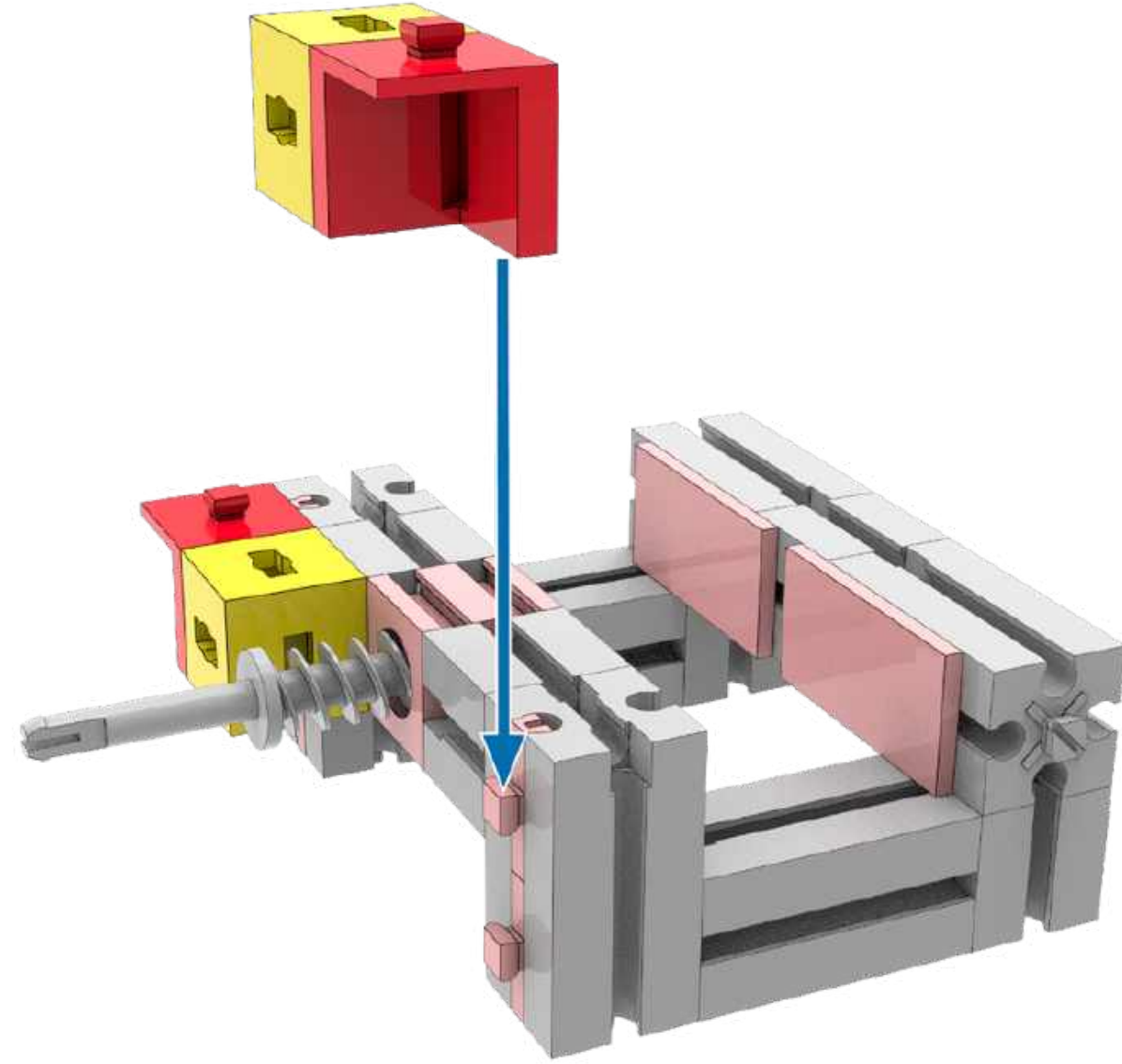

7  2x  2x

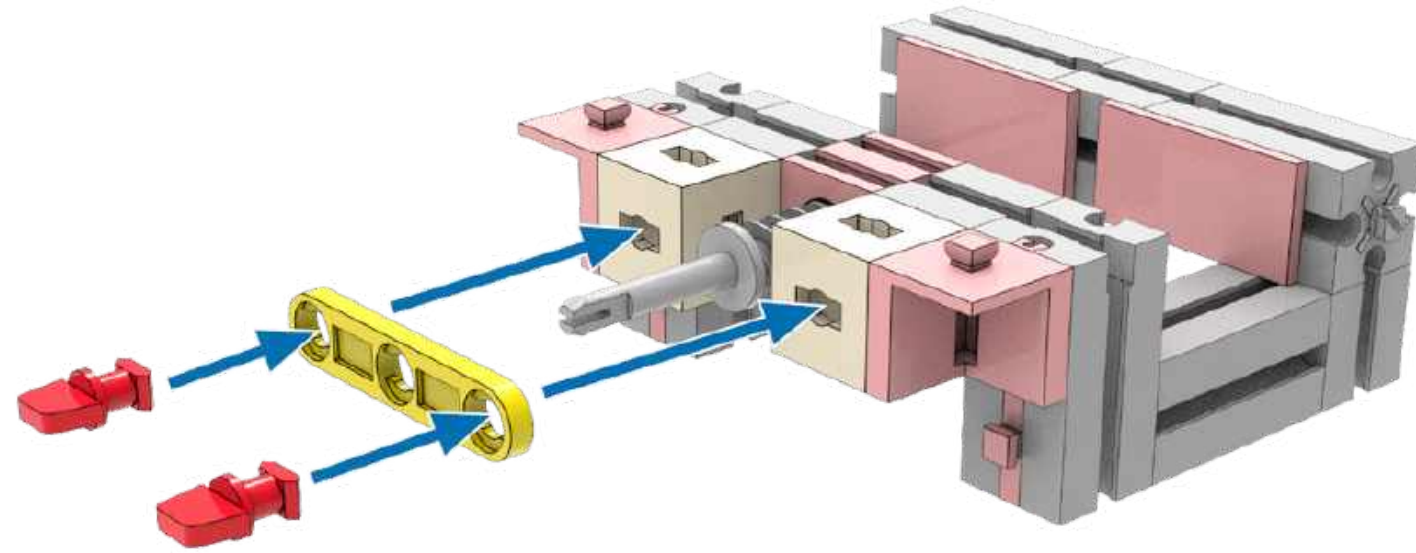
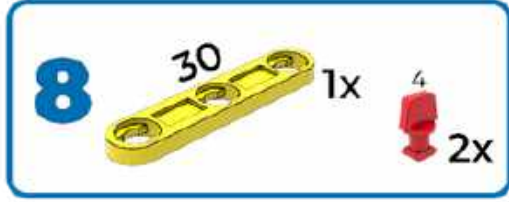

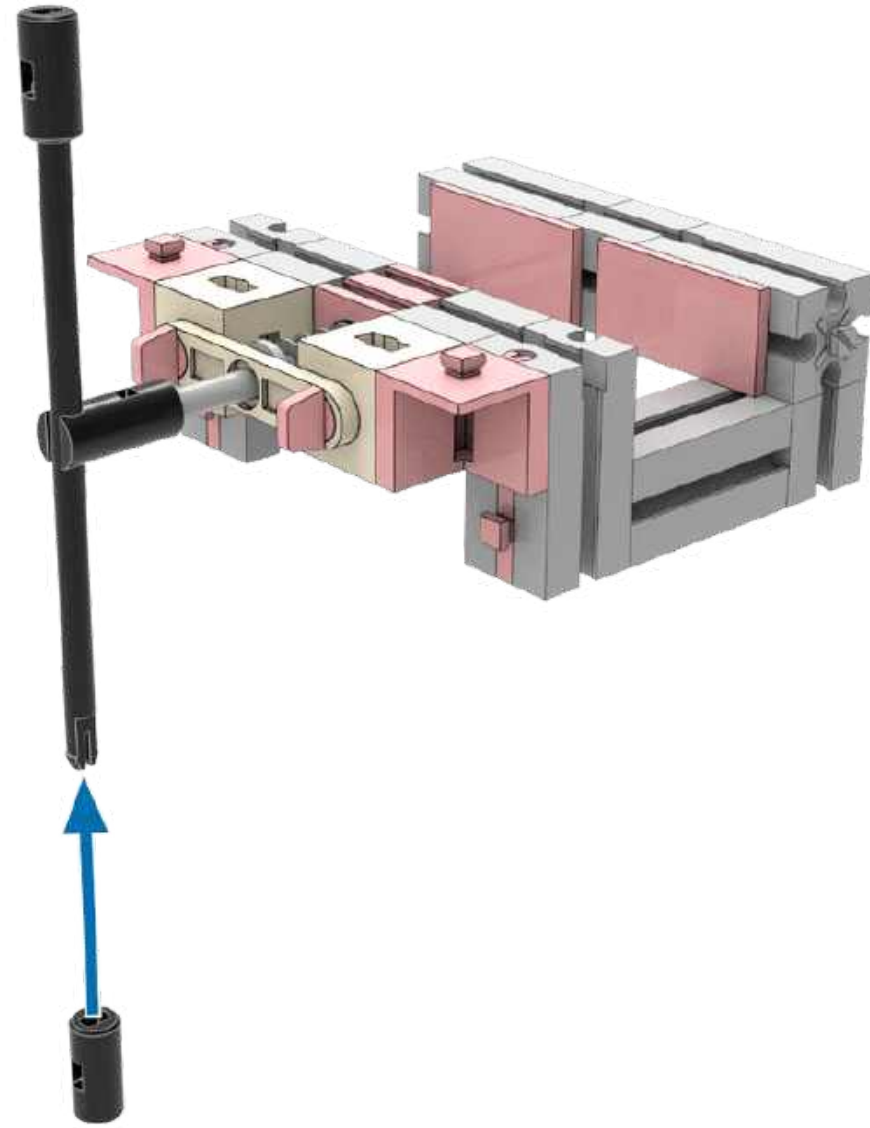

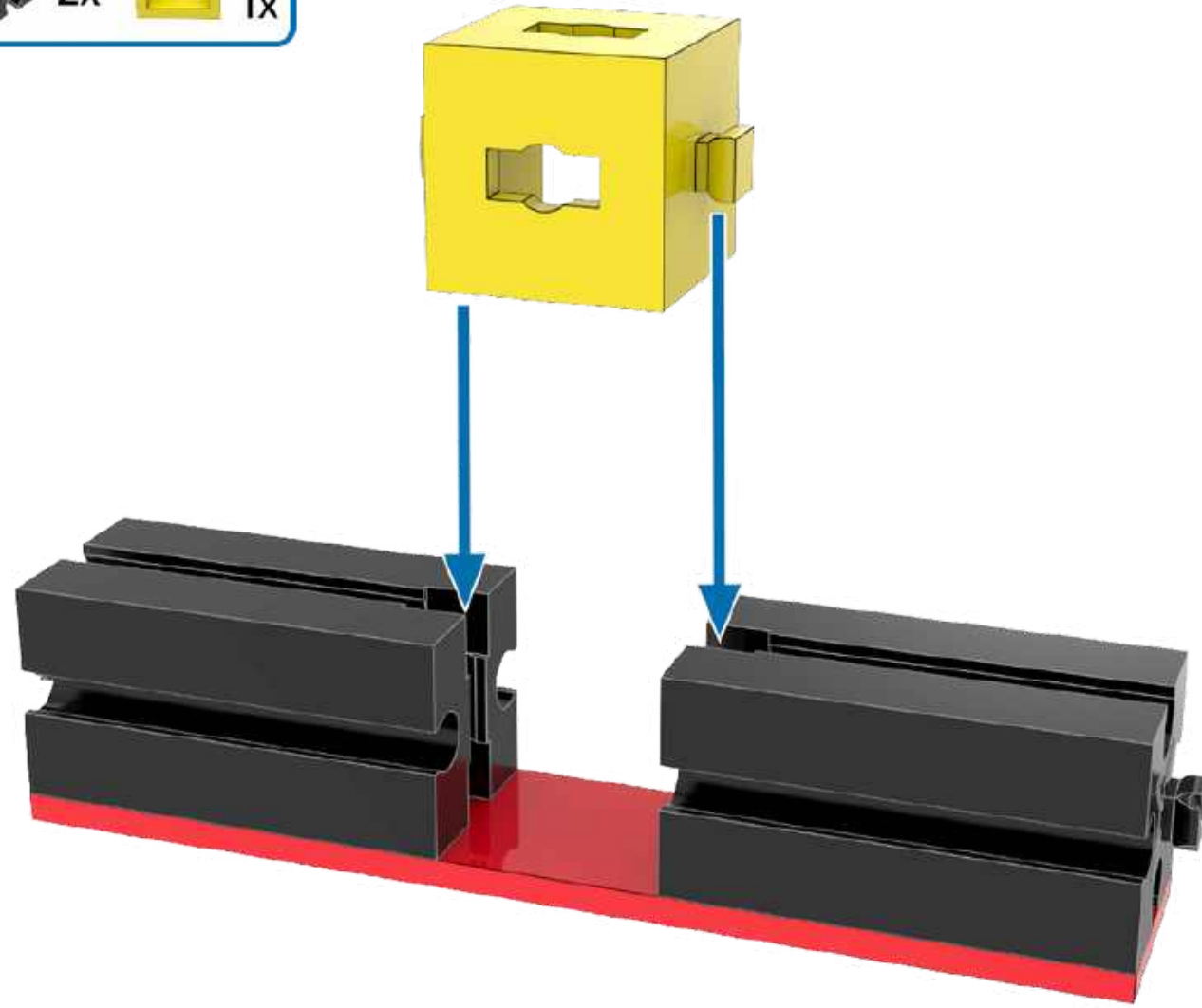
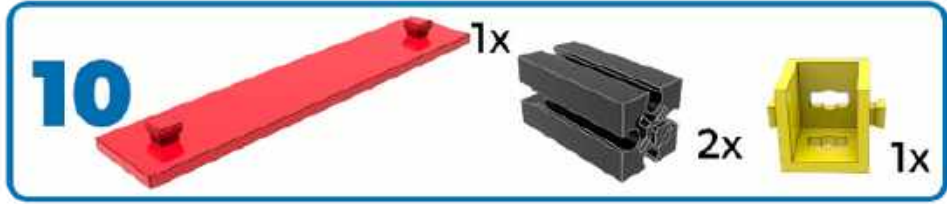



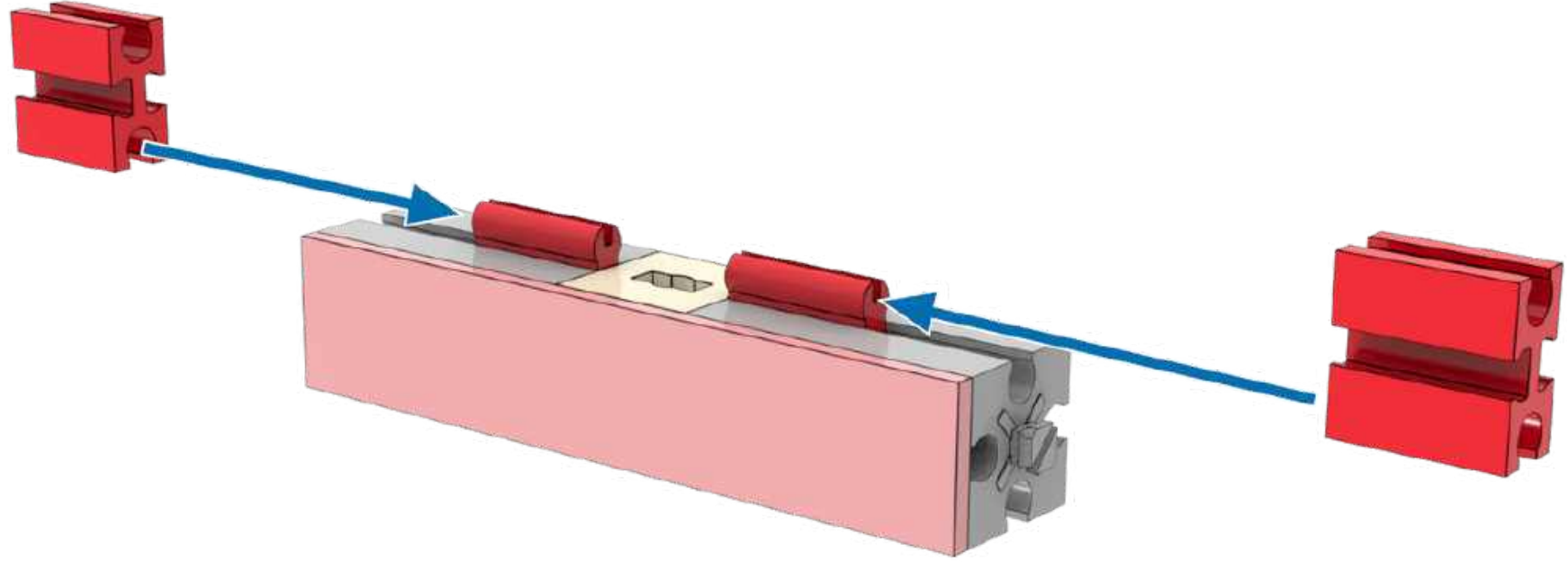

11 ¹⁵ 2x  2x  2x

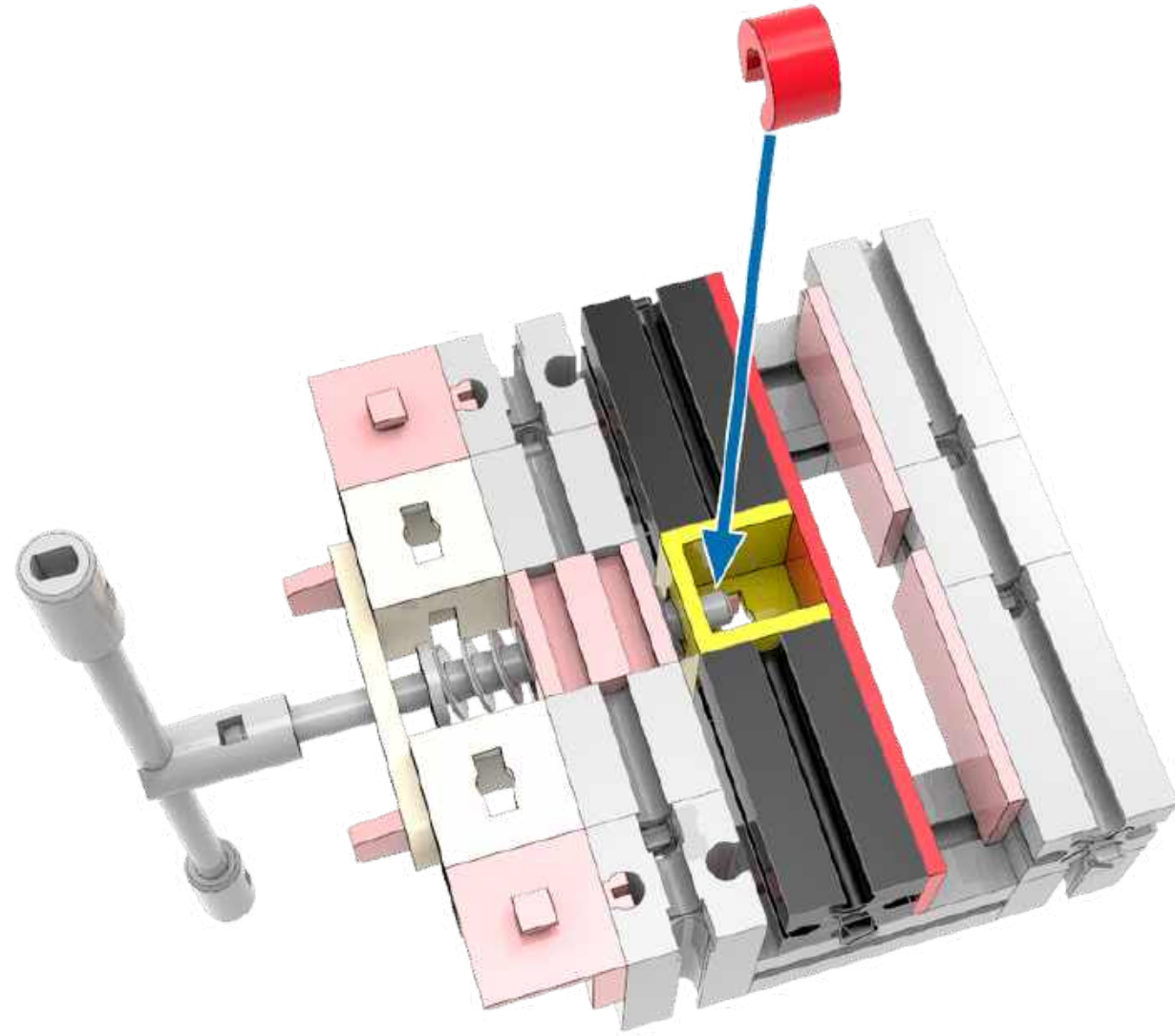

12  1x



13  2x  2x

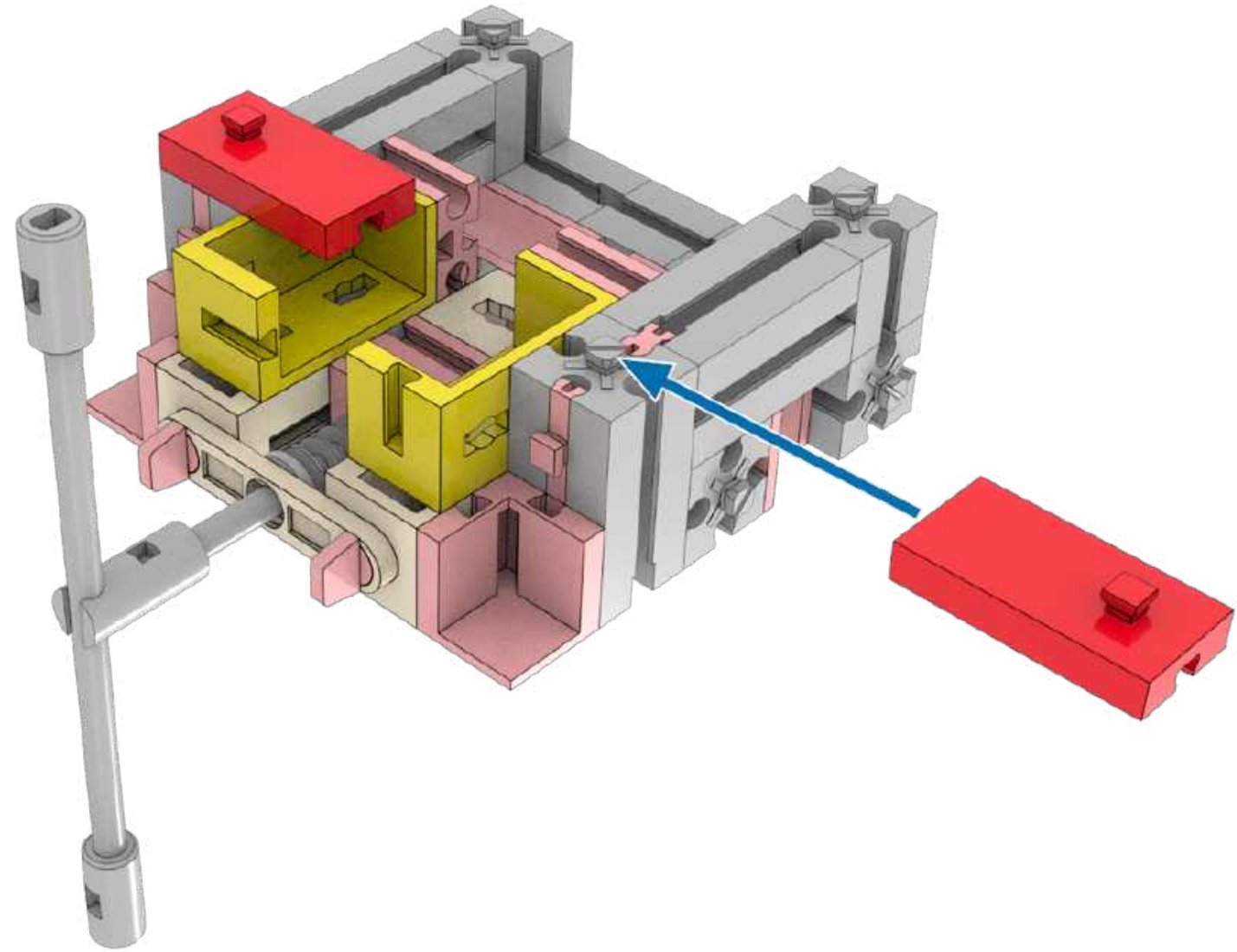

14  2x

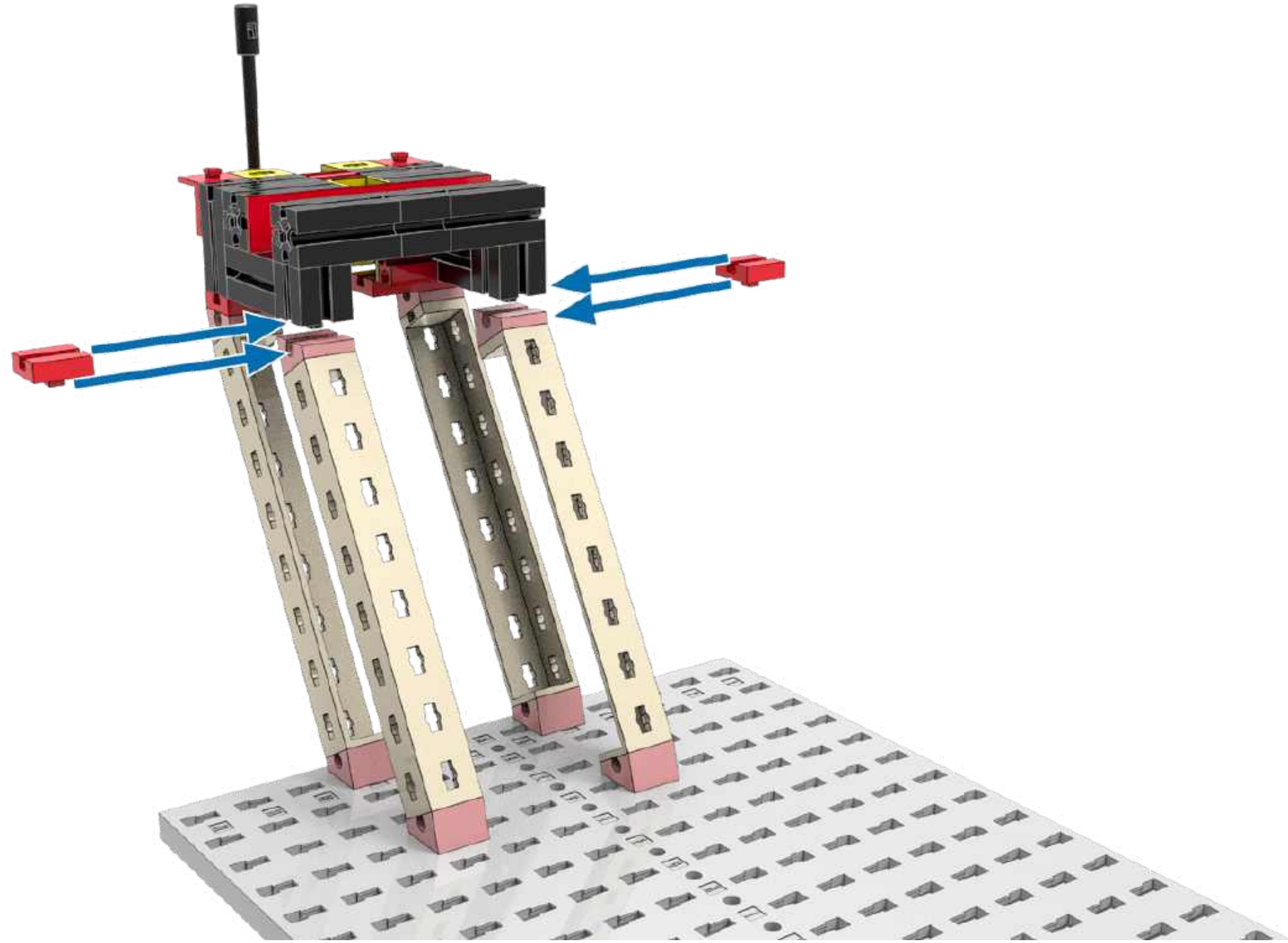

15

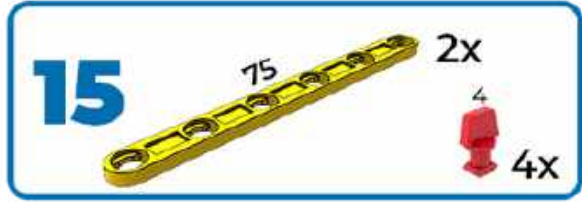

75 2x
4 4x

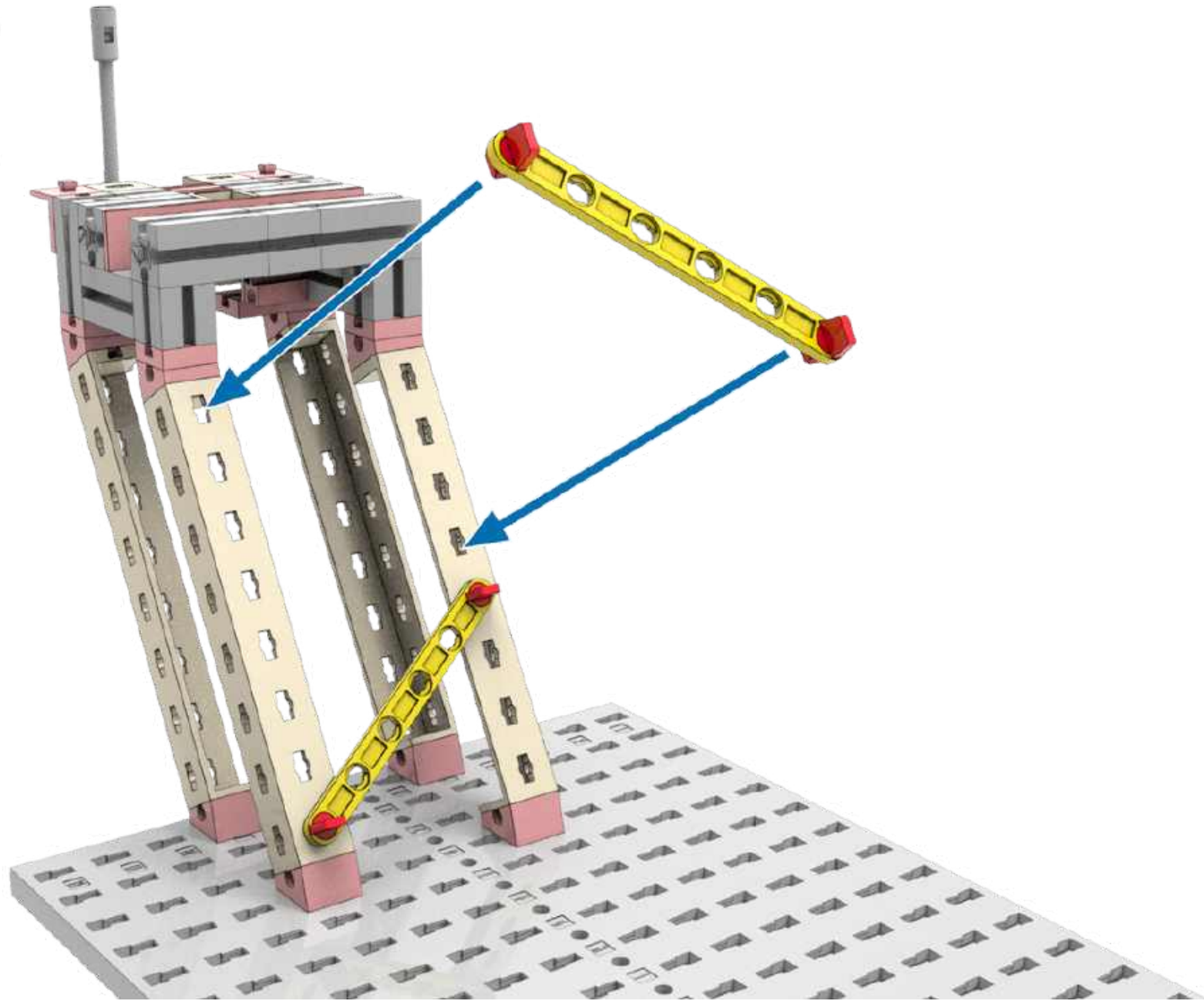

16 45 4x 4
8x

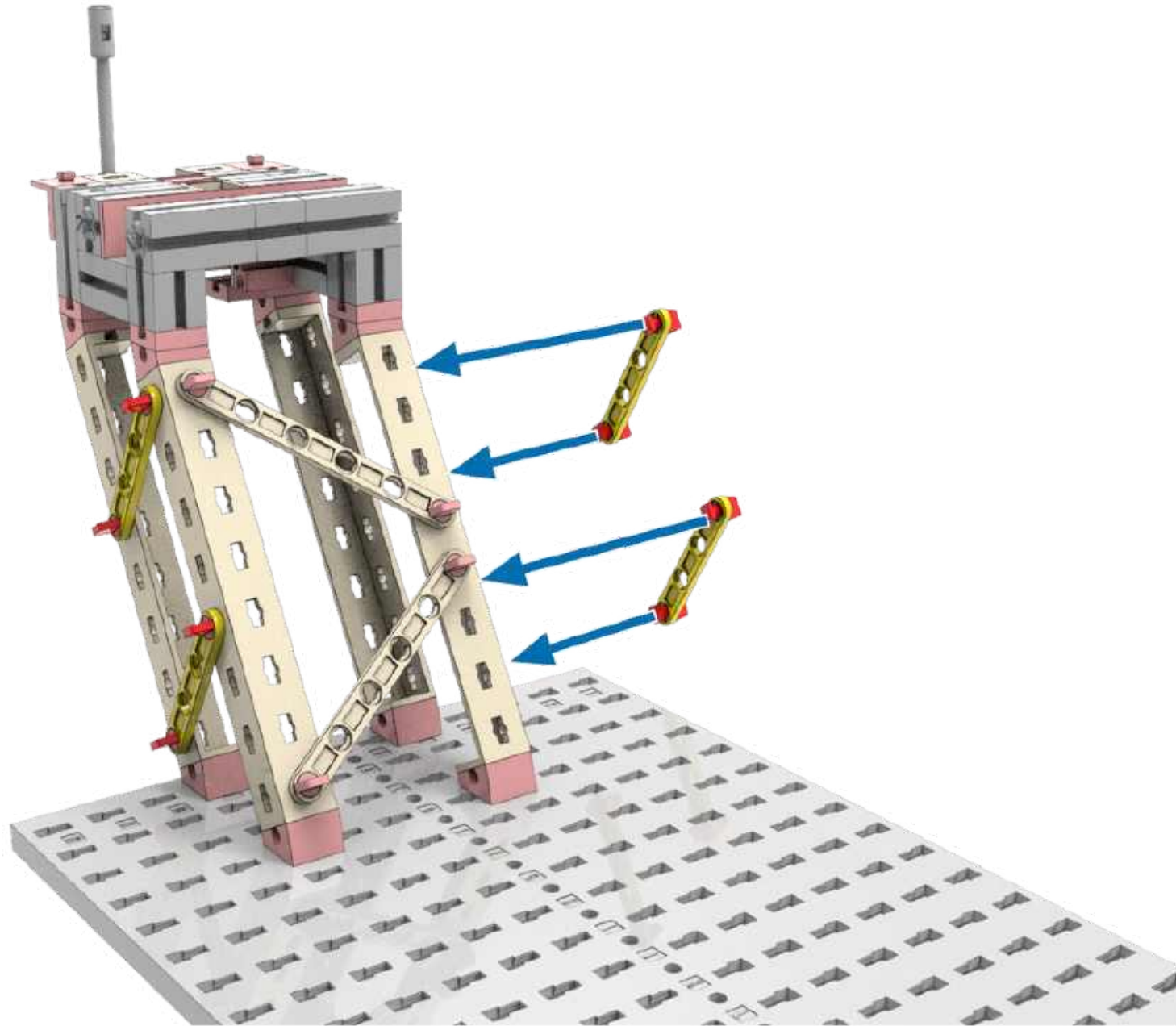

17

60

1x

2x

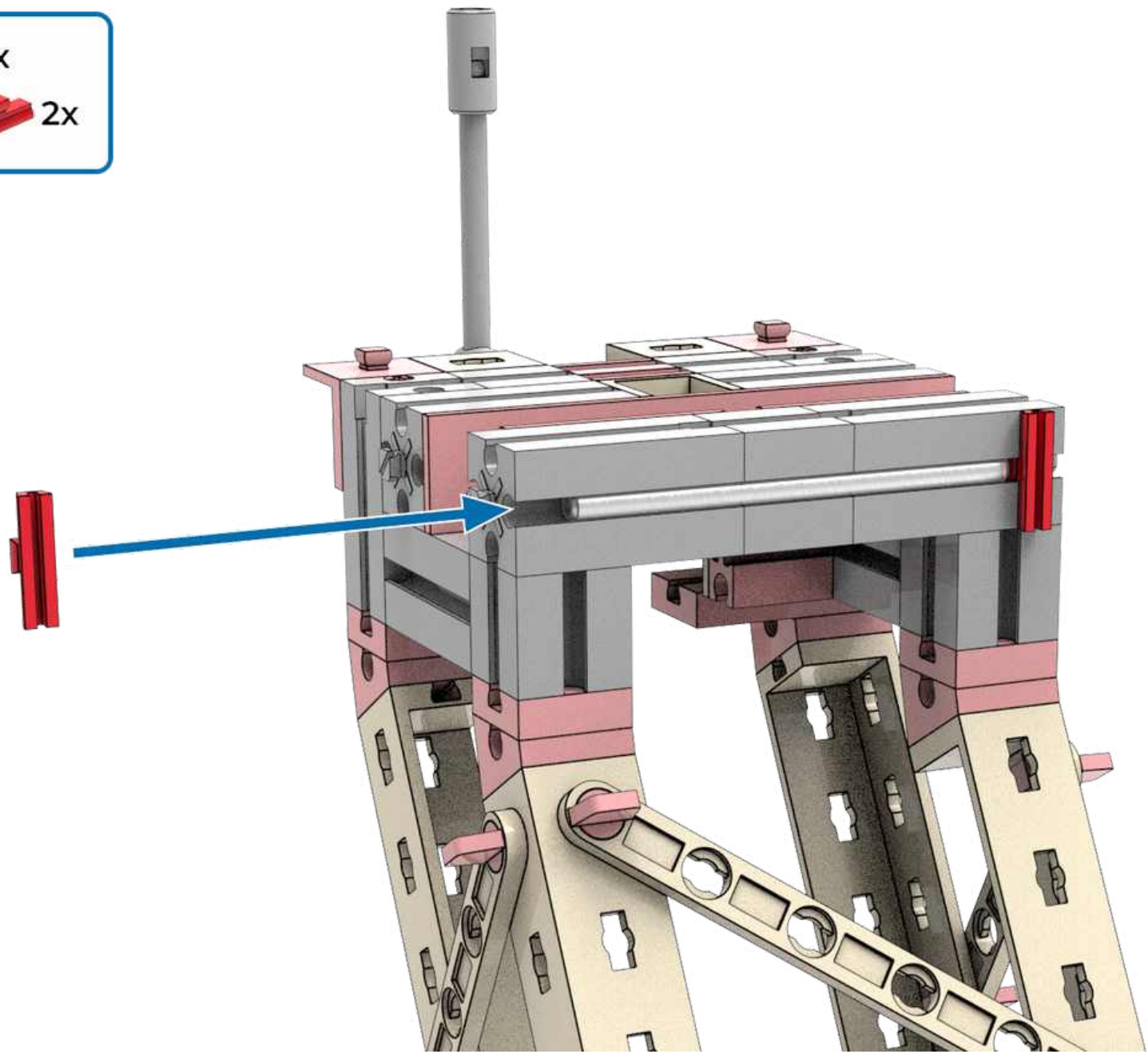

umbauen
modify
modifier
veranderen
modificar
modificar
modificare
переделать
改装

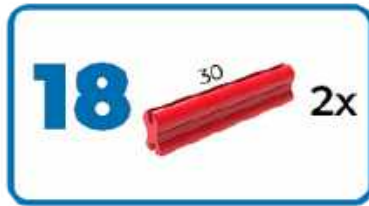

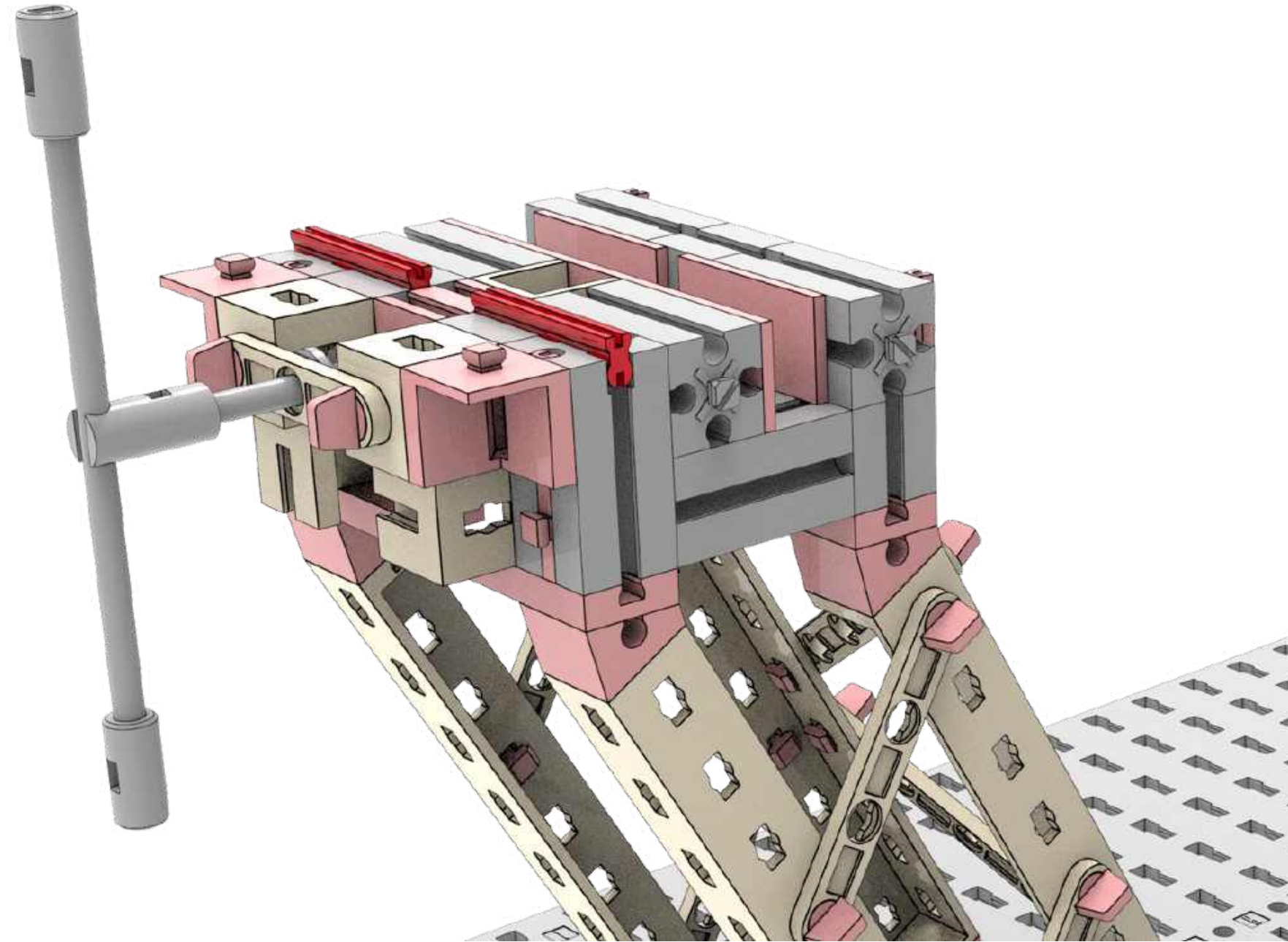

umbauen
modify
modifier
veranderen
modificar
modificar
modificare
переделать
改装



19  1x  2x

umbauen
modify
modifier
veranderen
modificar
modificar
modificare
переделать
改装

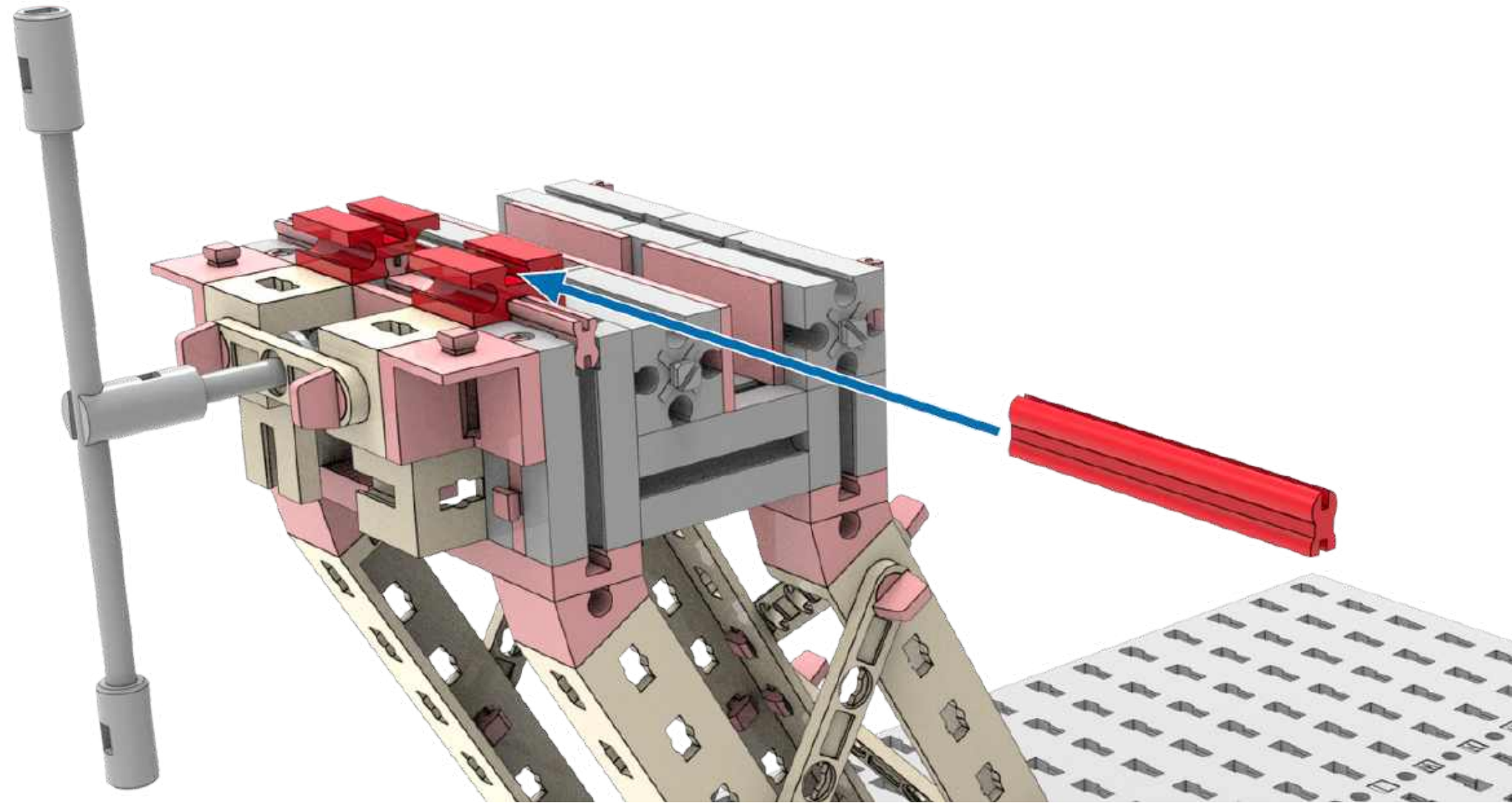

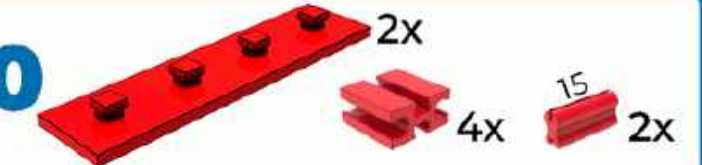
20  2x
4x
15
2x

umbauen
modify
modifier
veranderen
modificar
modificar
modificare
переделать
改装

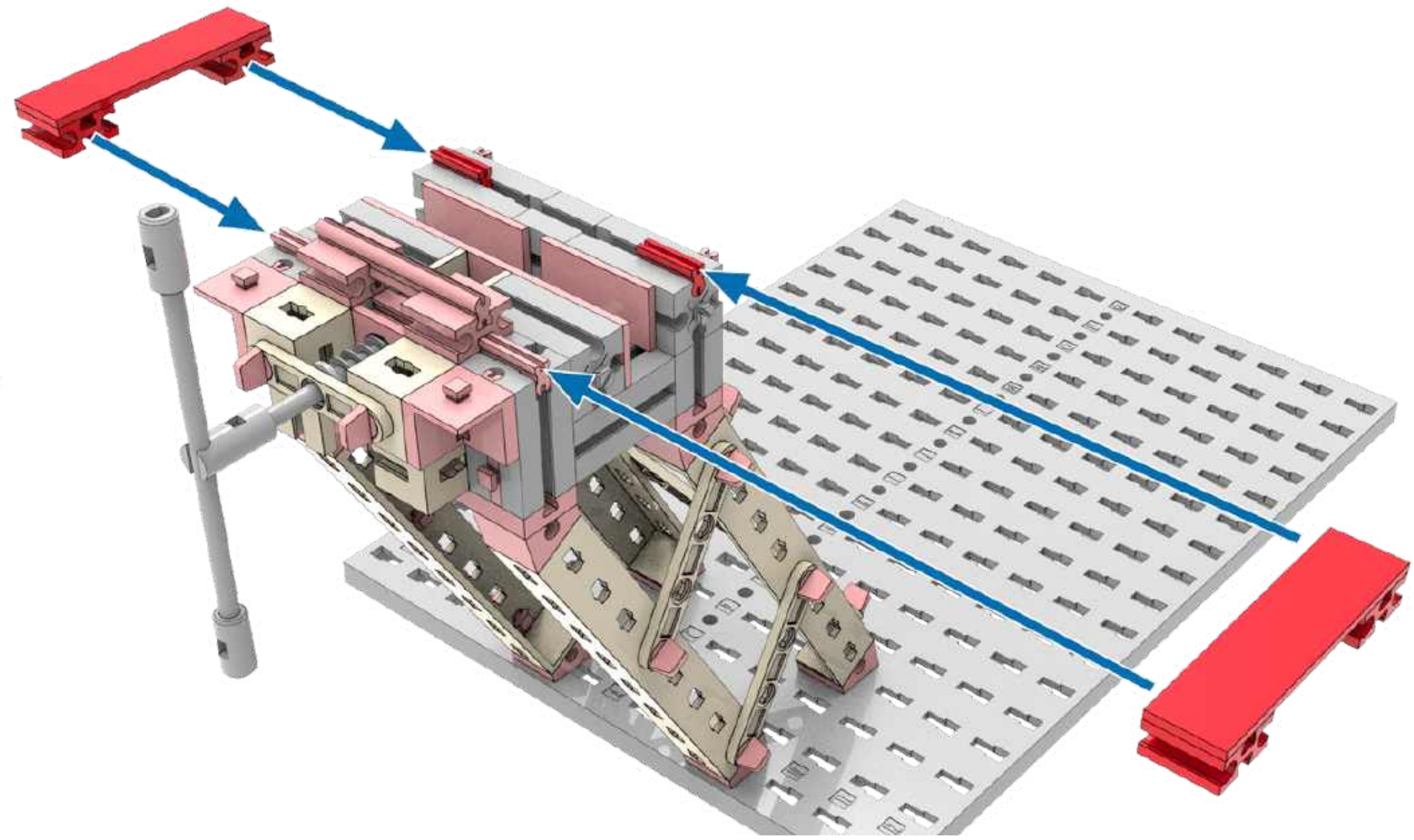

Warenautomat

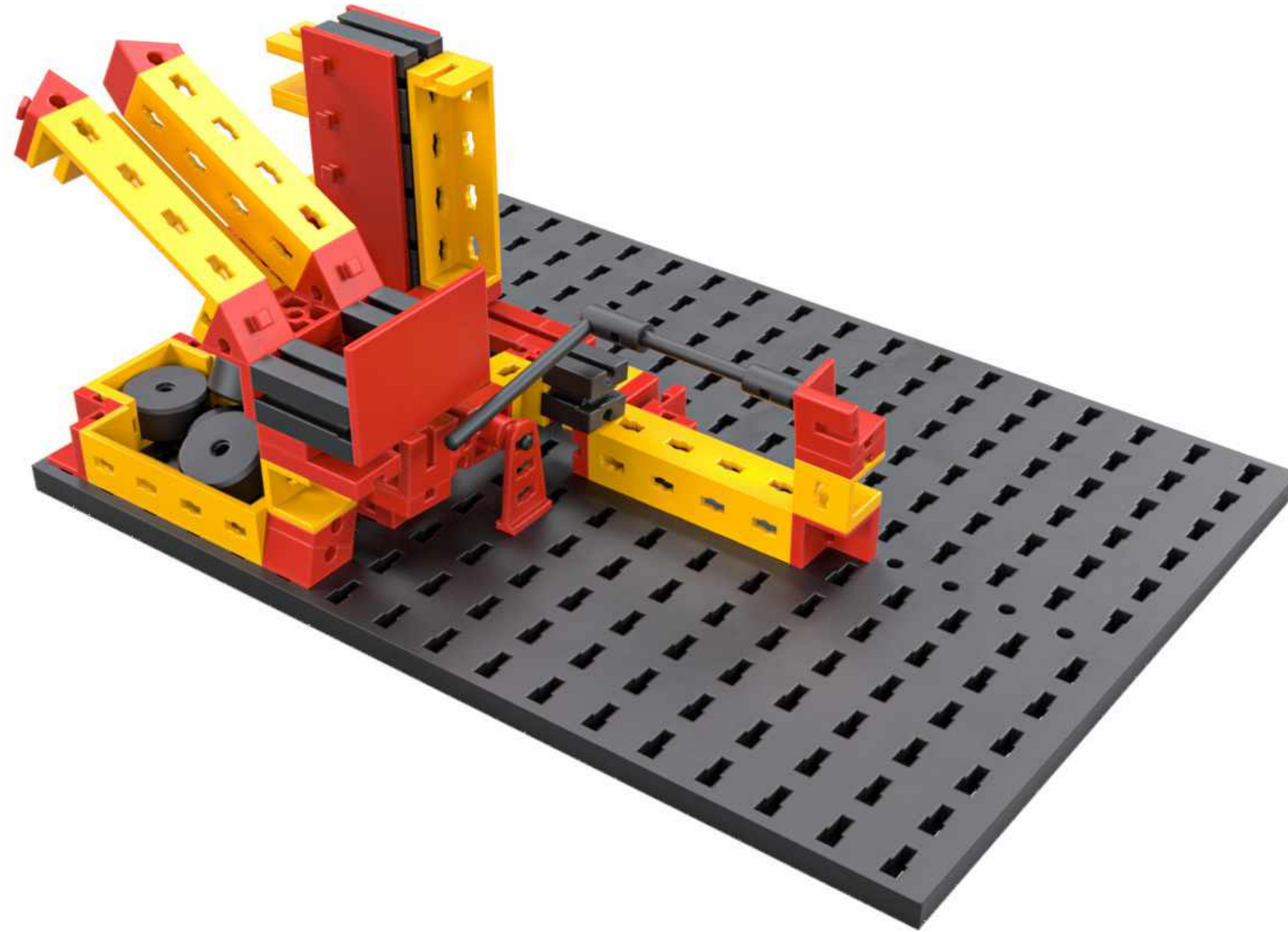

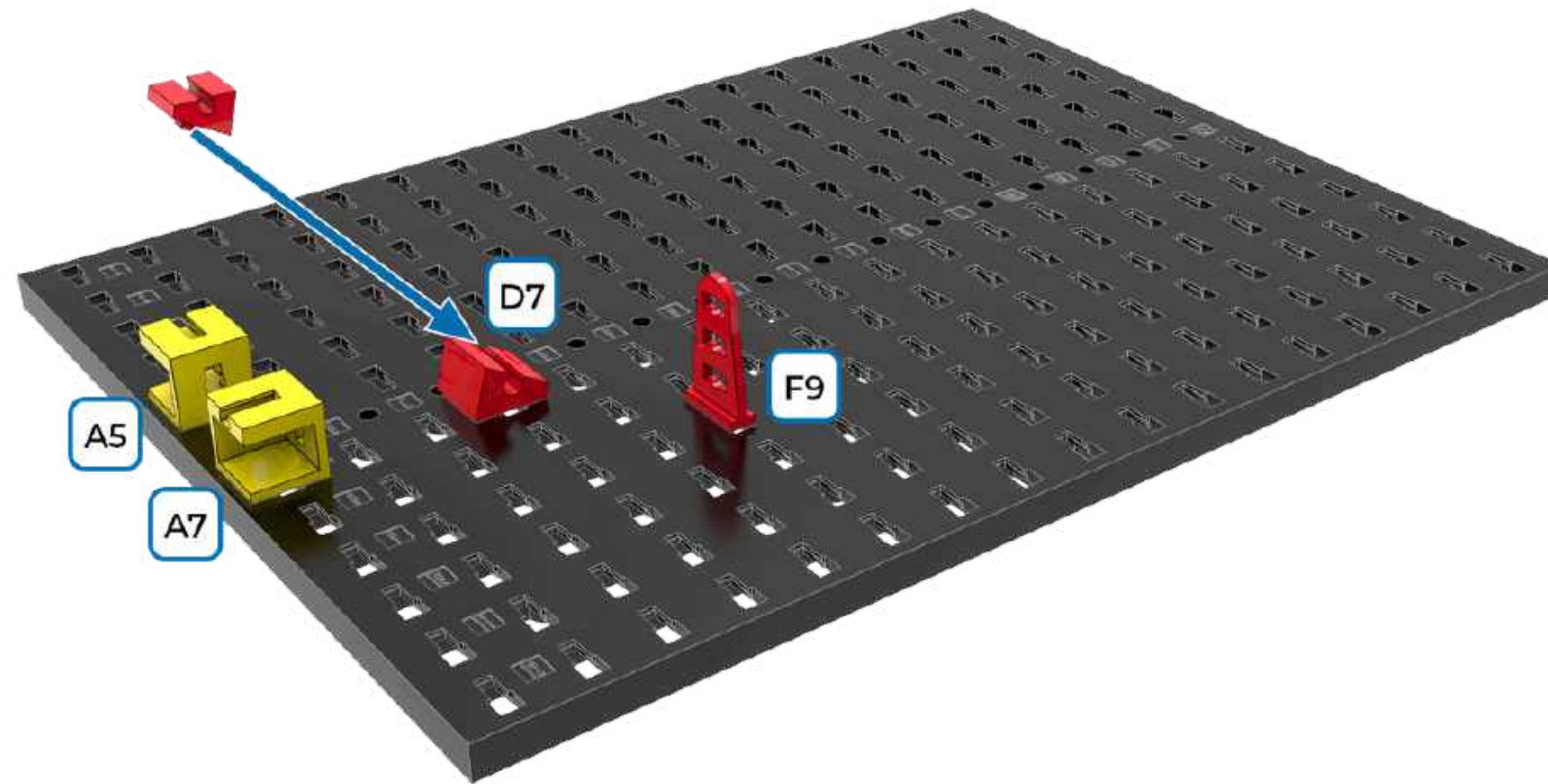
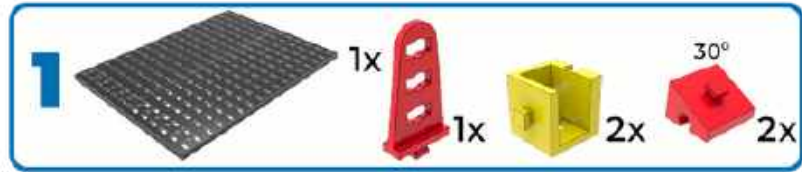

2  3x  2x  1x

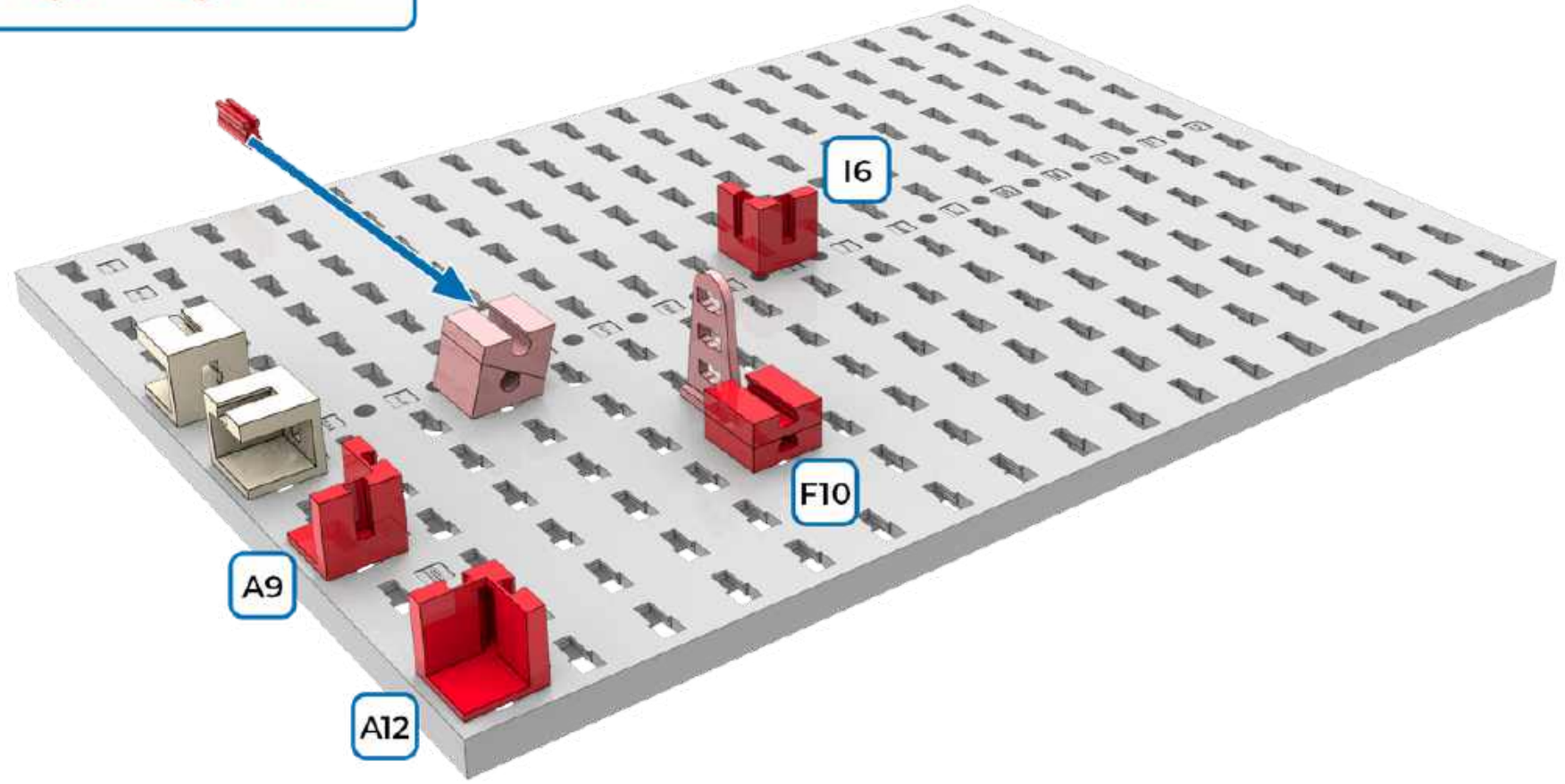

3  1x  2x  2x

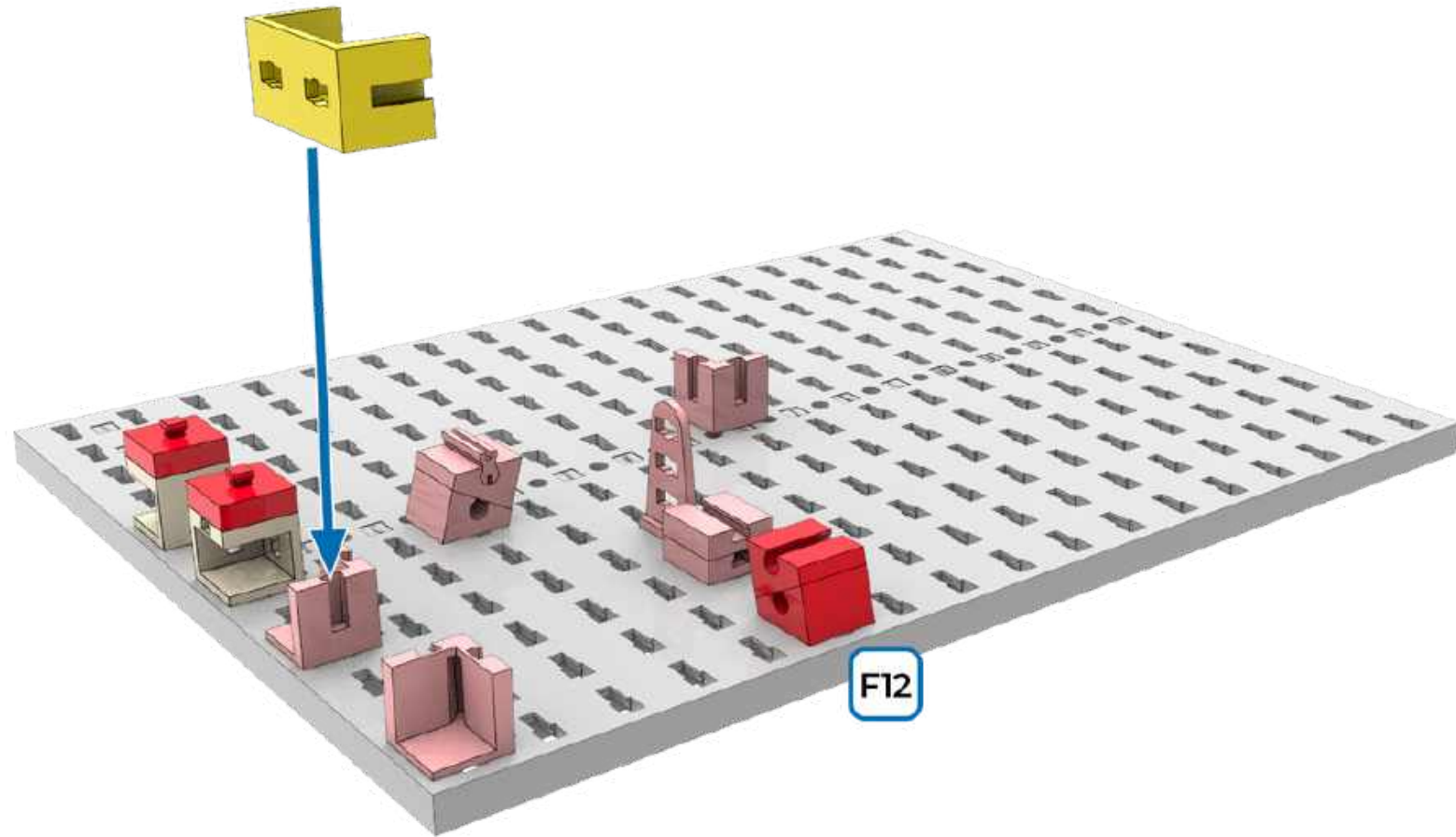

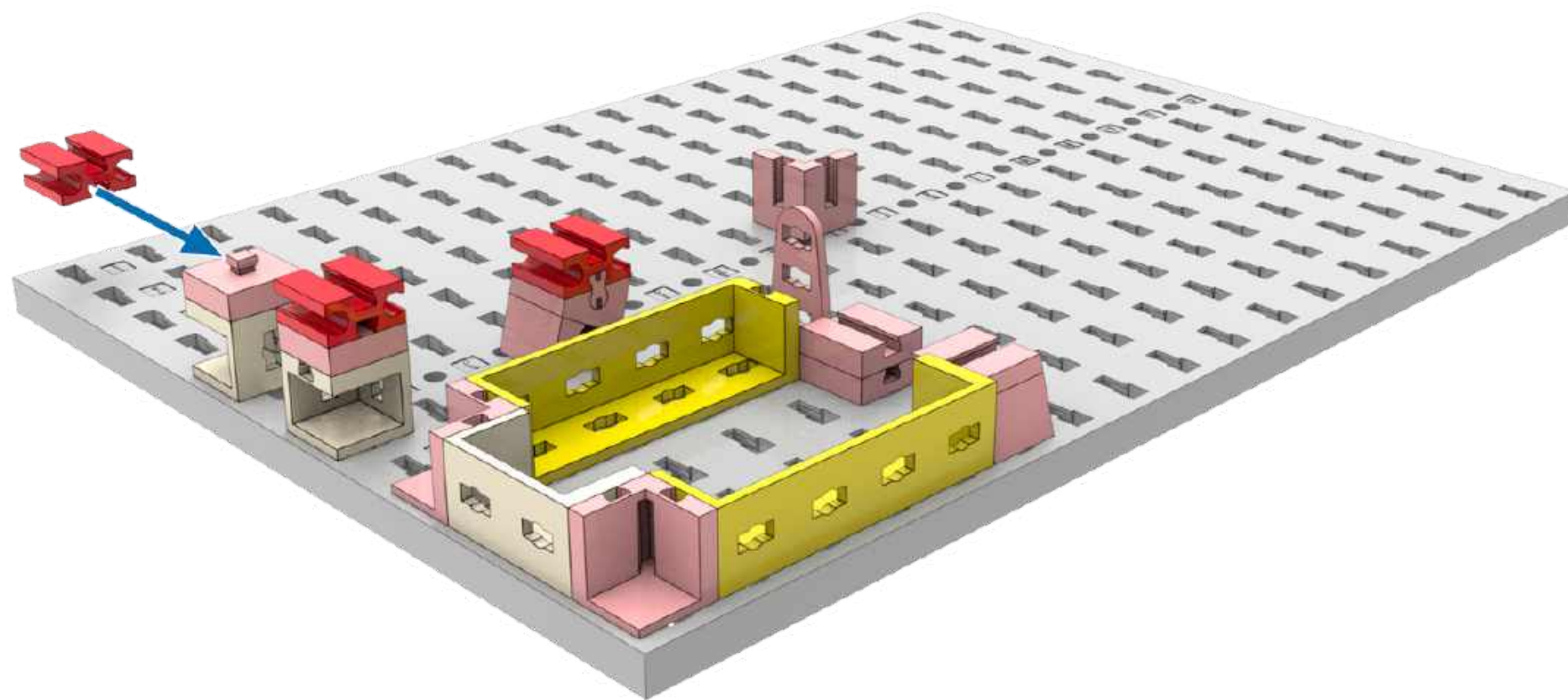

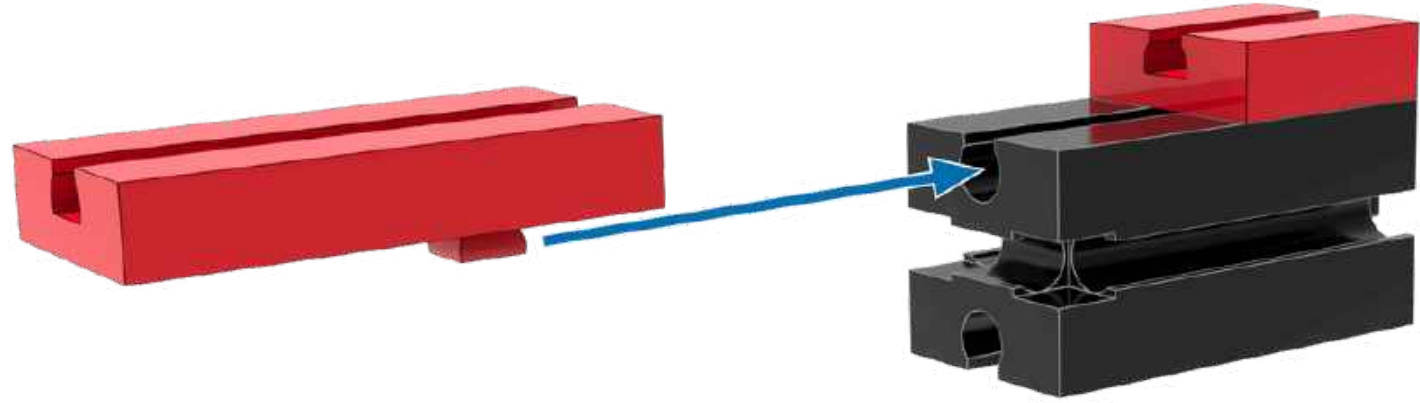

5  1x  1x  1x

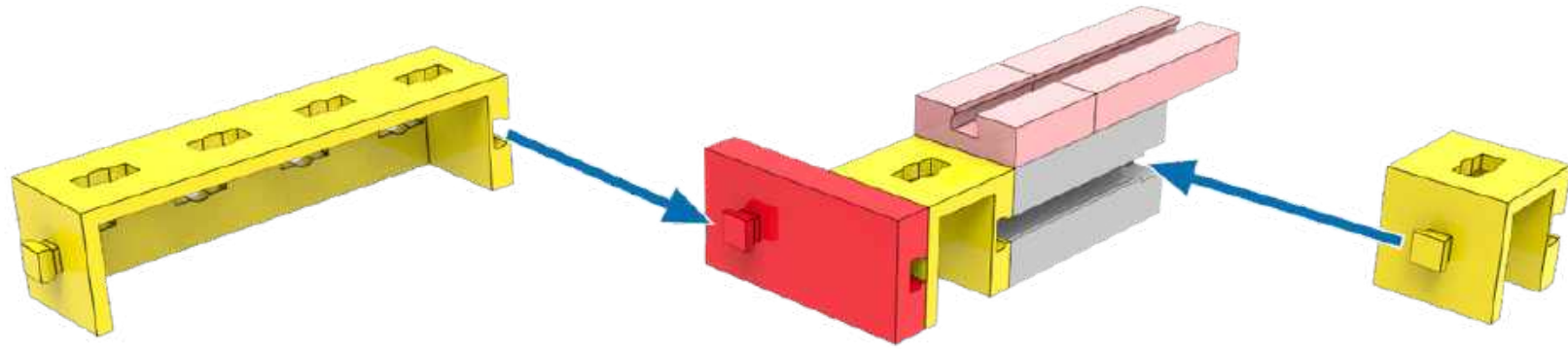

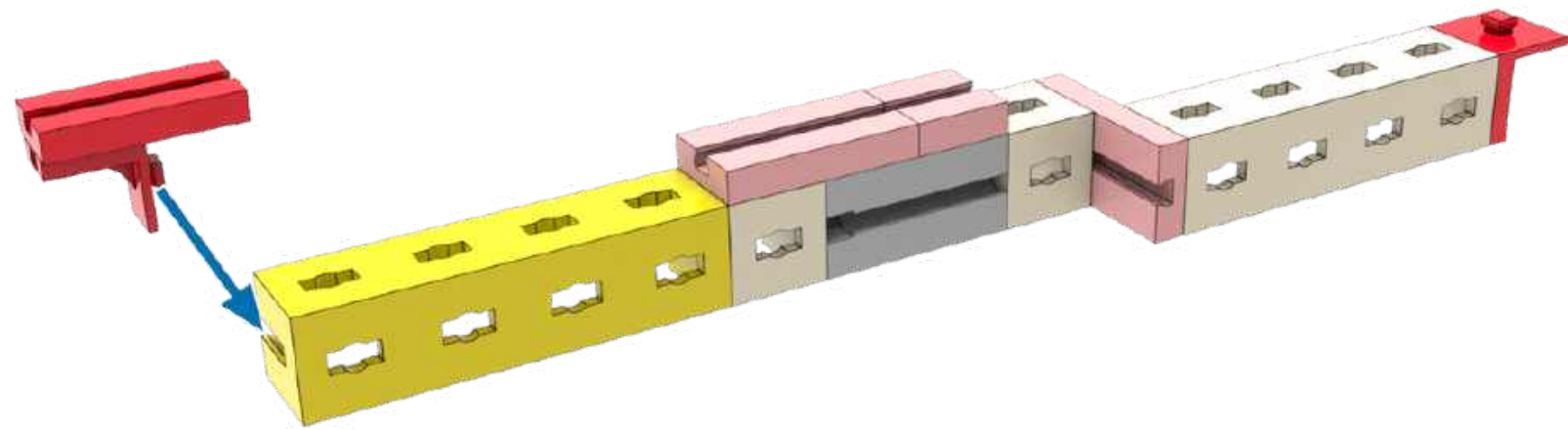
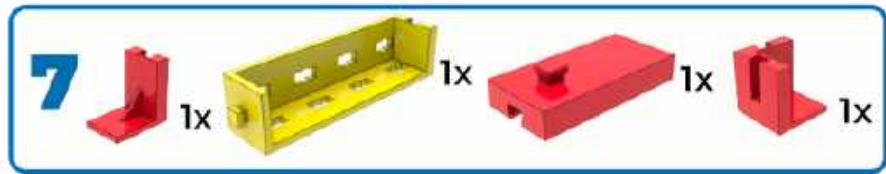





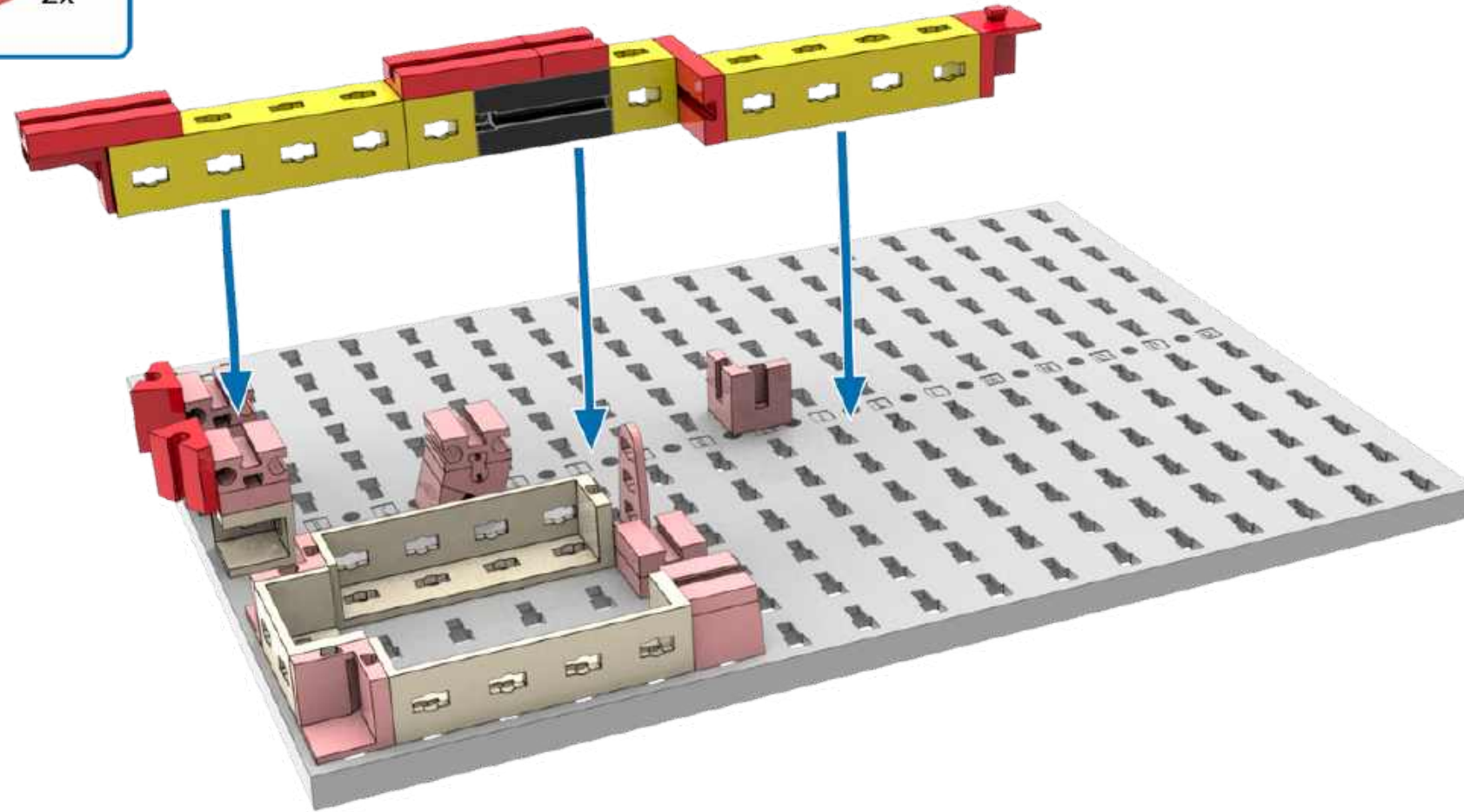

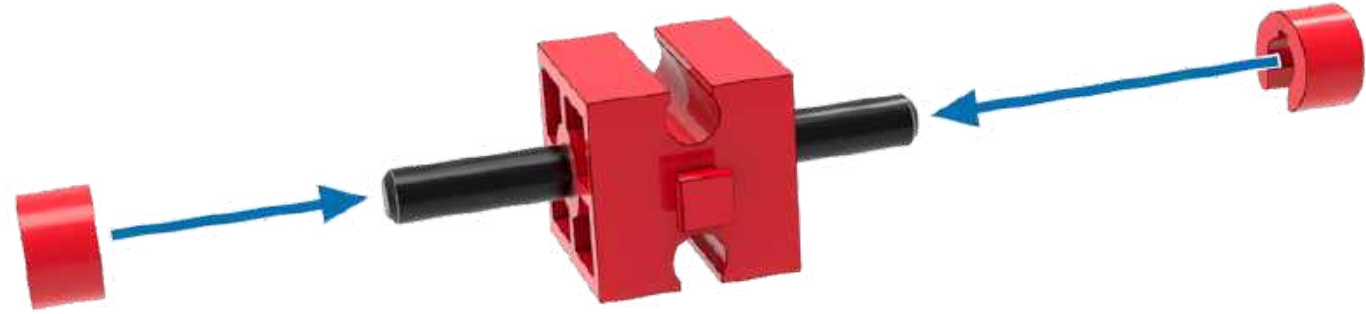
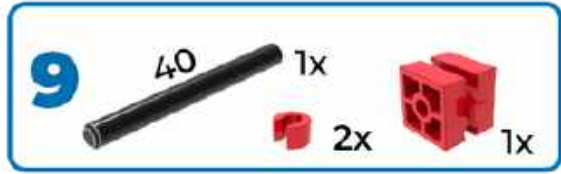
8  2x





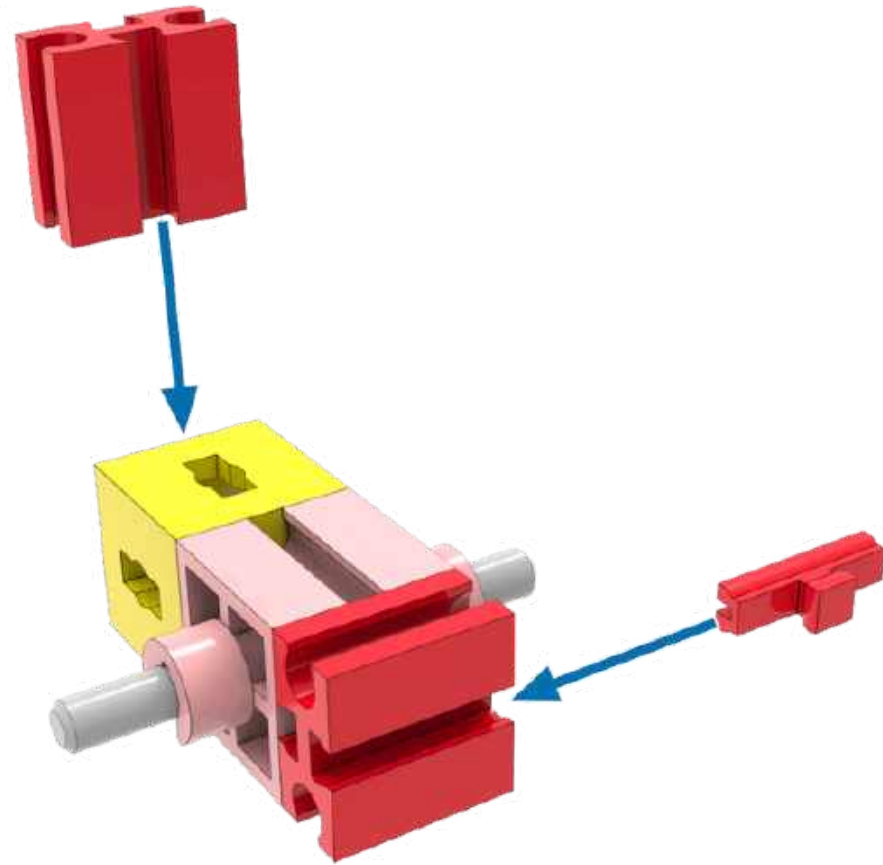

10  2x  1x  1x

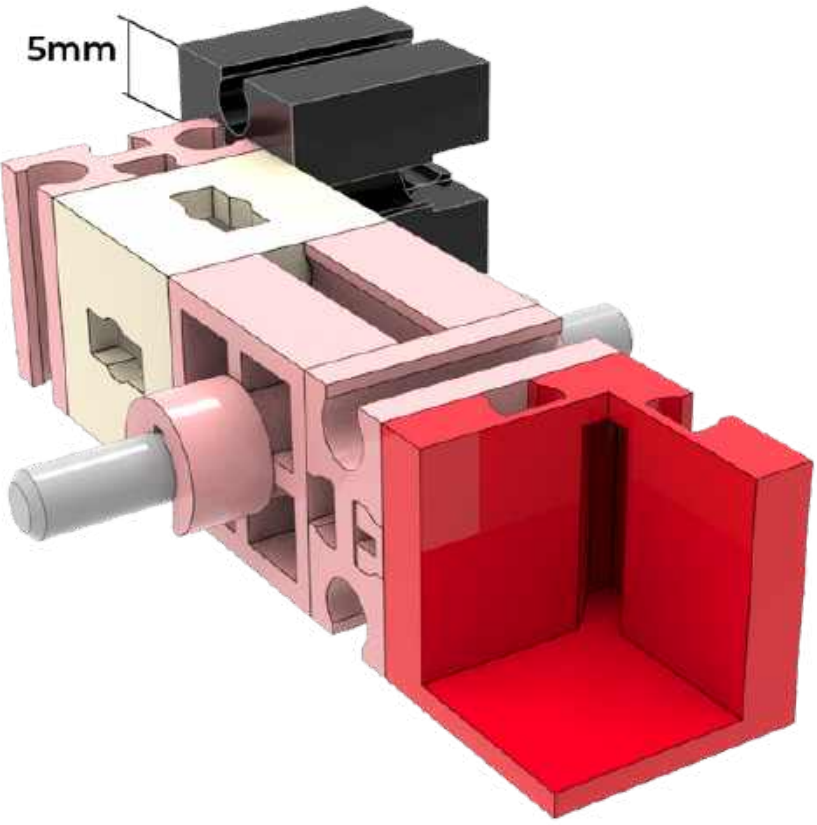
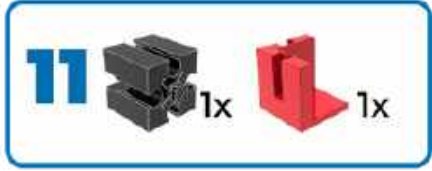



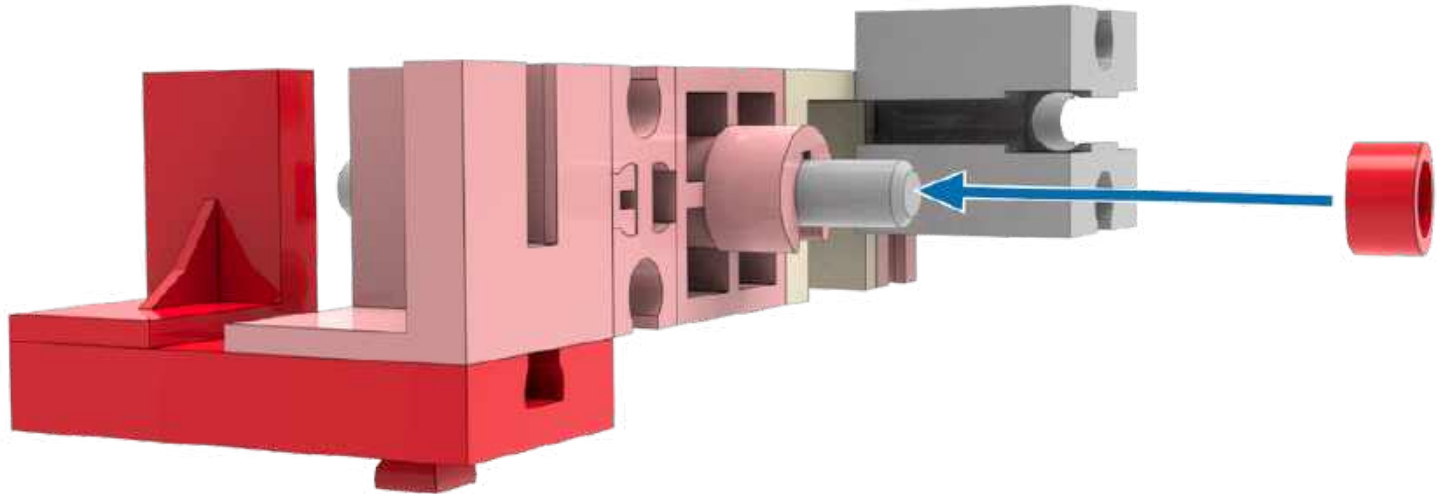

12  1x  1x  1x

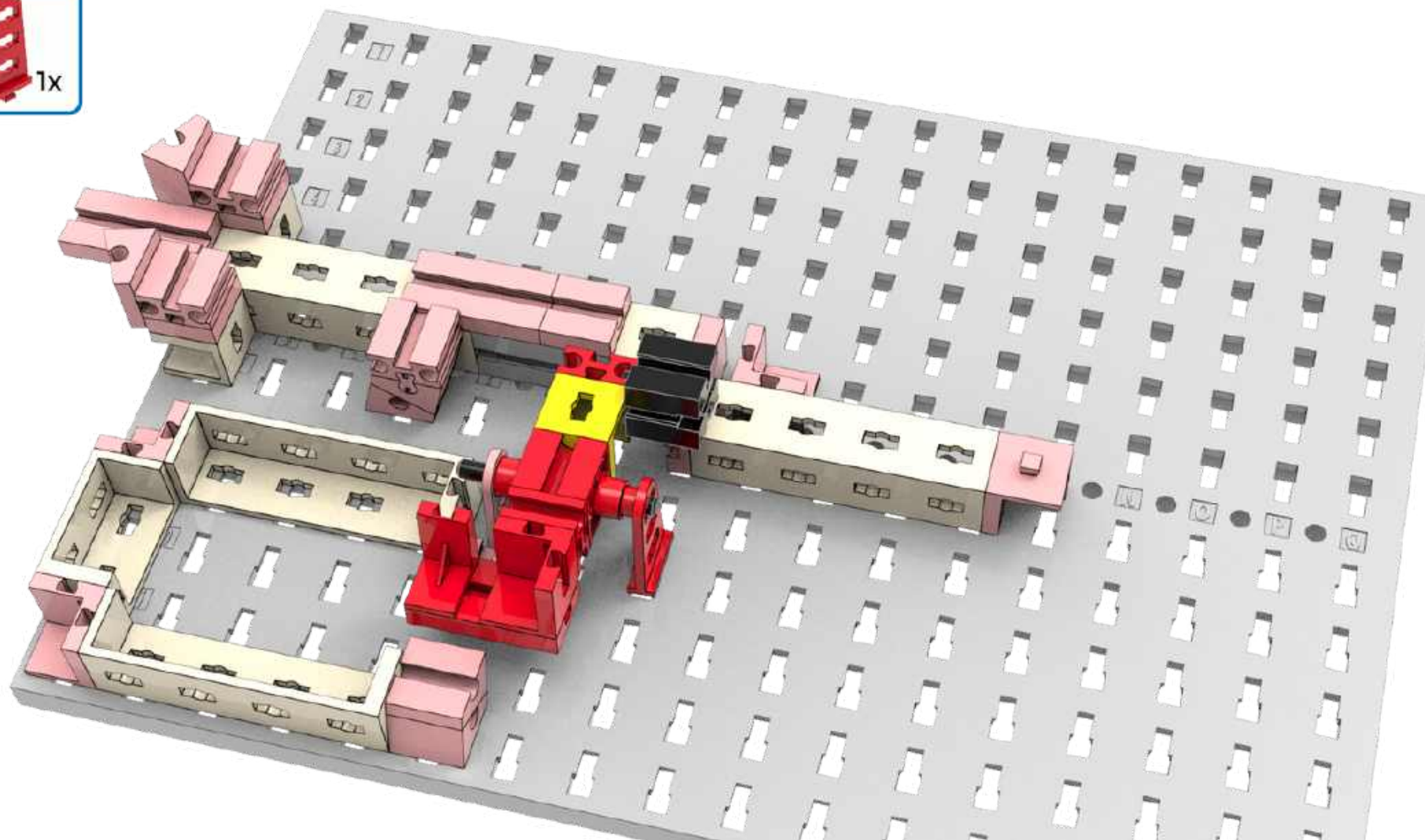

13  1x

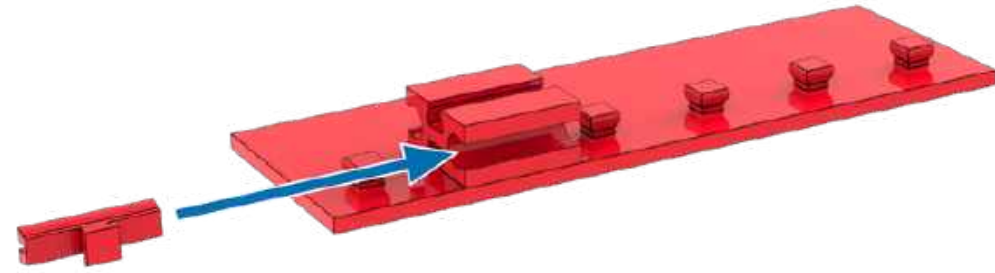
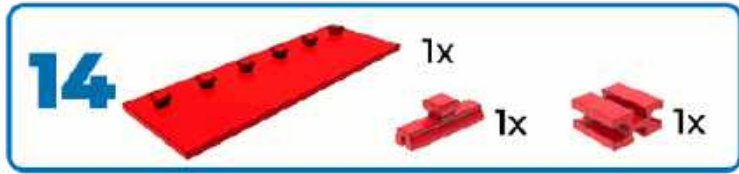





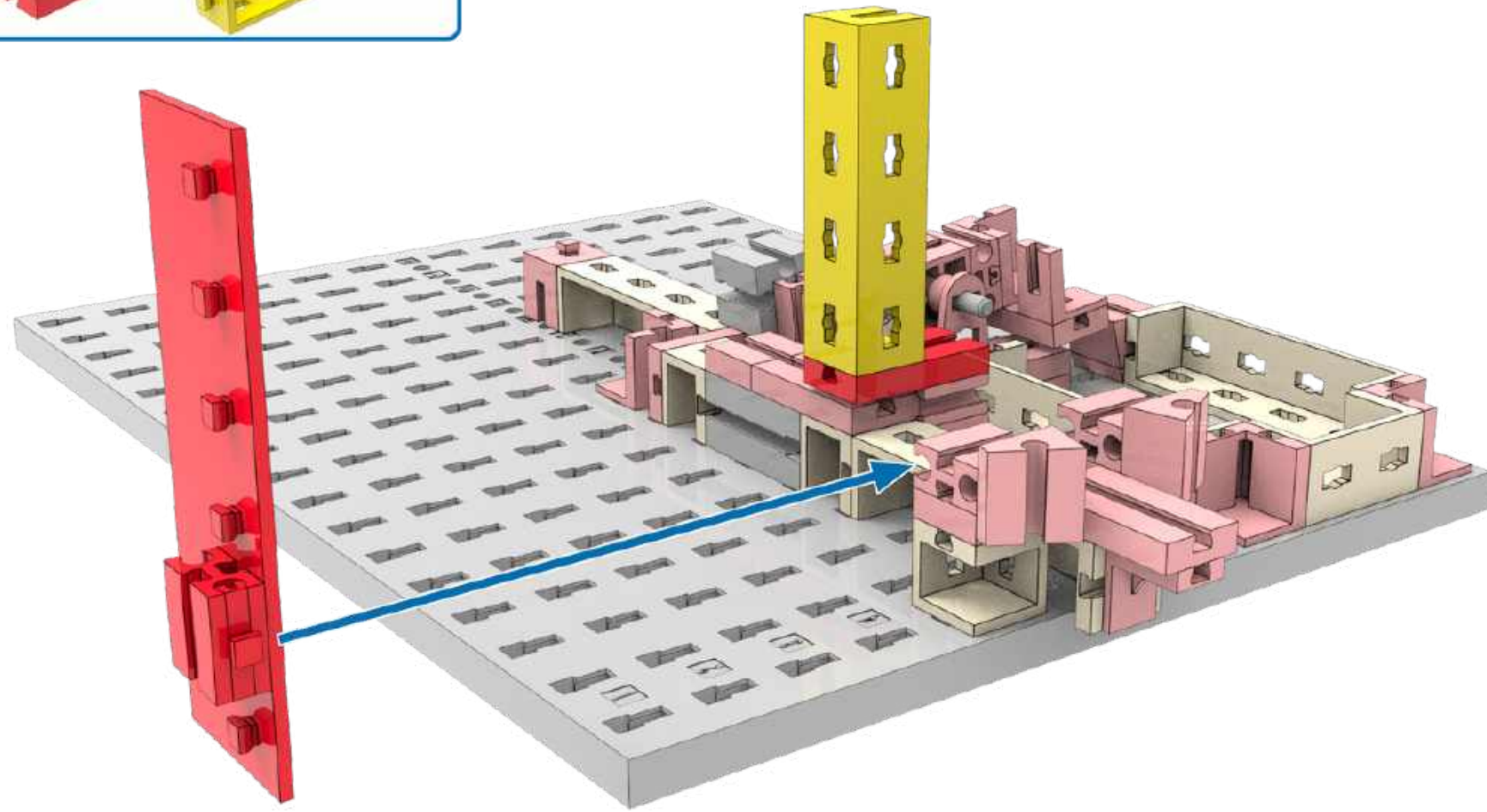

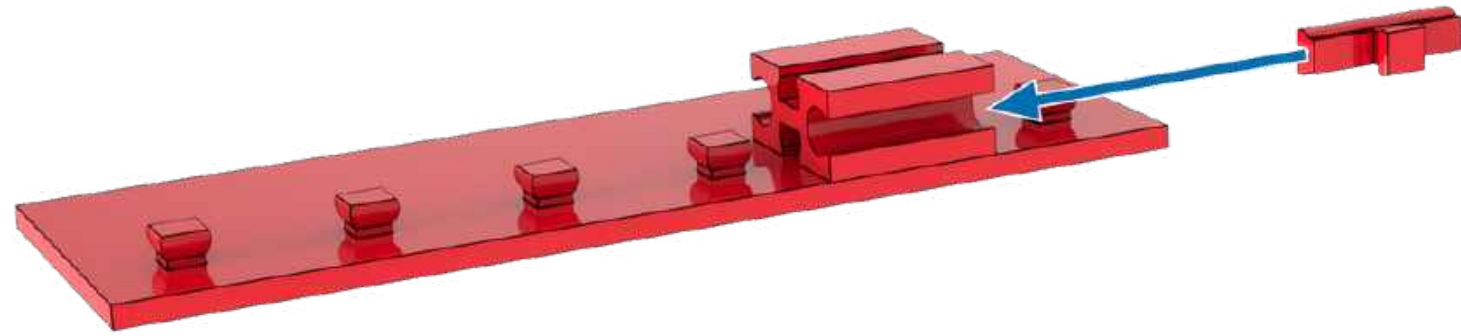
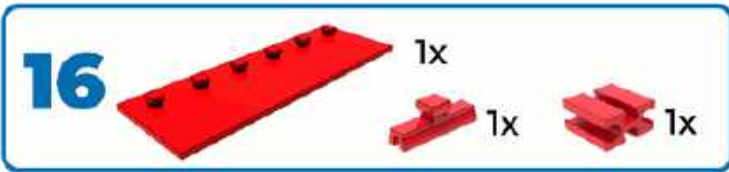



15  1x  1x

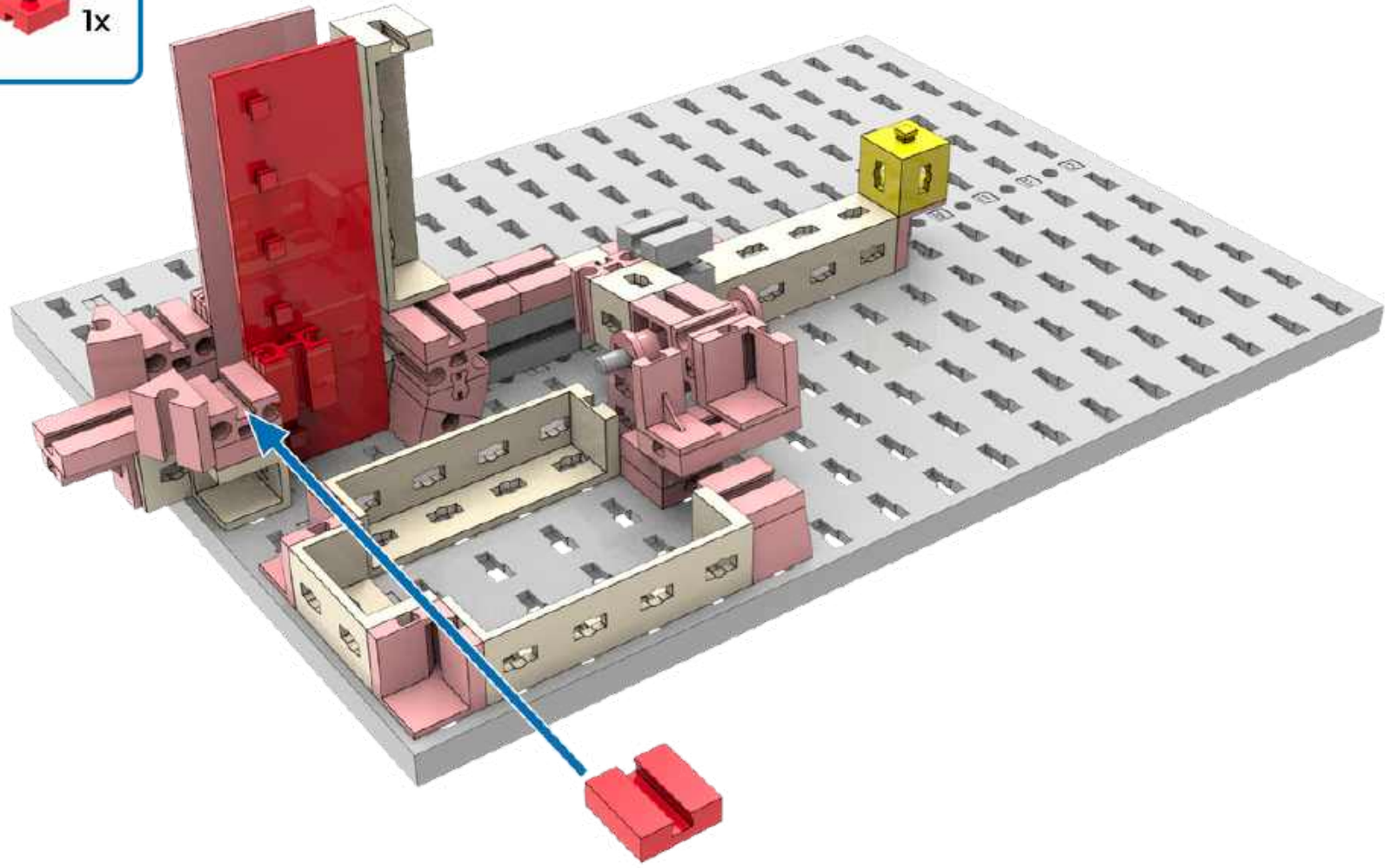





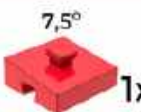

17  1x  1x

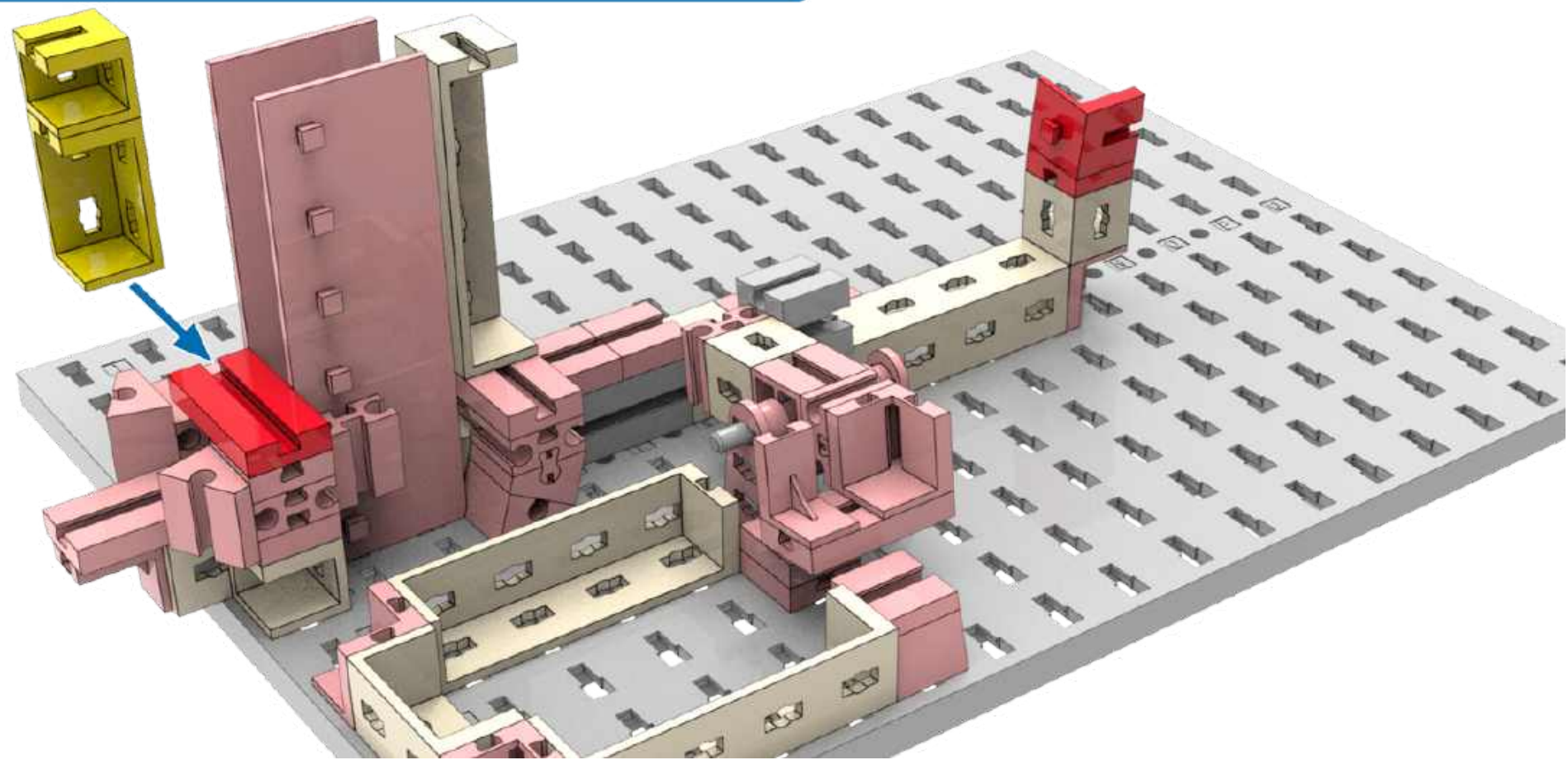

18  1x  1x  1x  1x  1x



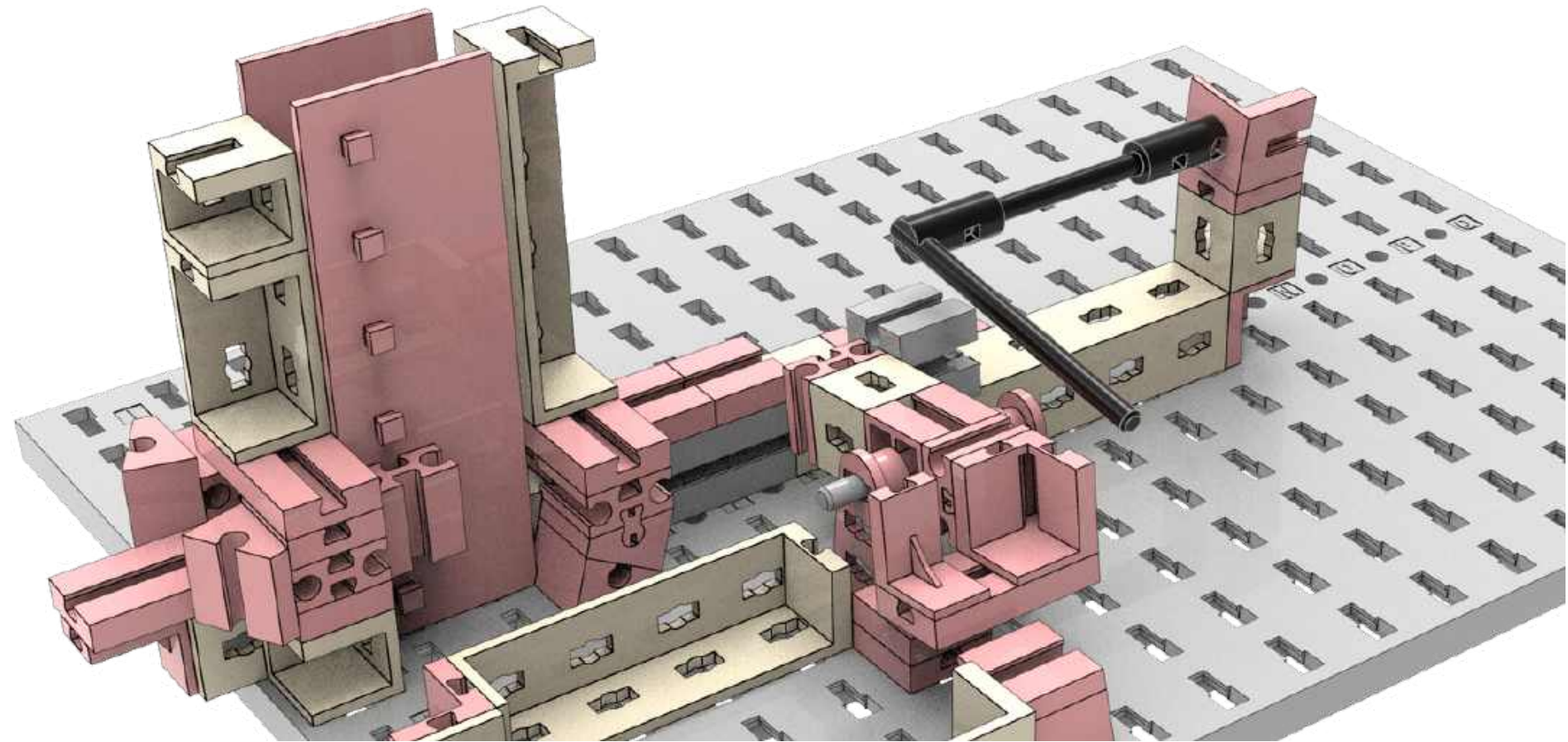

19  2x  1x  1x

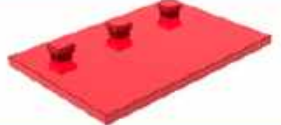

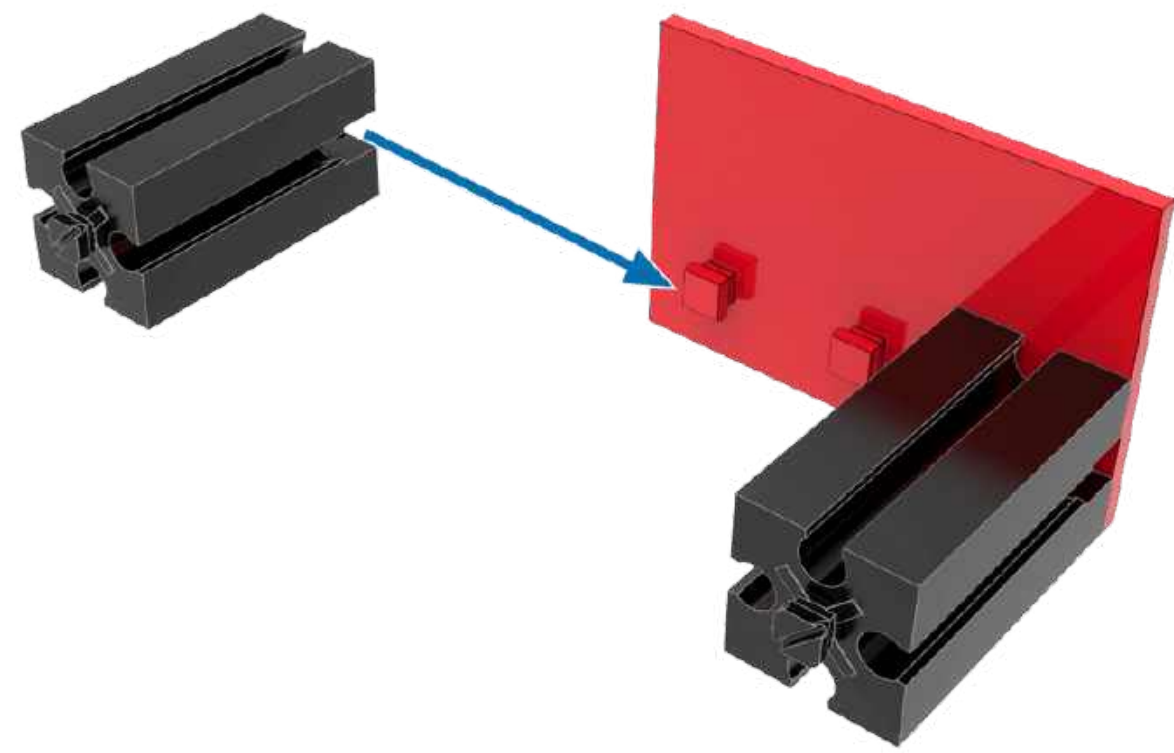



20  2x  1x

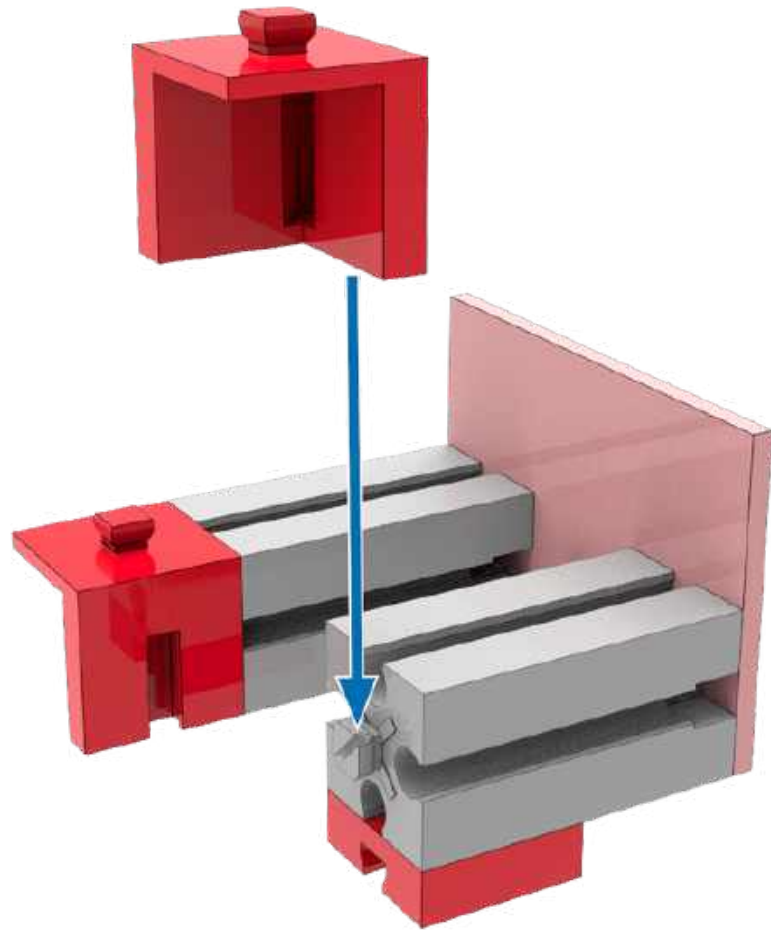

21  2x  1x



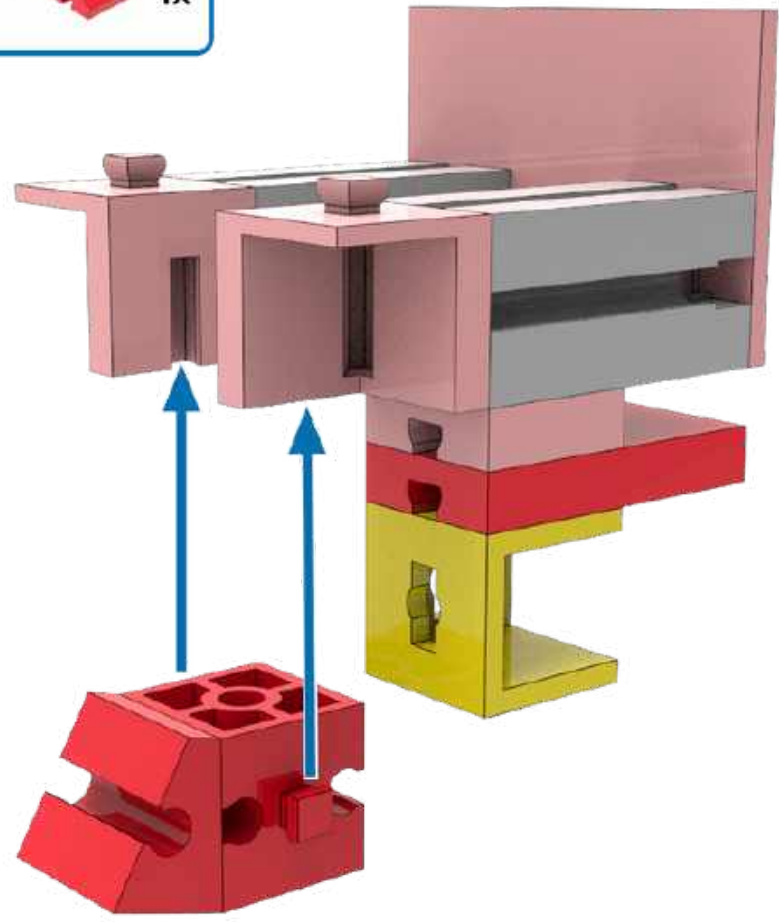

22  1x  1x  1x  30° 1x

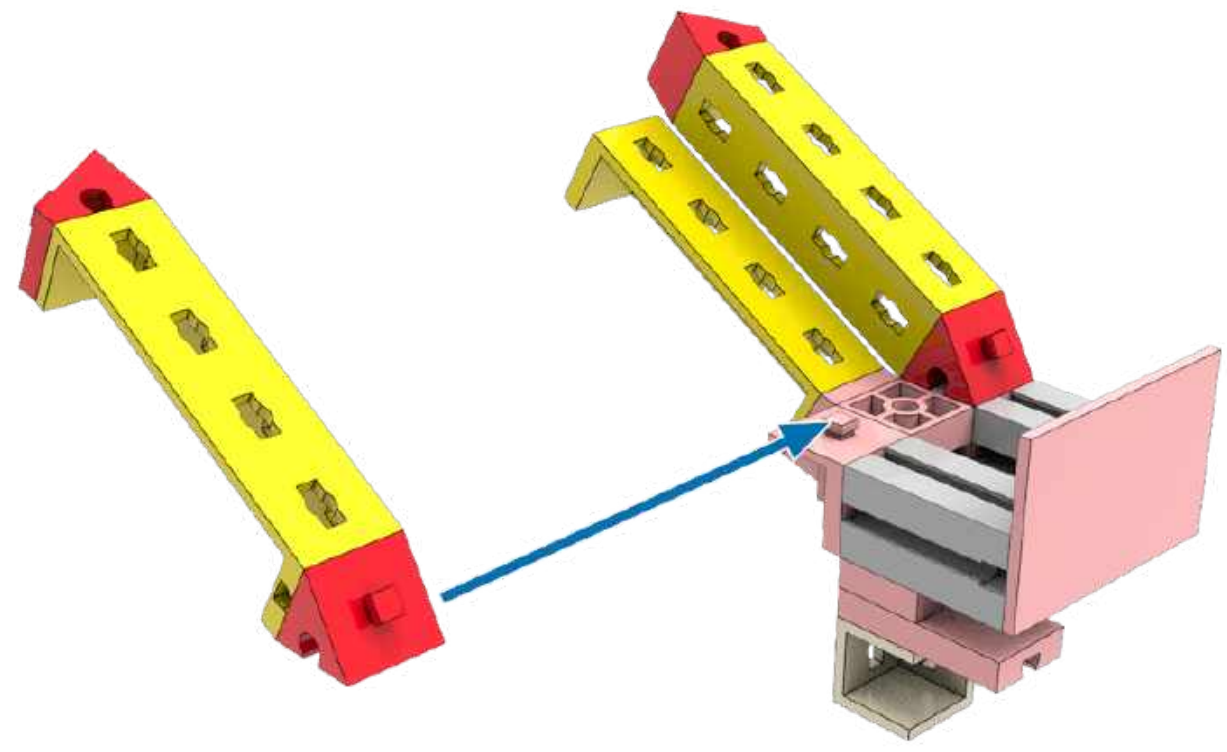

23 ^{60°} 2x ^{30°} 2x 3x



24  5x  6x

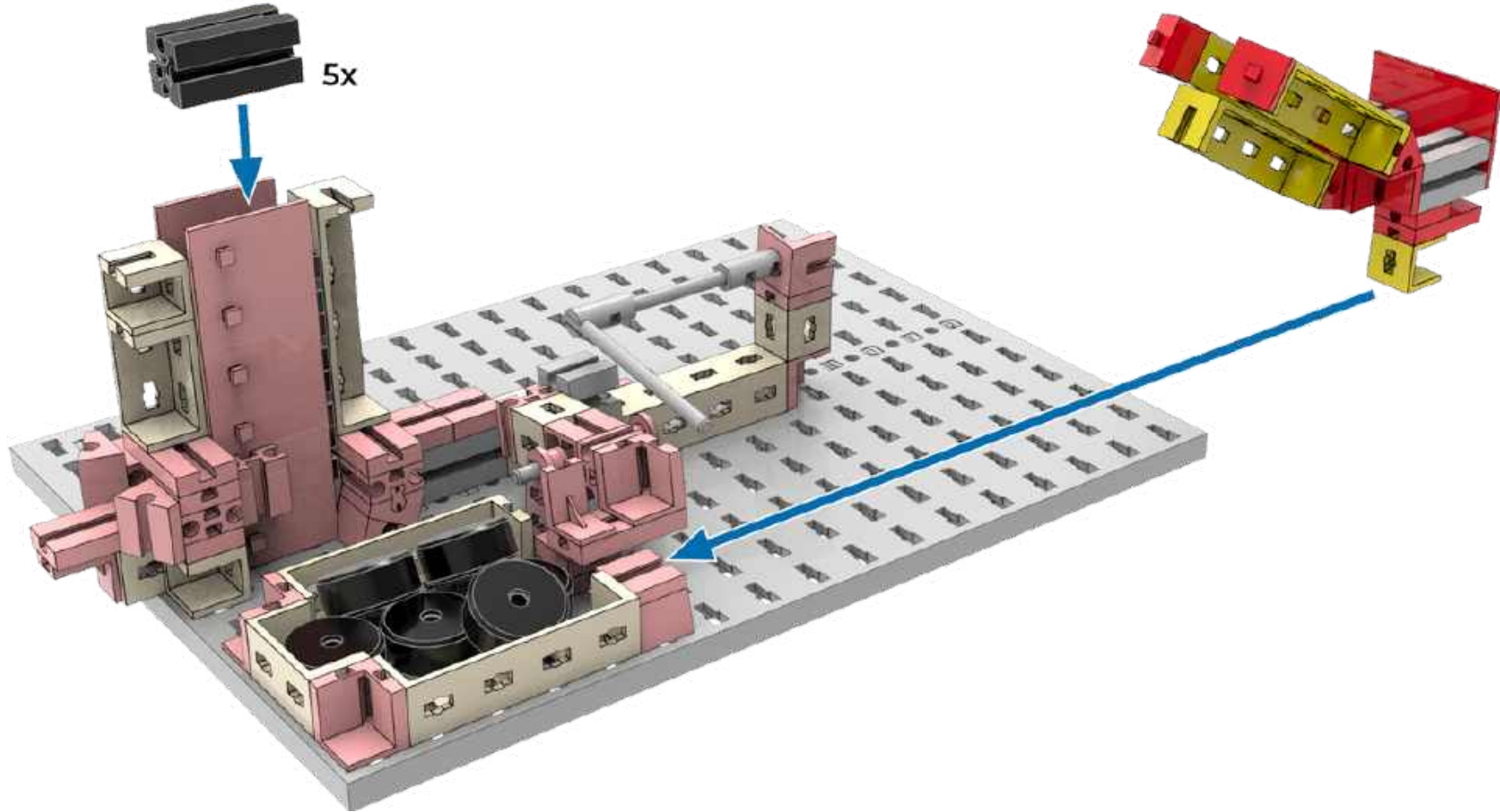

Aufzug



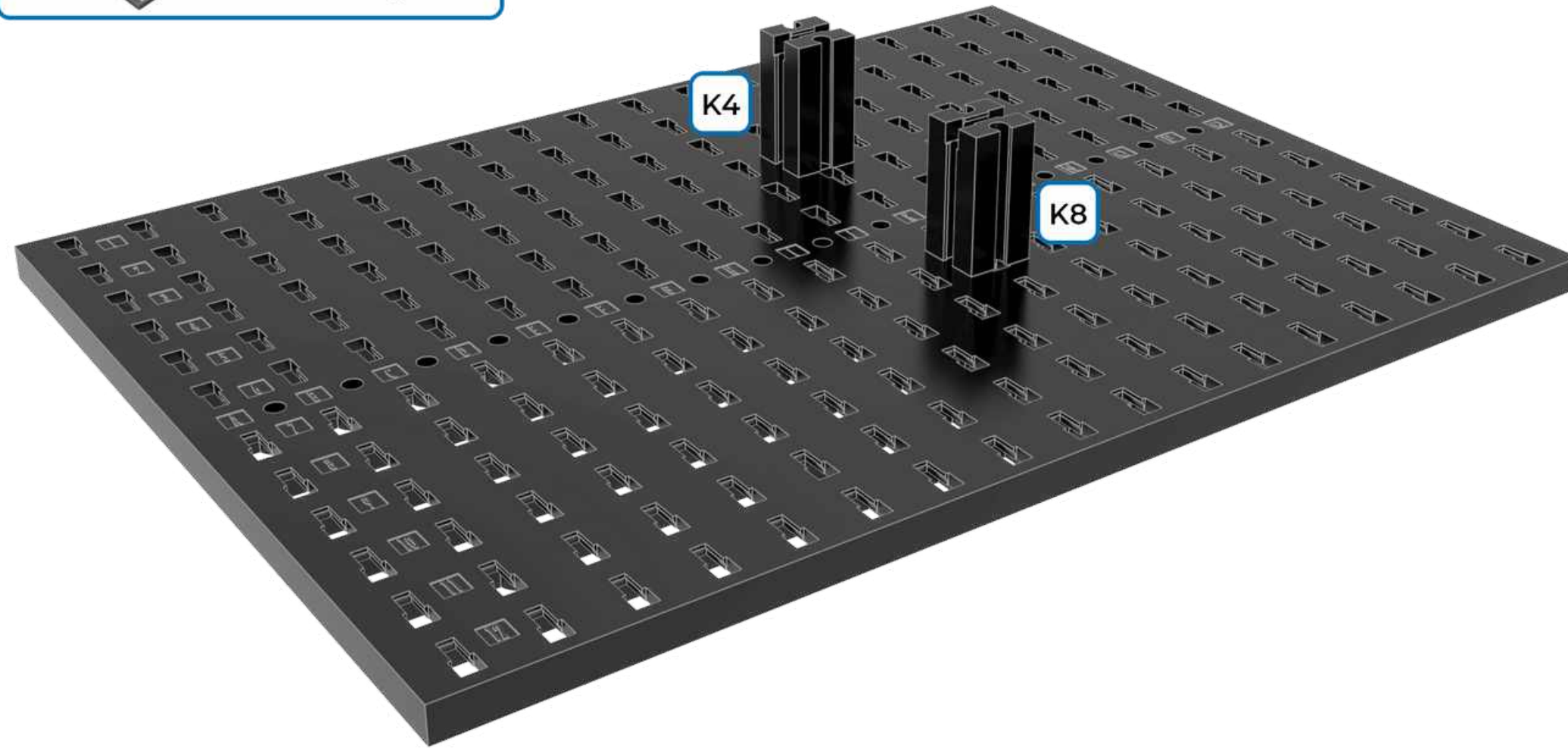
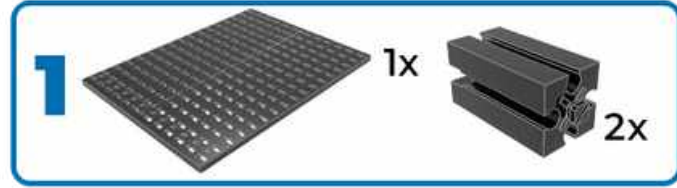

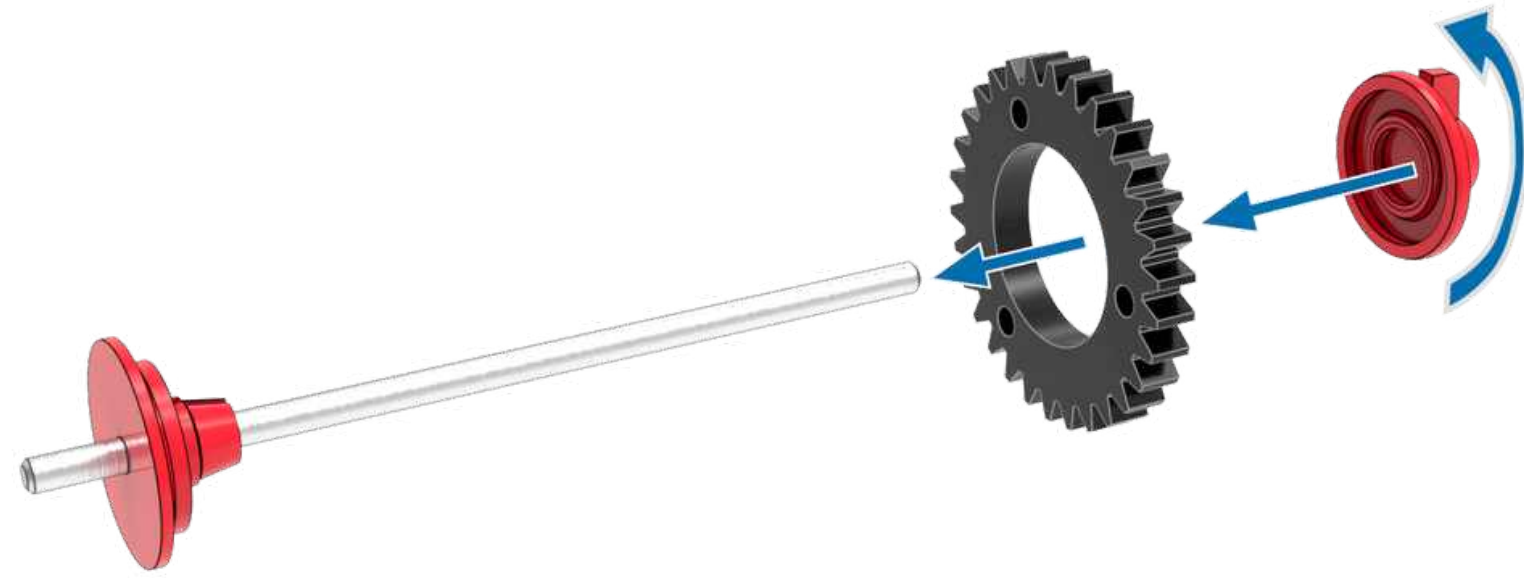
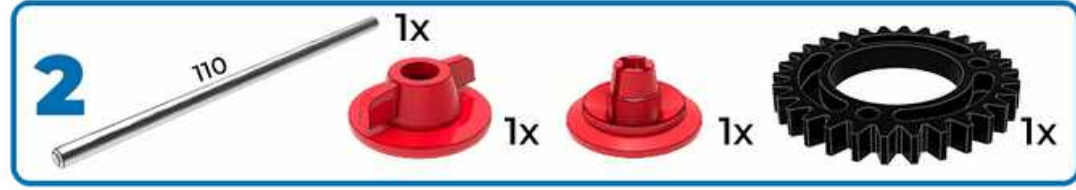

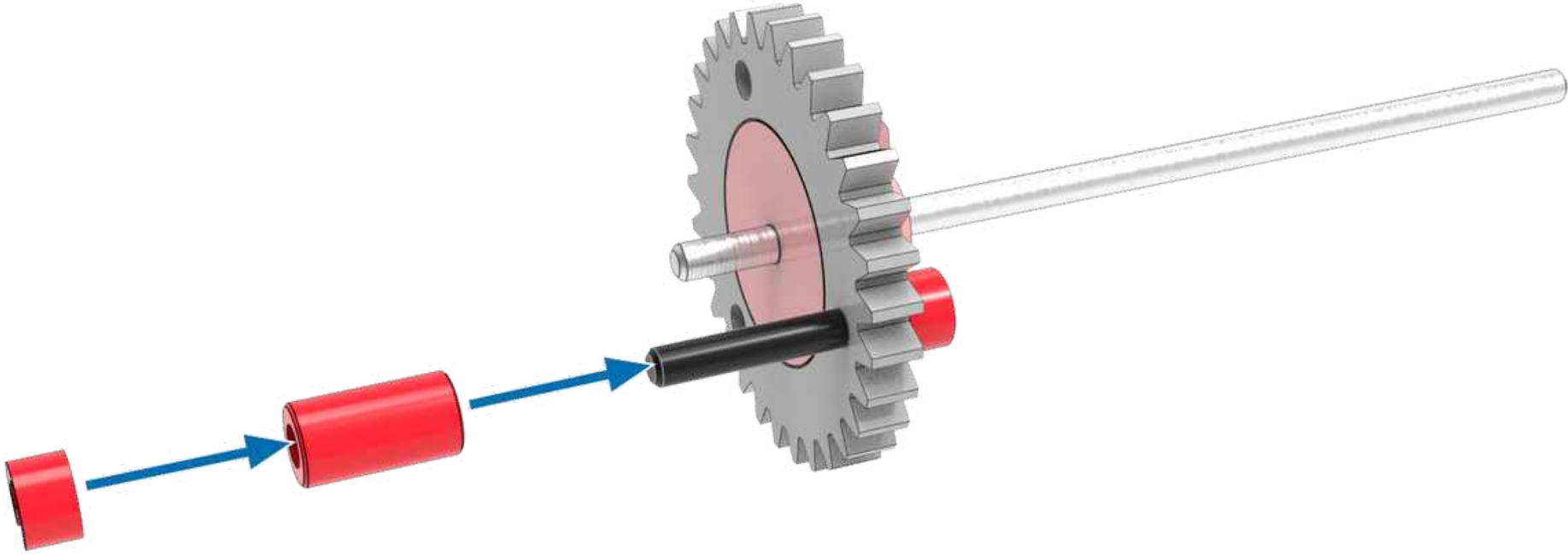

3 30 1x
2x 1x

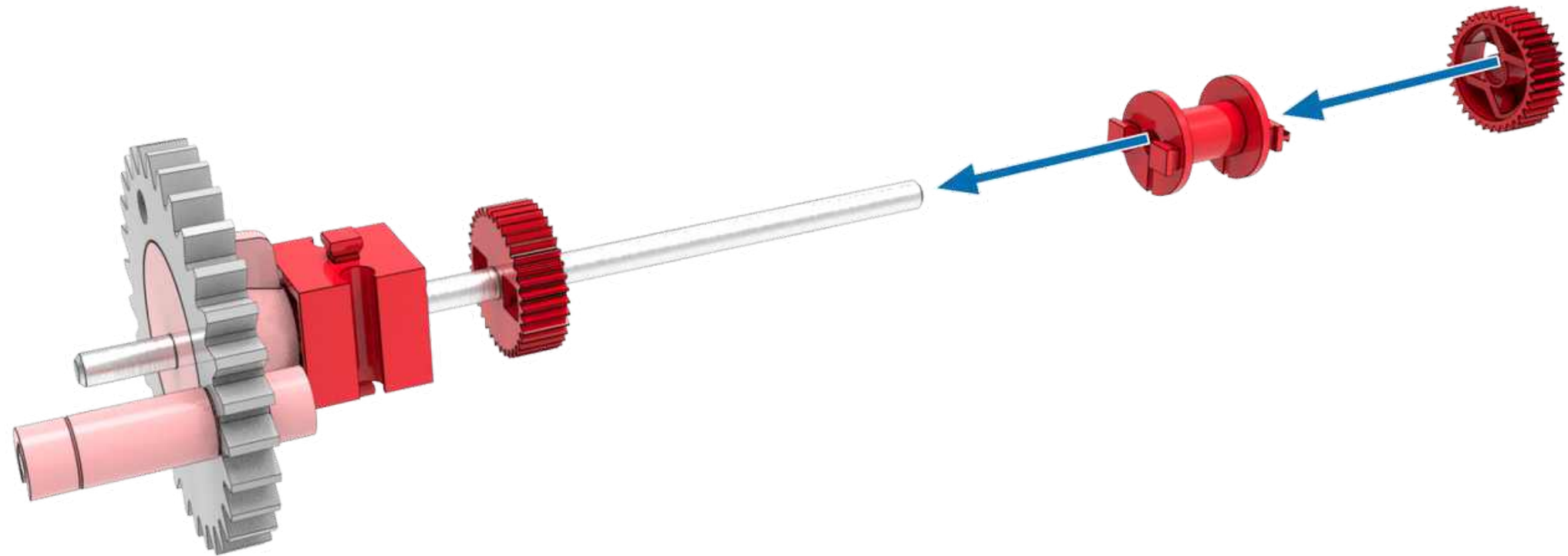

4  1x  1x  2x



5  1x

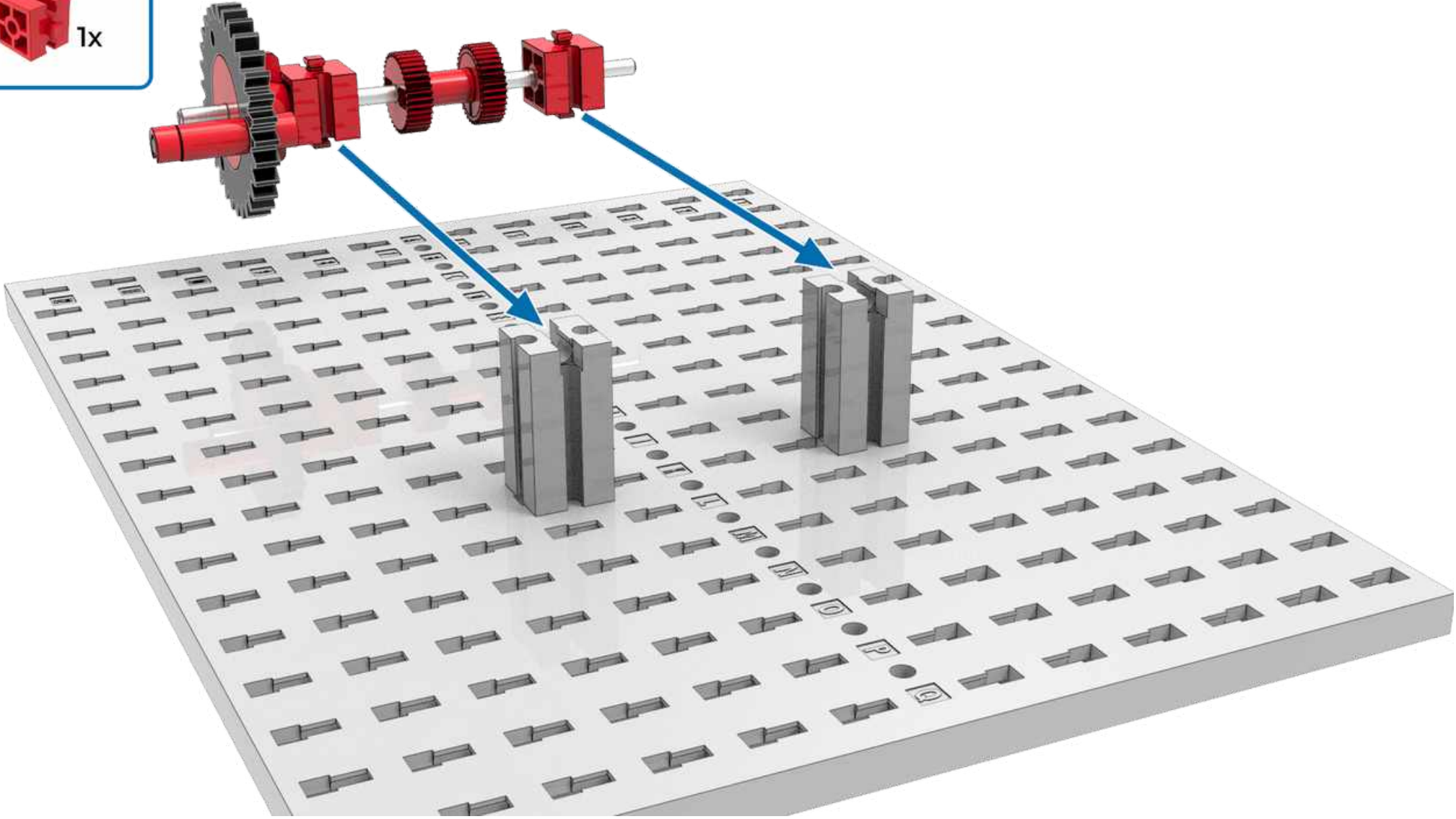

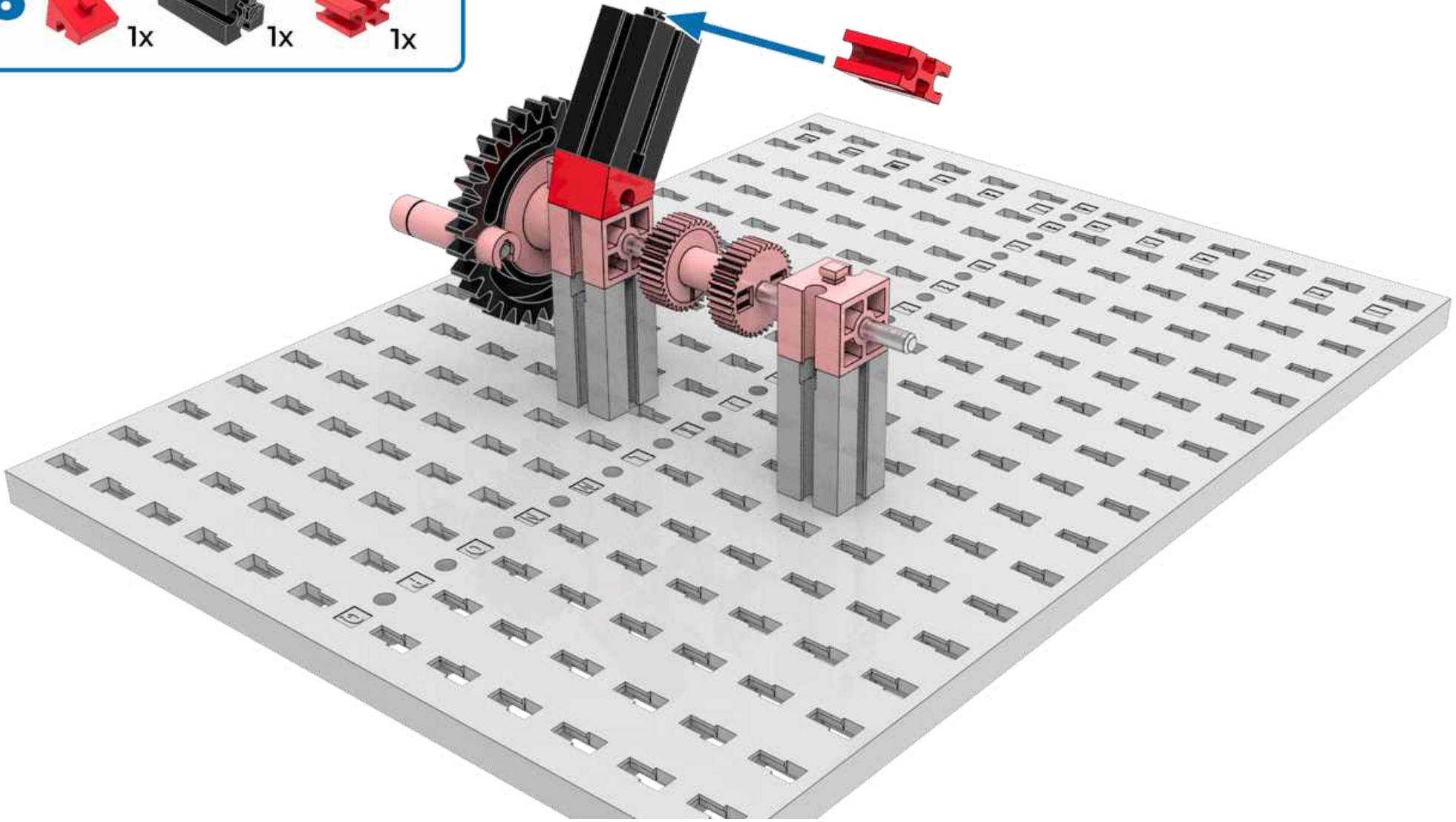

6 30° 1x 1x 1x

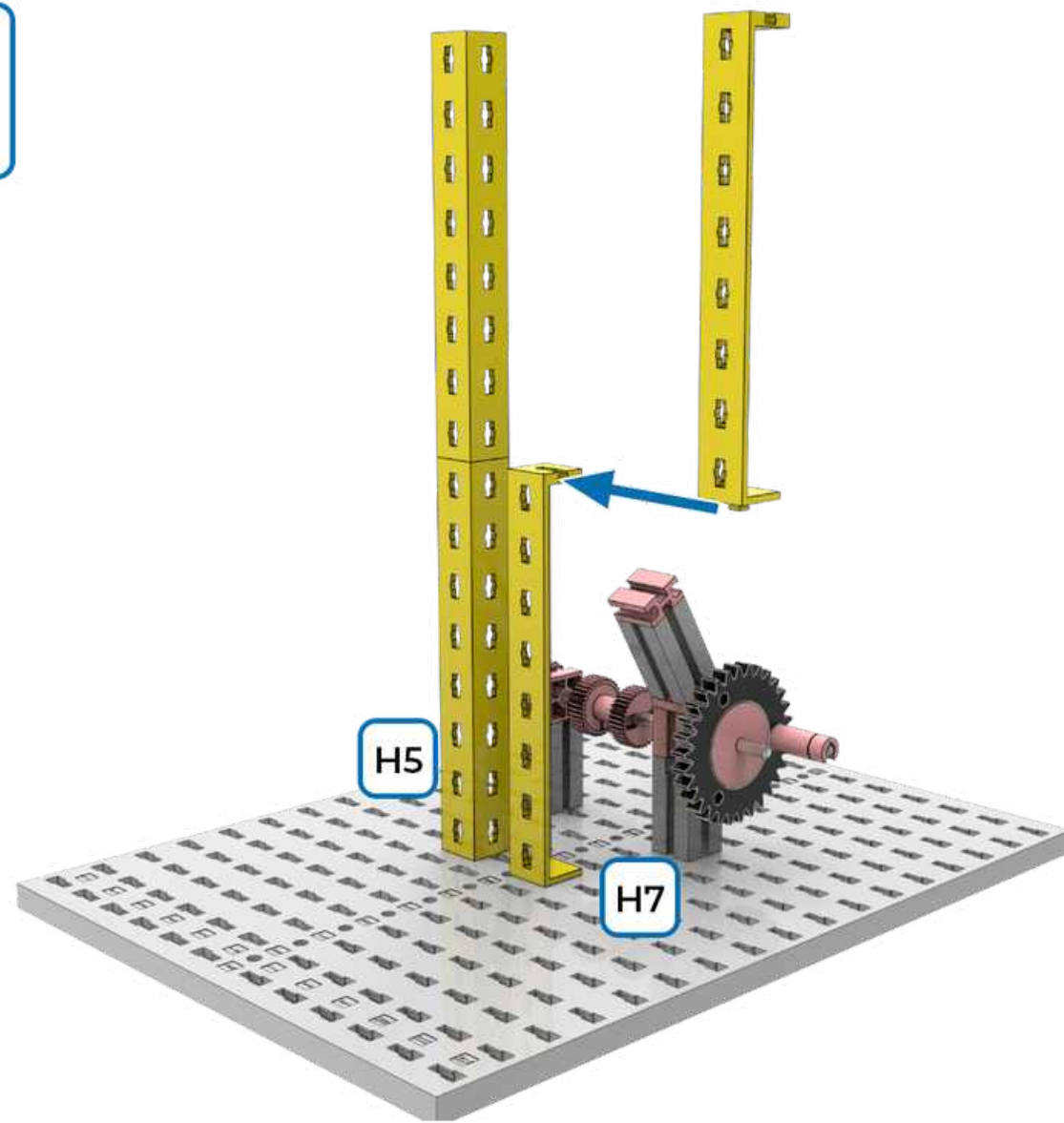

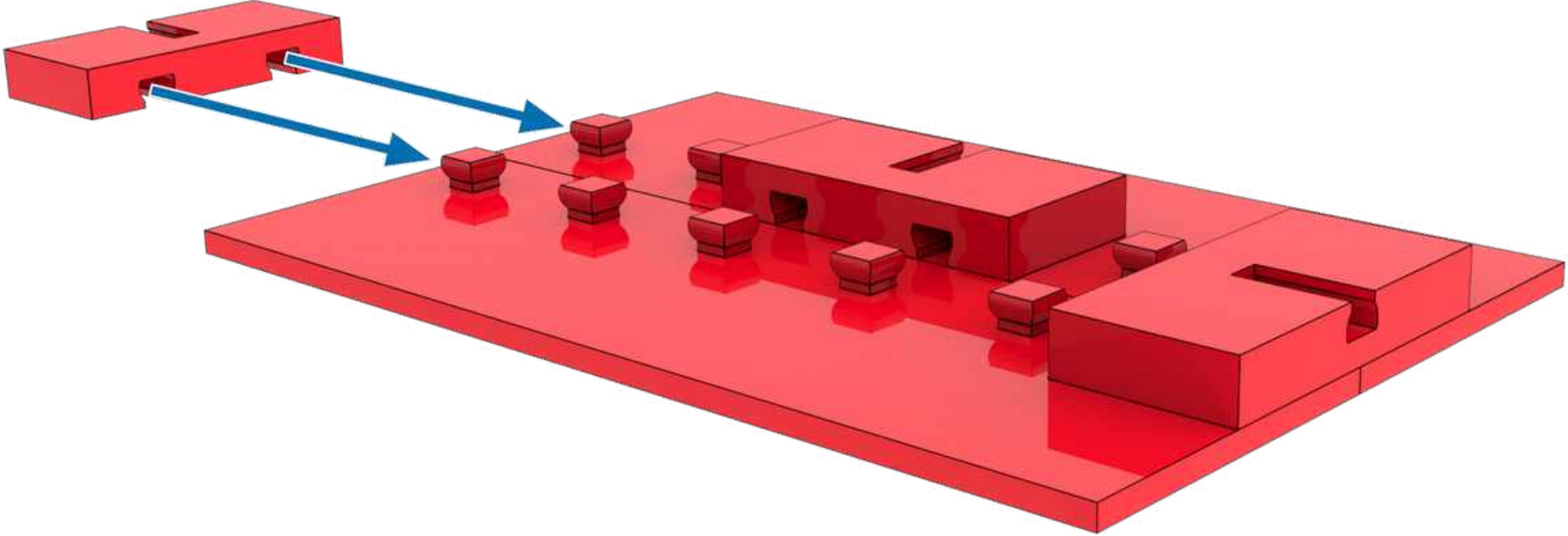
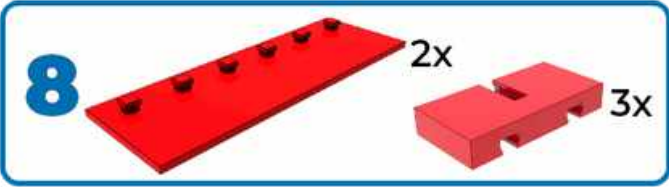





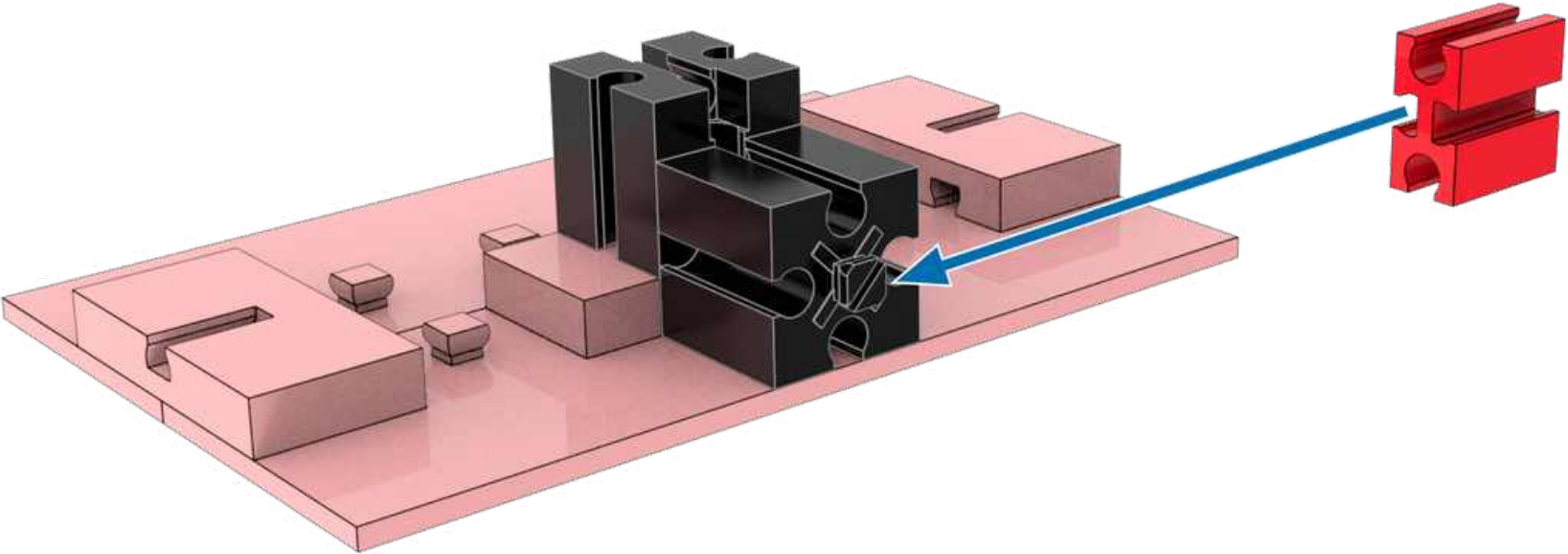





9  1x  1x  1x

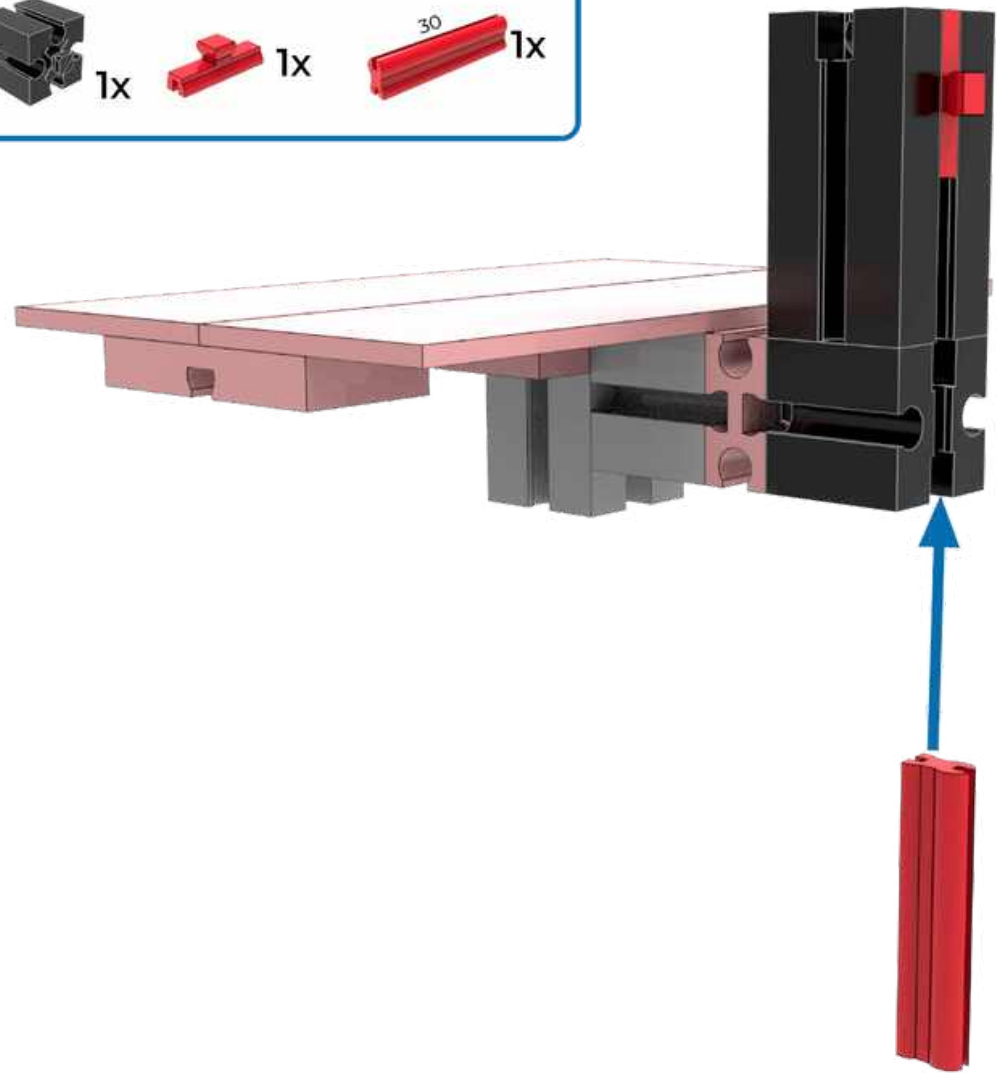

10  1x  1x  1x  1x



11  1x  1x  4x  2x

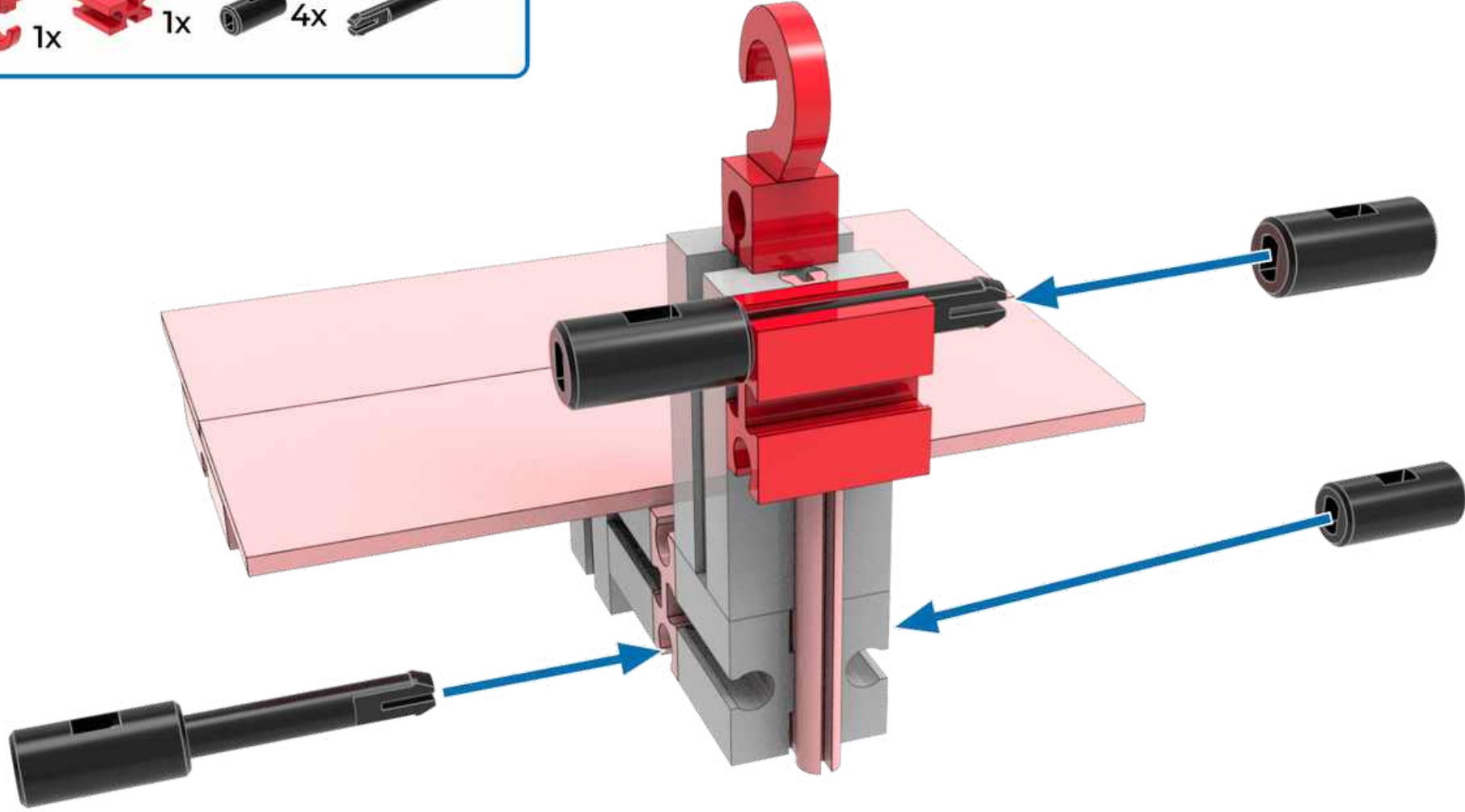

12  1x

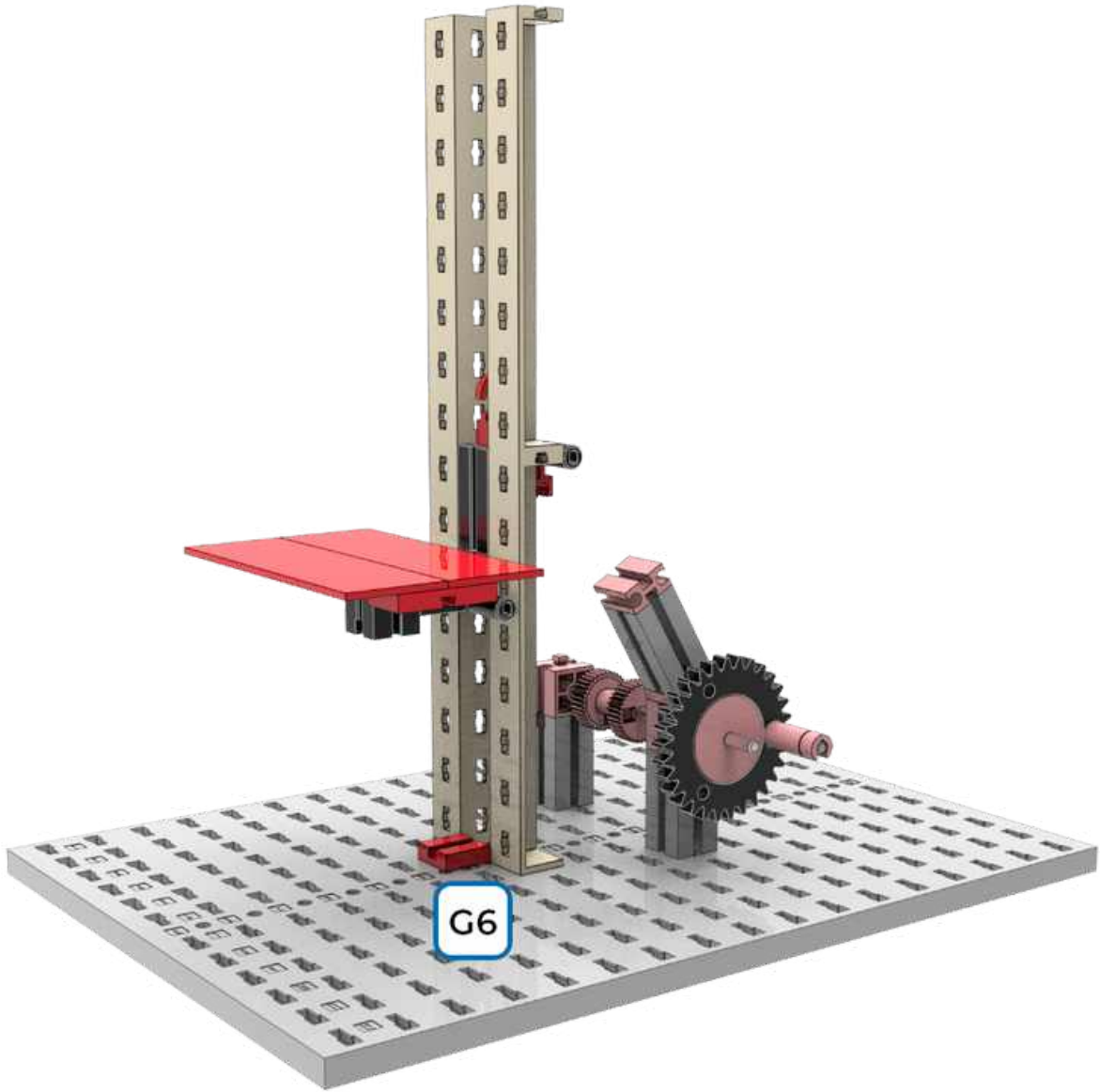

13 40 1x 1x 2x



14



1x 40 1x 2x

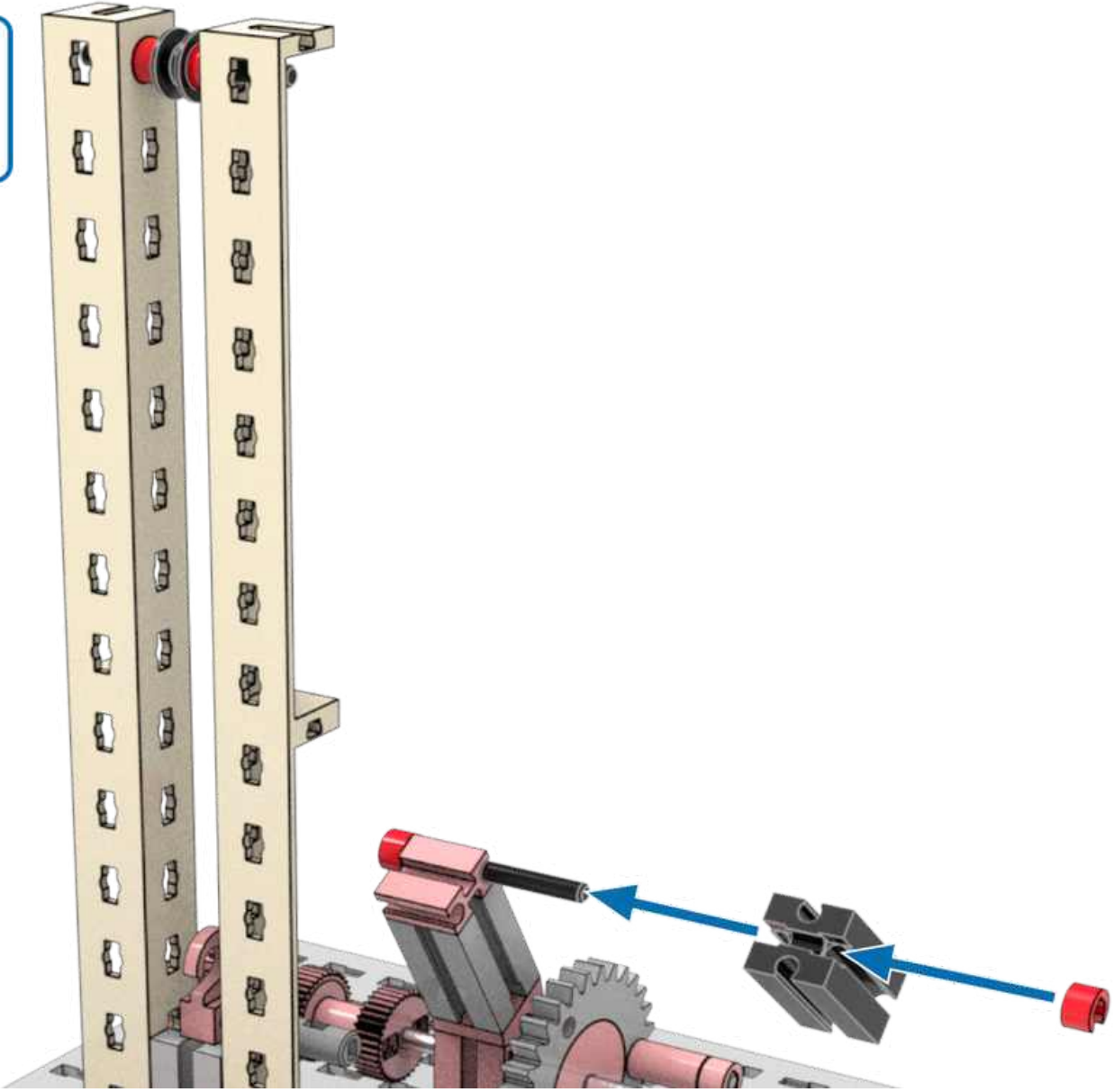



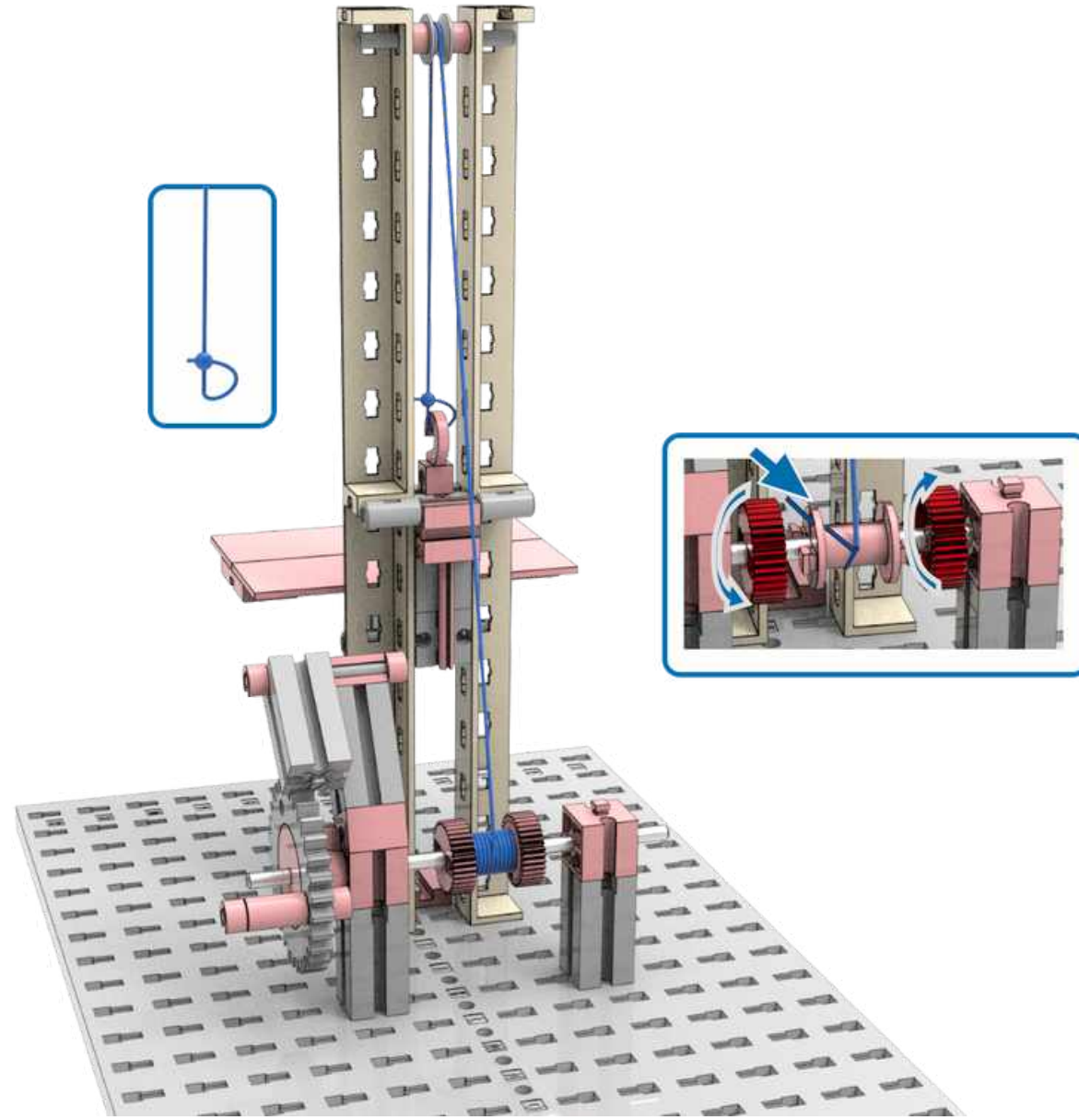

15  1x

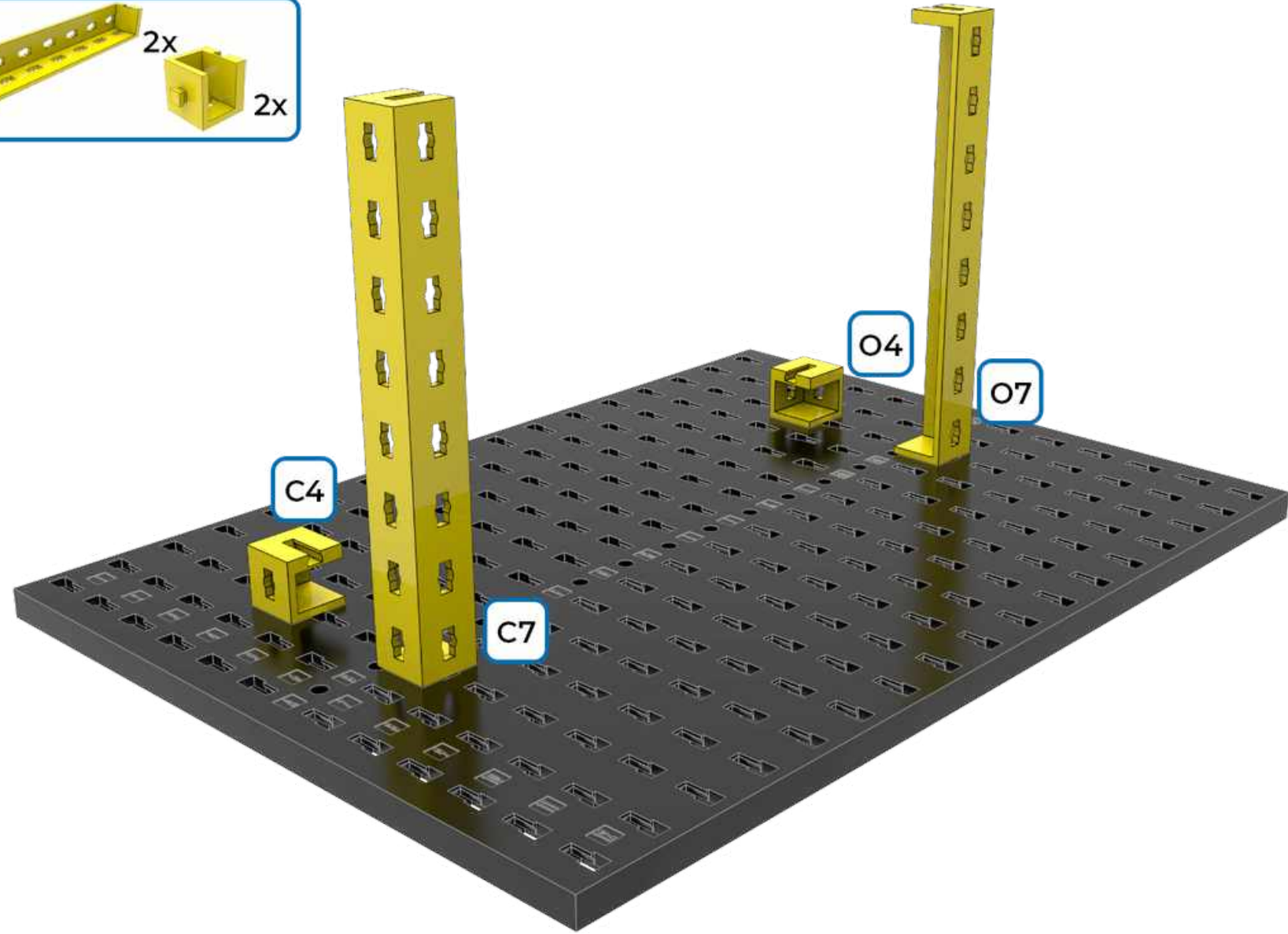
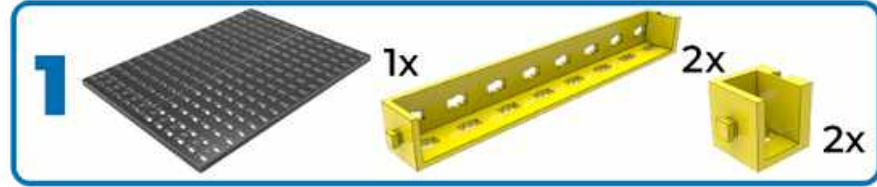

Kniegelenk



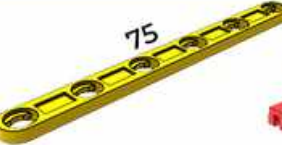



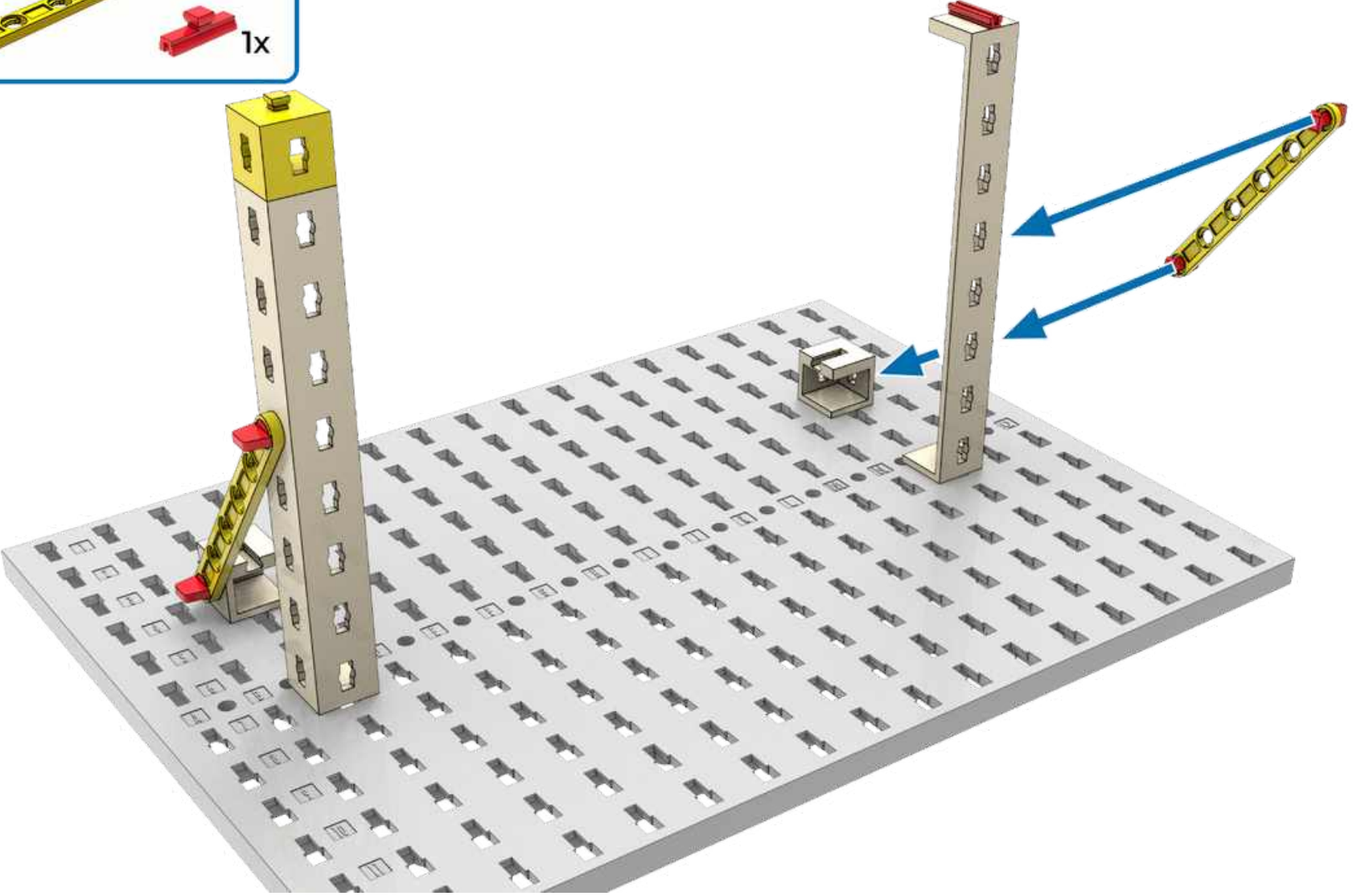

2  1x  4x  2x  1x

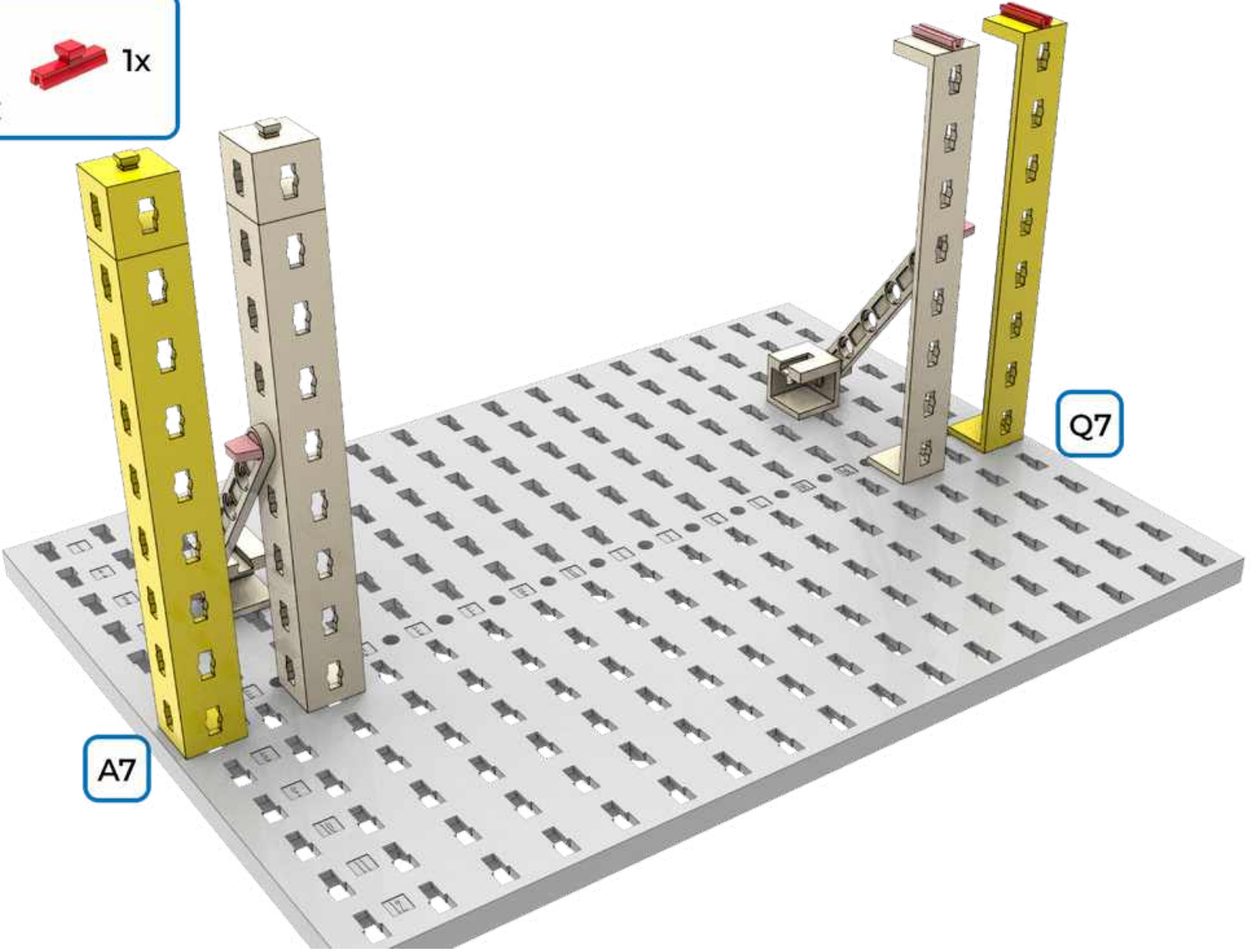



3 2x 1x 1x



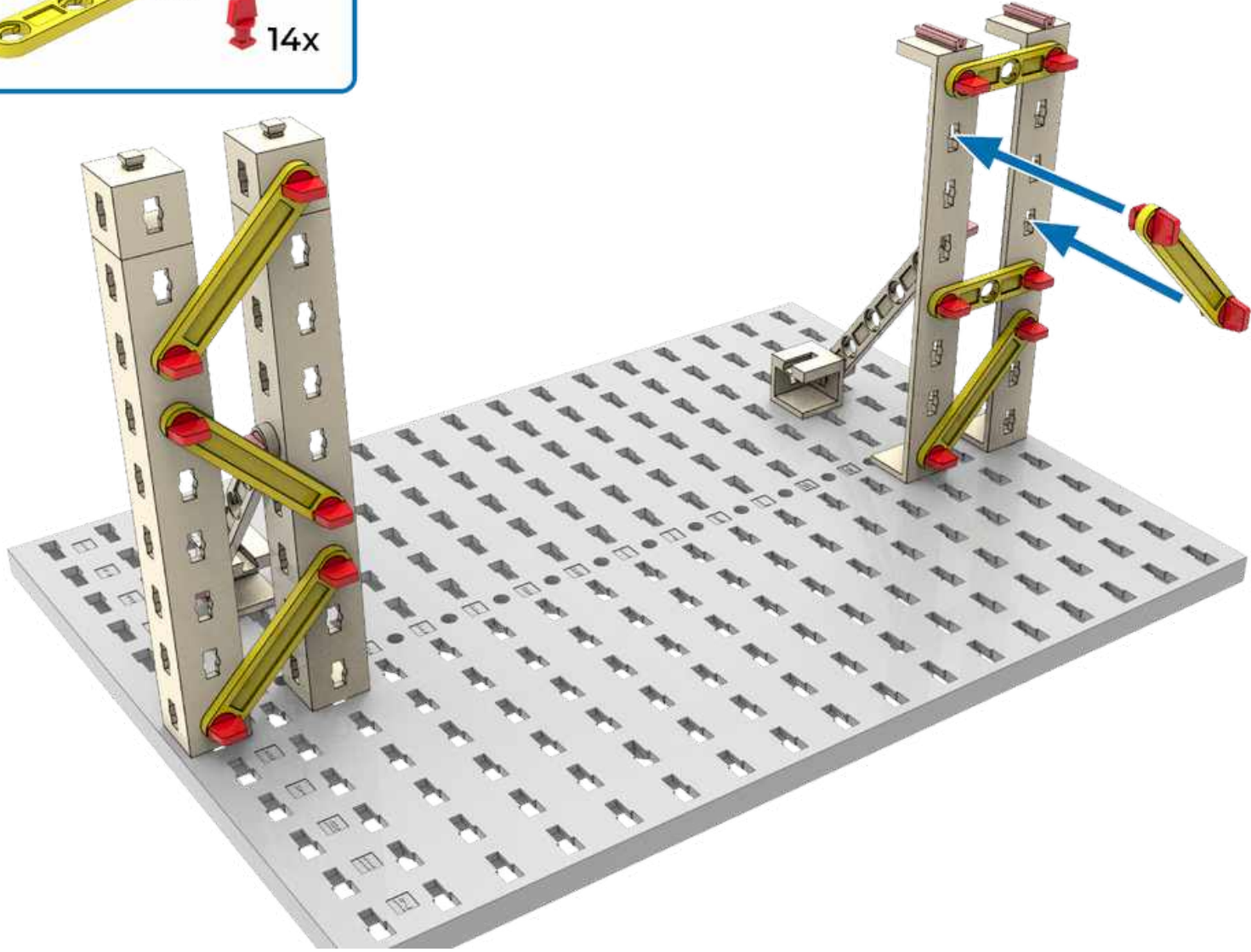

4  5x  2x  14x



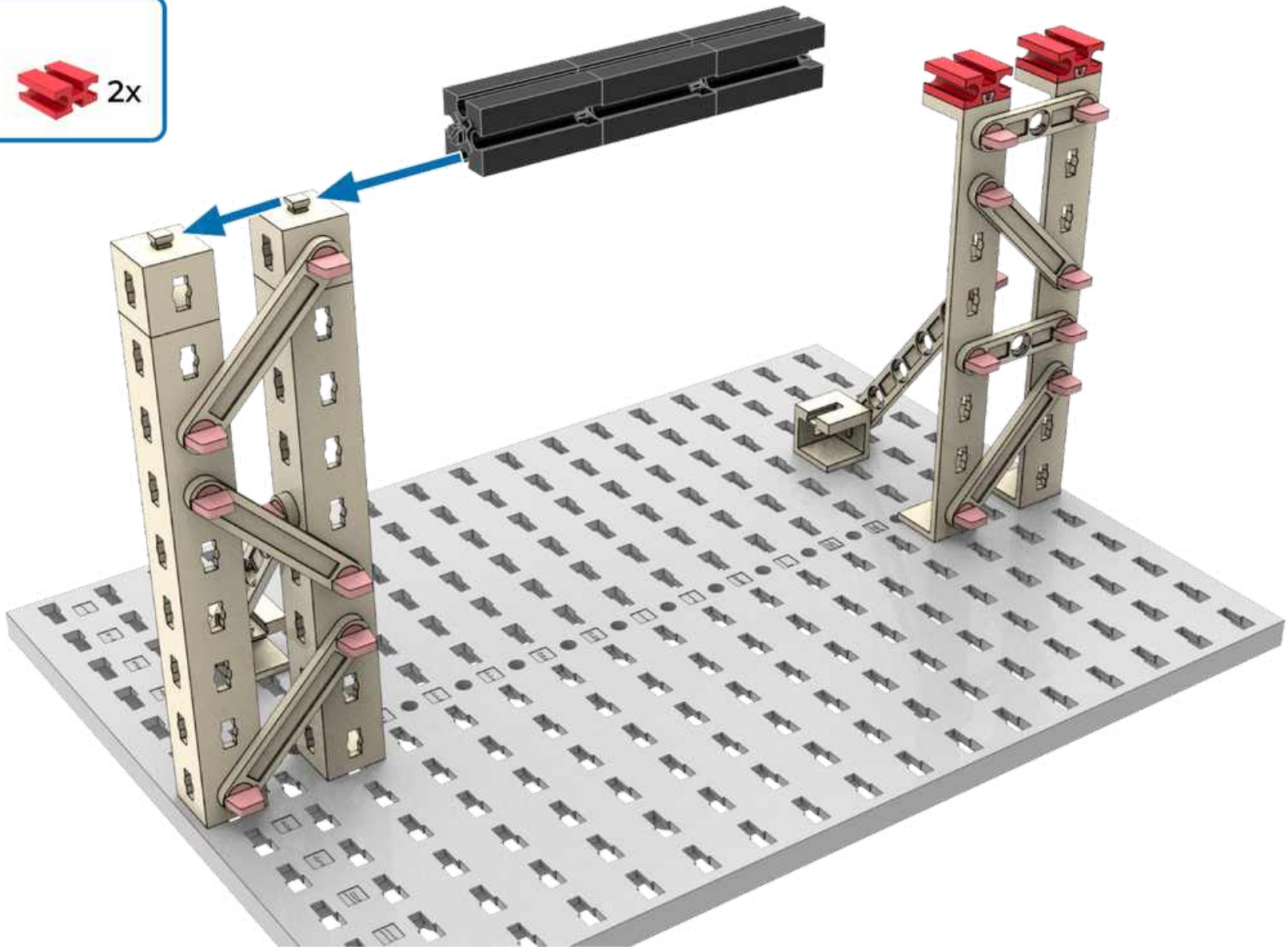

5  3x  2x

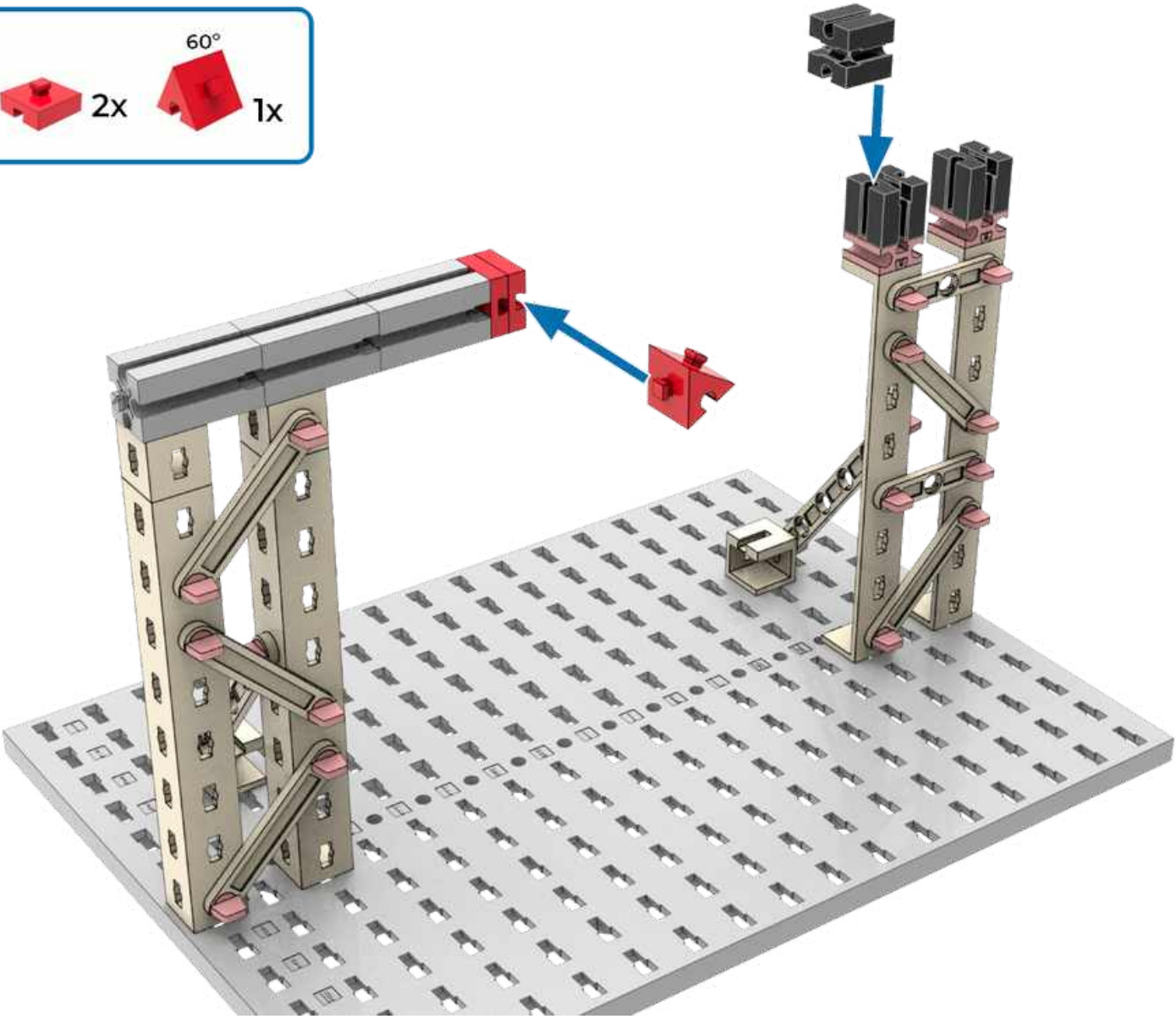

6  3x  2x  1x



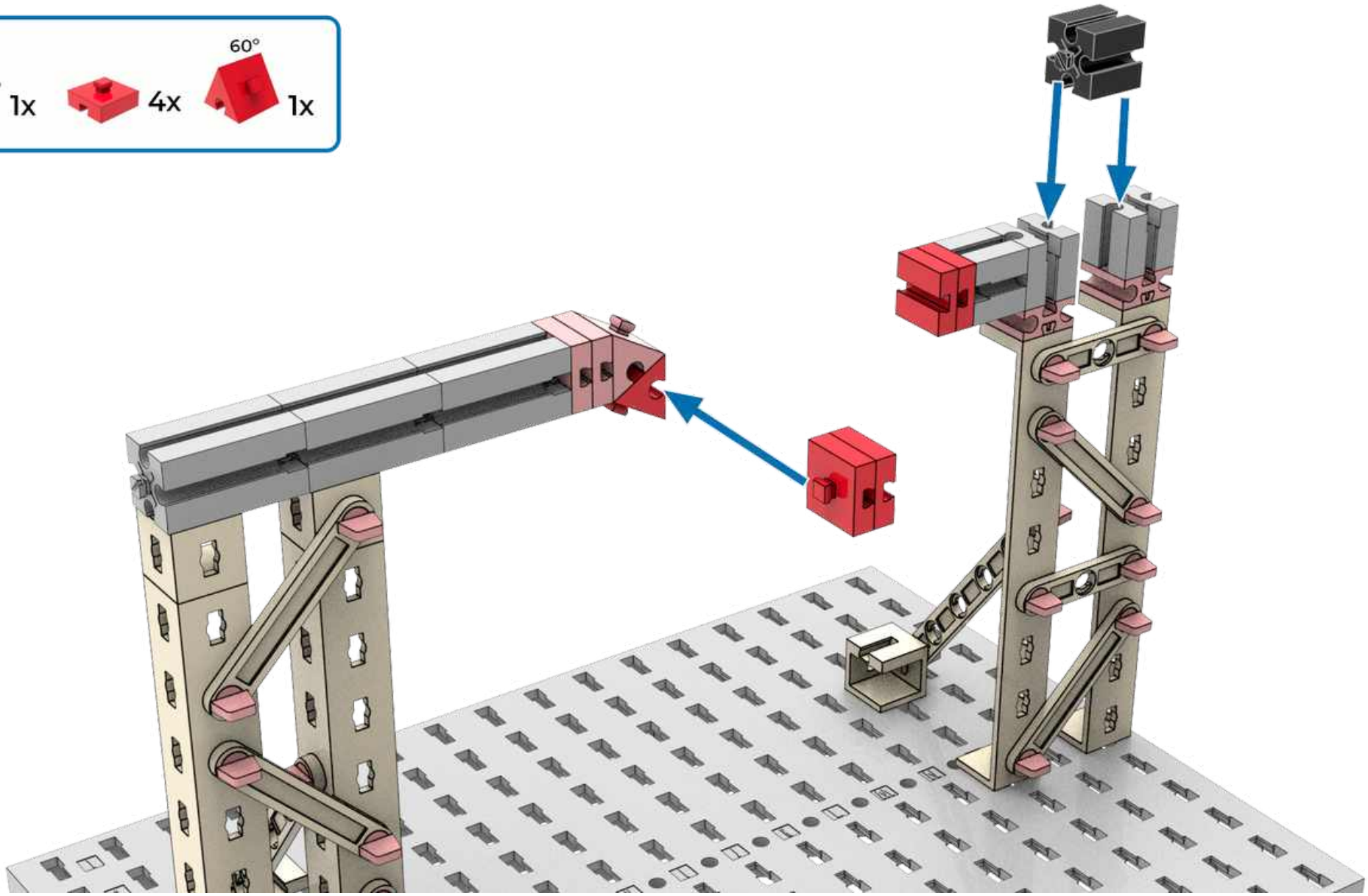

7  1x  4x  1x



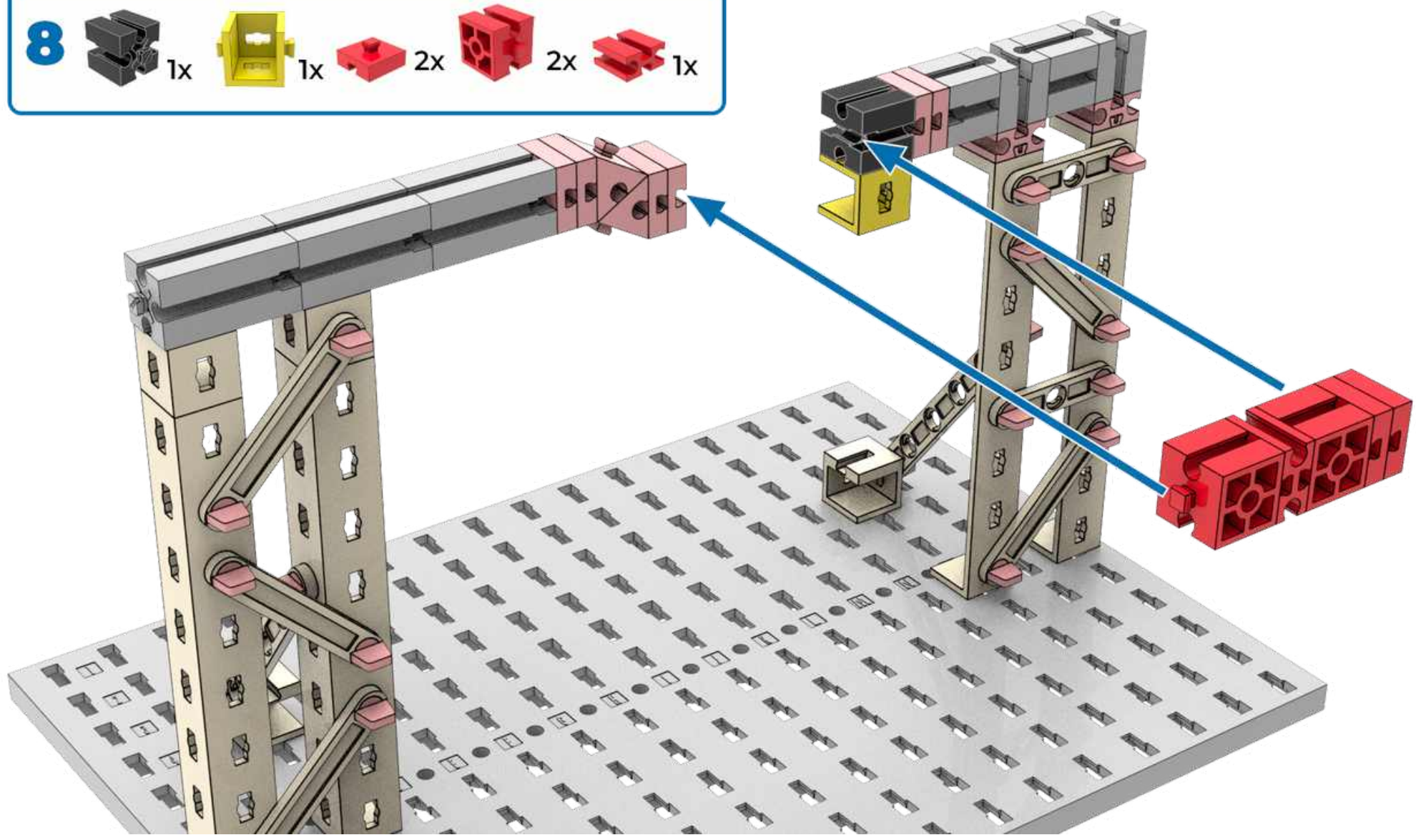

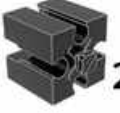
- 8
- 1x Black Technic Pin
 - 1x Yellow Technic Bracket
 - 2x Red Technic Pin
 - 2x Red Technic 1x3 Technic Beam
 - 1x Red Technic 1x2 Technic Beam

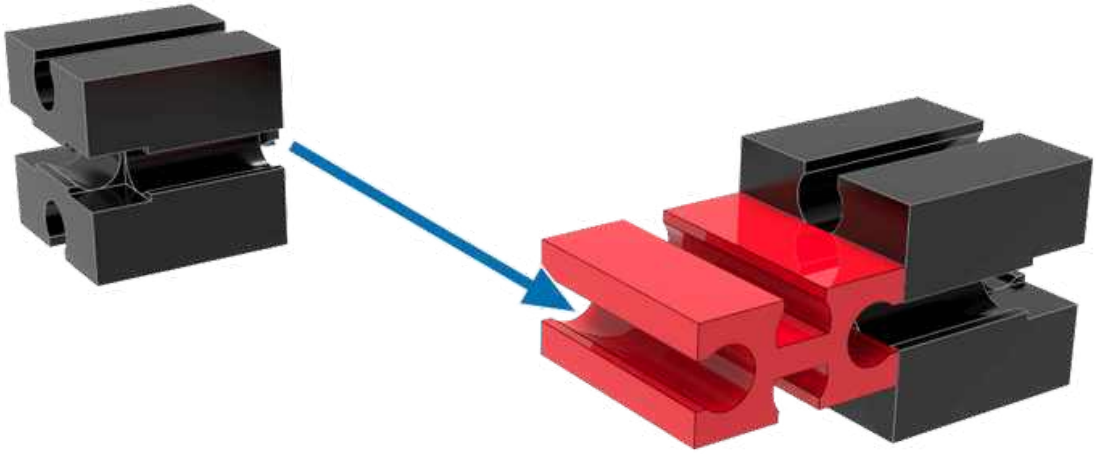

9  2x  1x





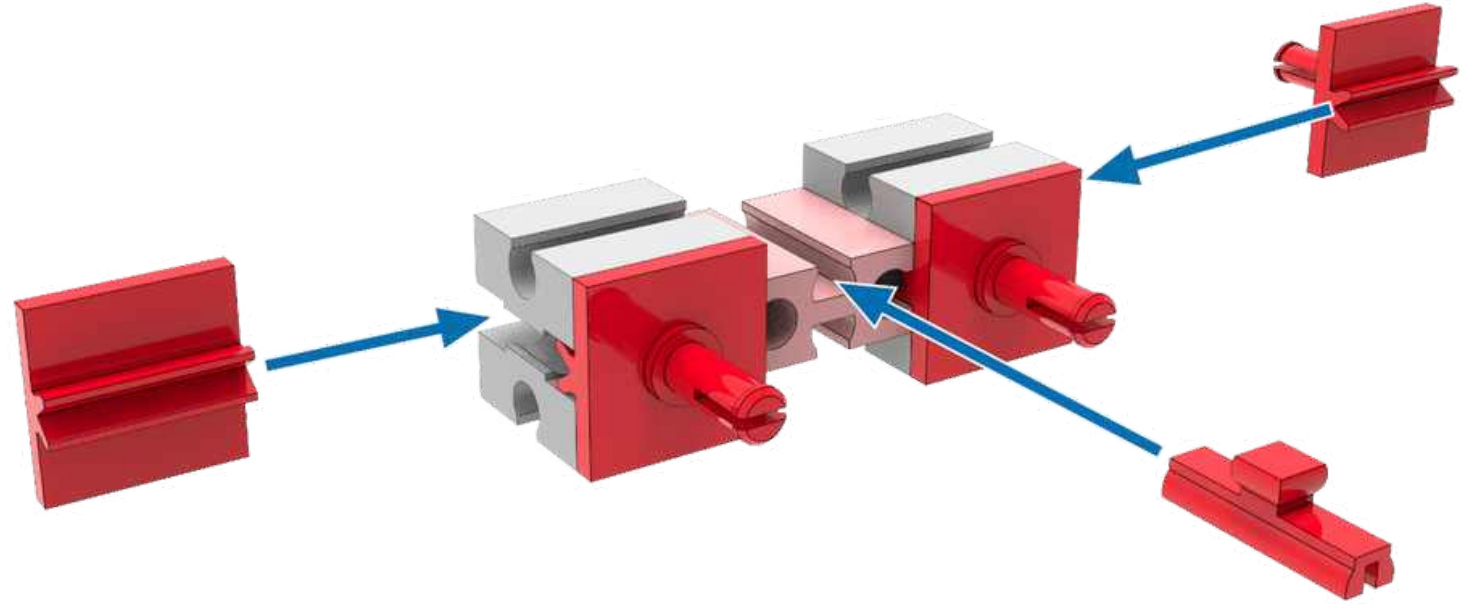

10  4x  1x

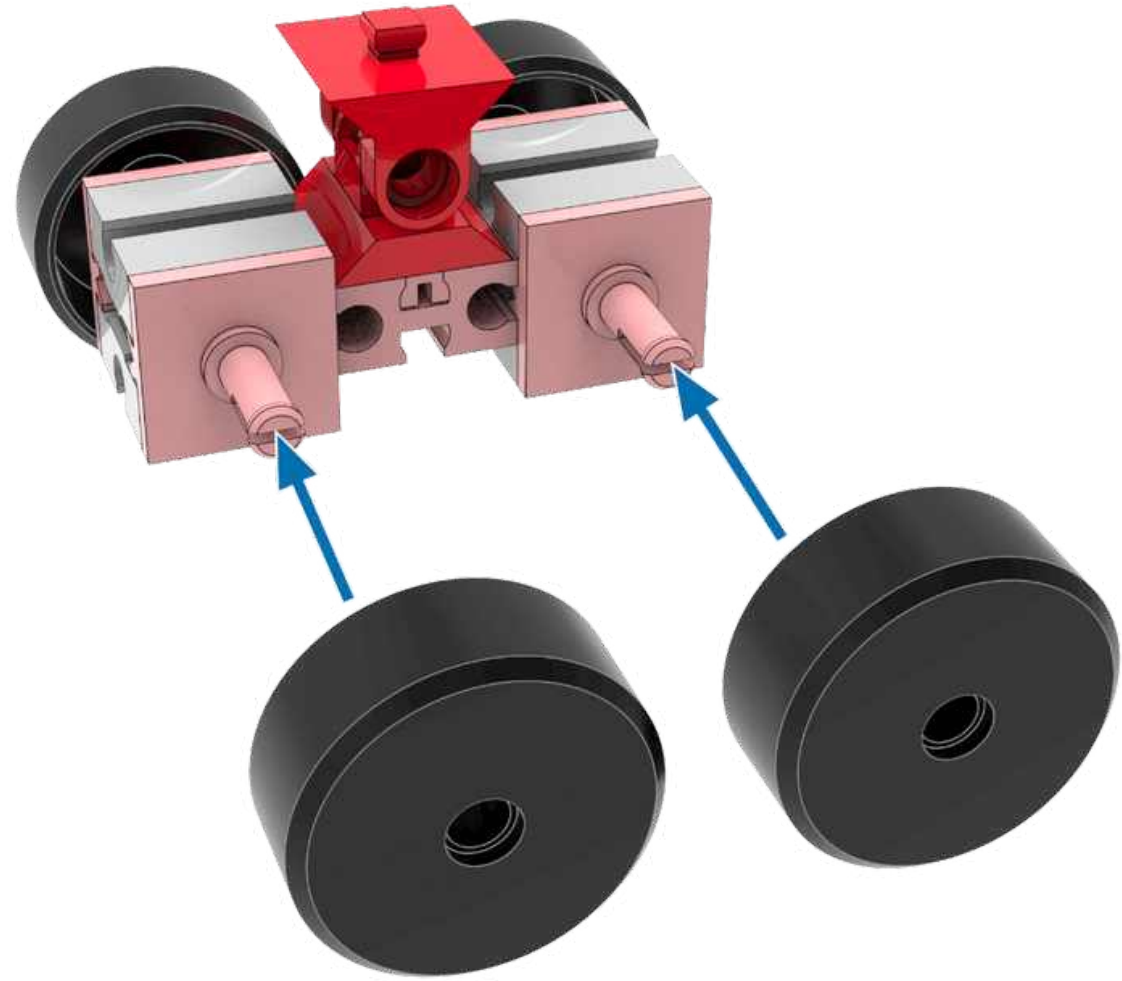
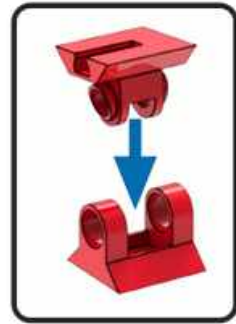





11  1x  1x  4x

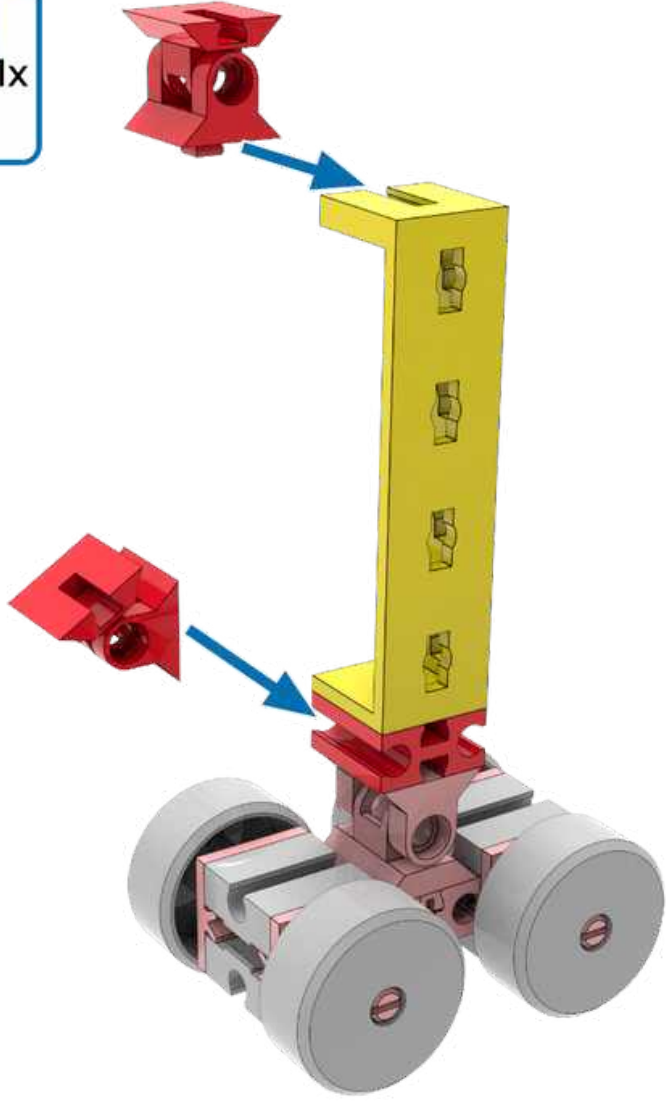
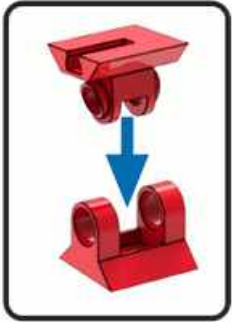





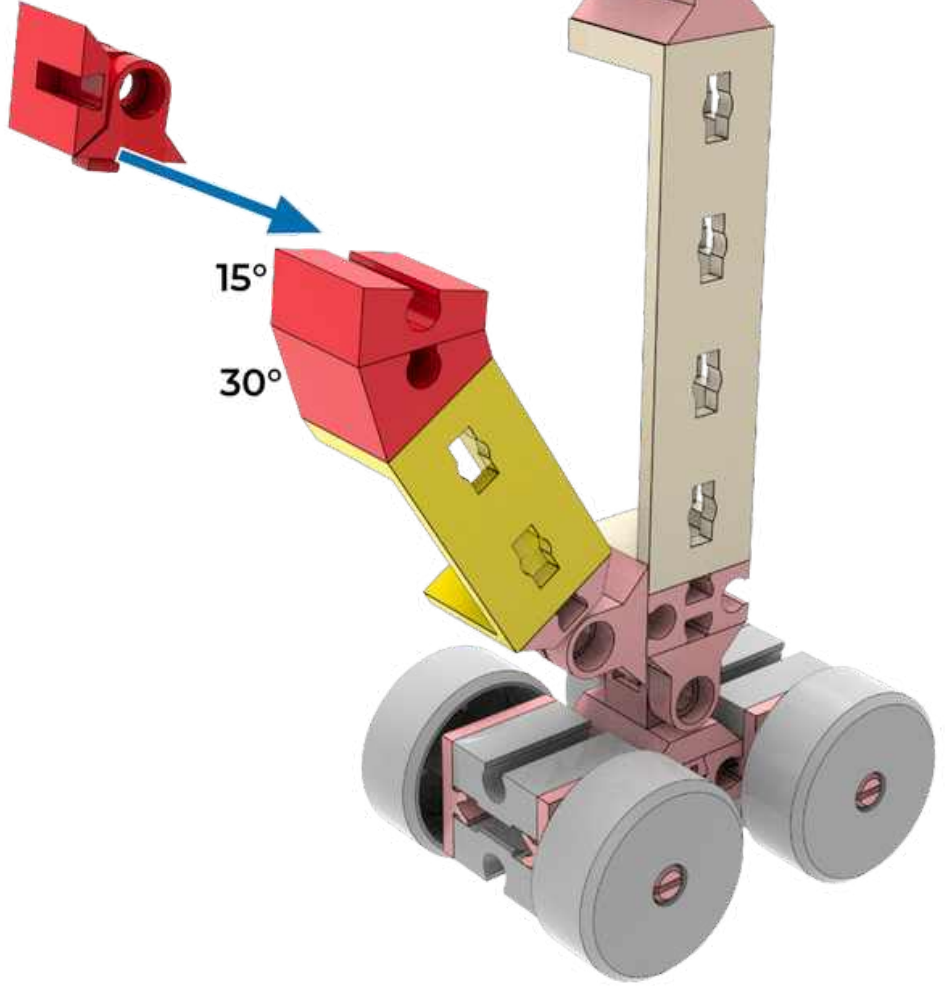
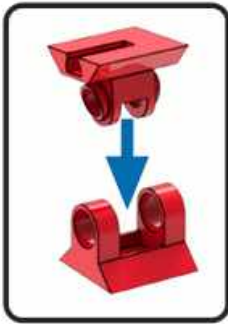

12  2x  2x  1x  1x



- 13**  1x  1x  1x  1x  1x



- 14**  1x  1x  30° 1x  15° 1x  1x  1x

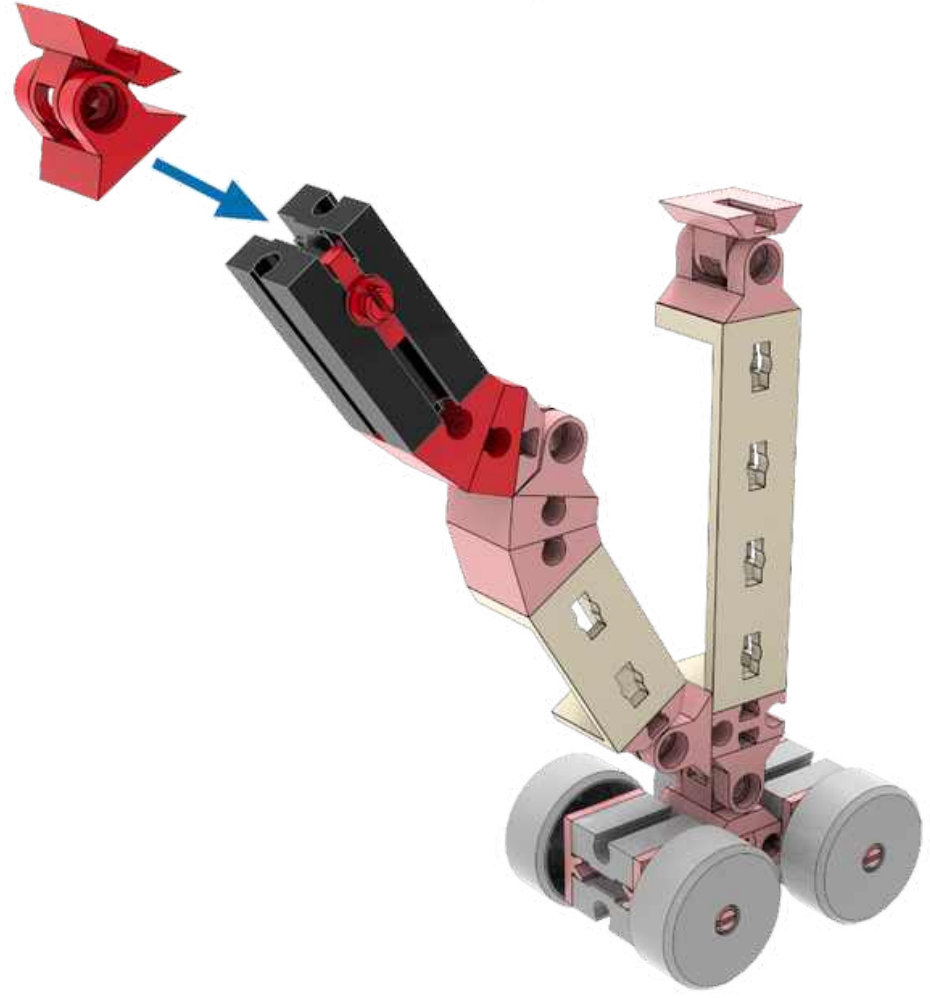
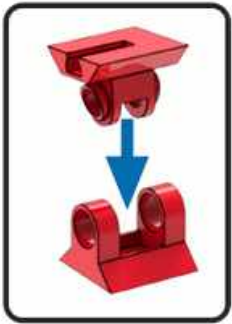



15

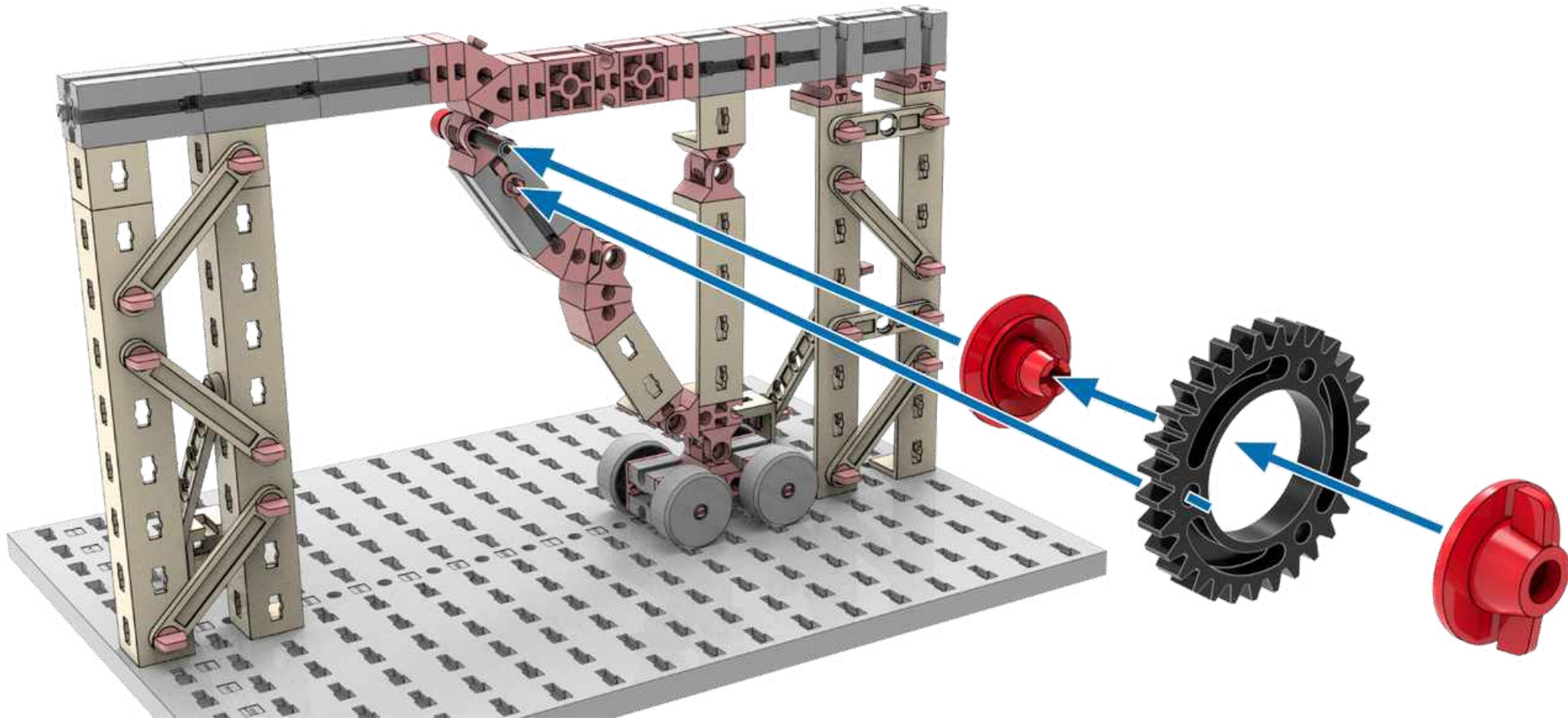

16 40 1x 1x 1x 1x



17  1x  1x  1x

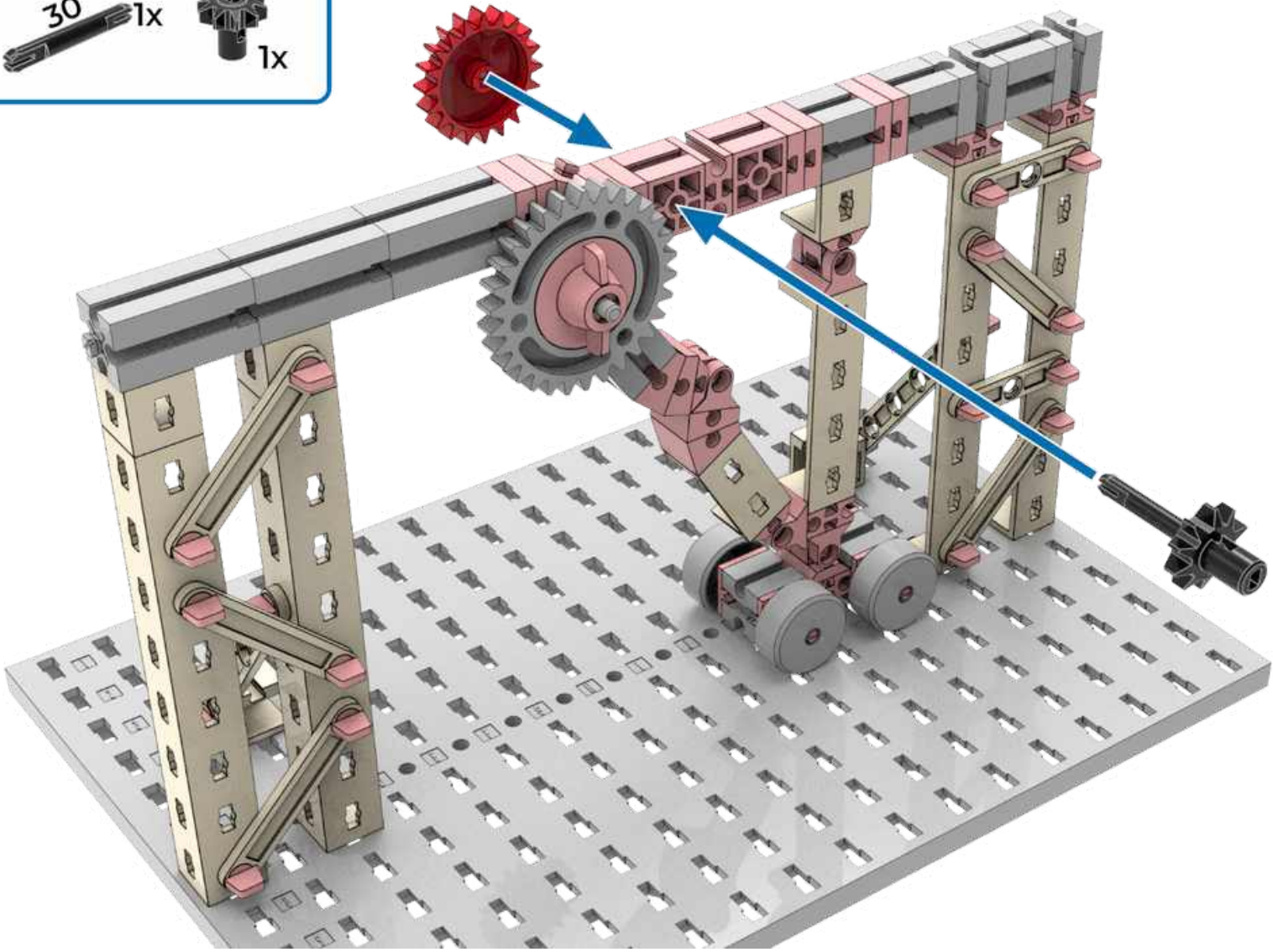

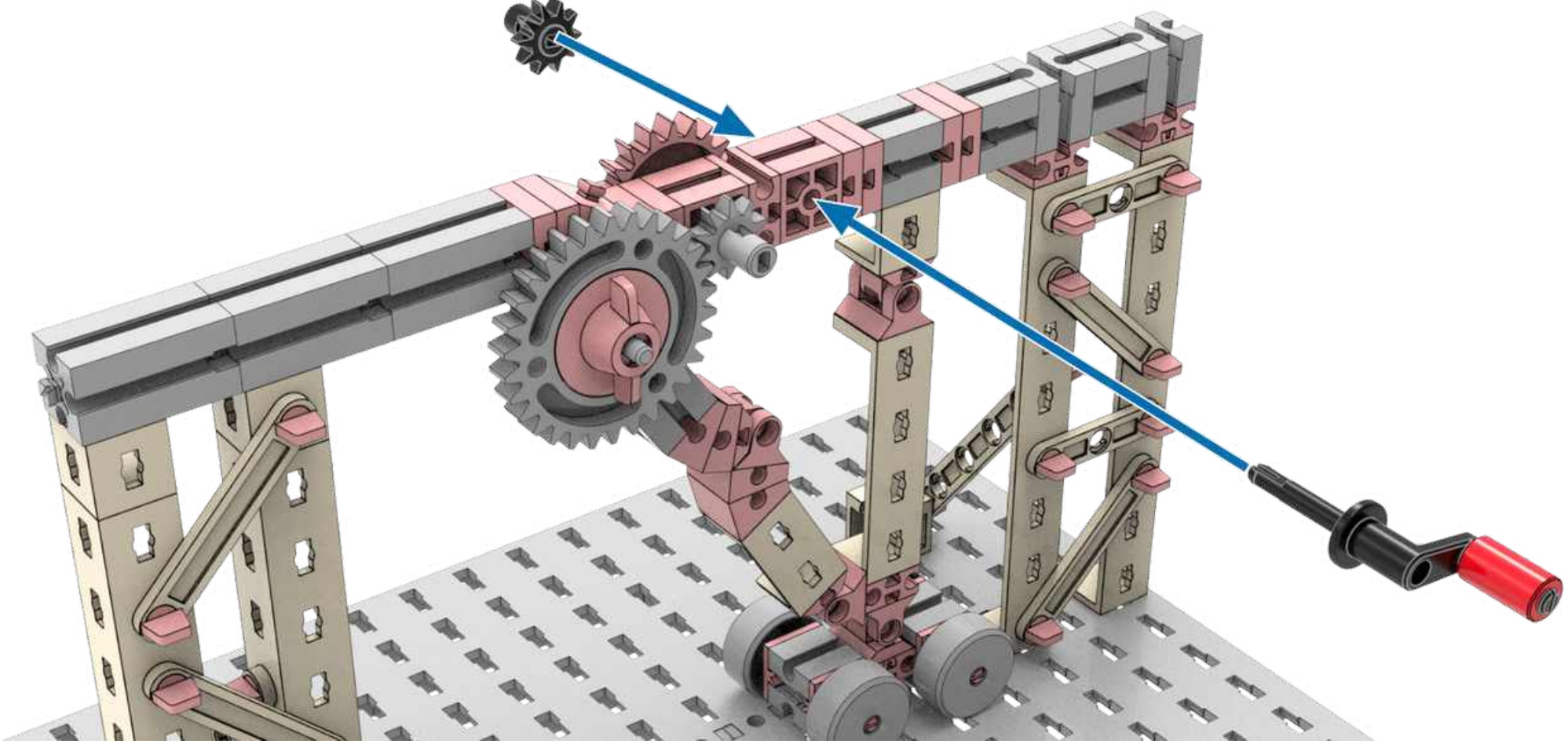

18  1x  1x  1x  1x



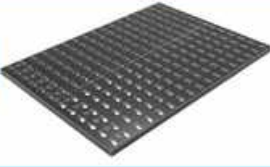

Scheibenwischer gegenläufig



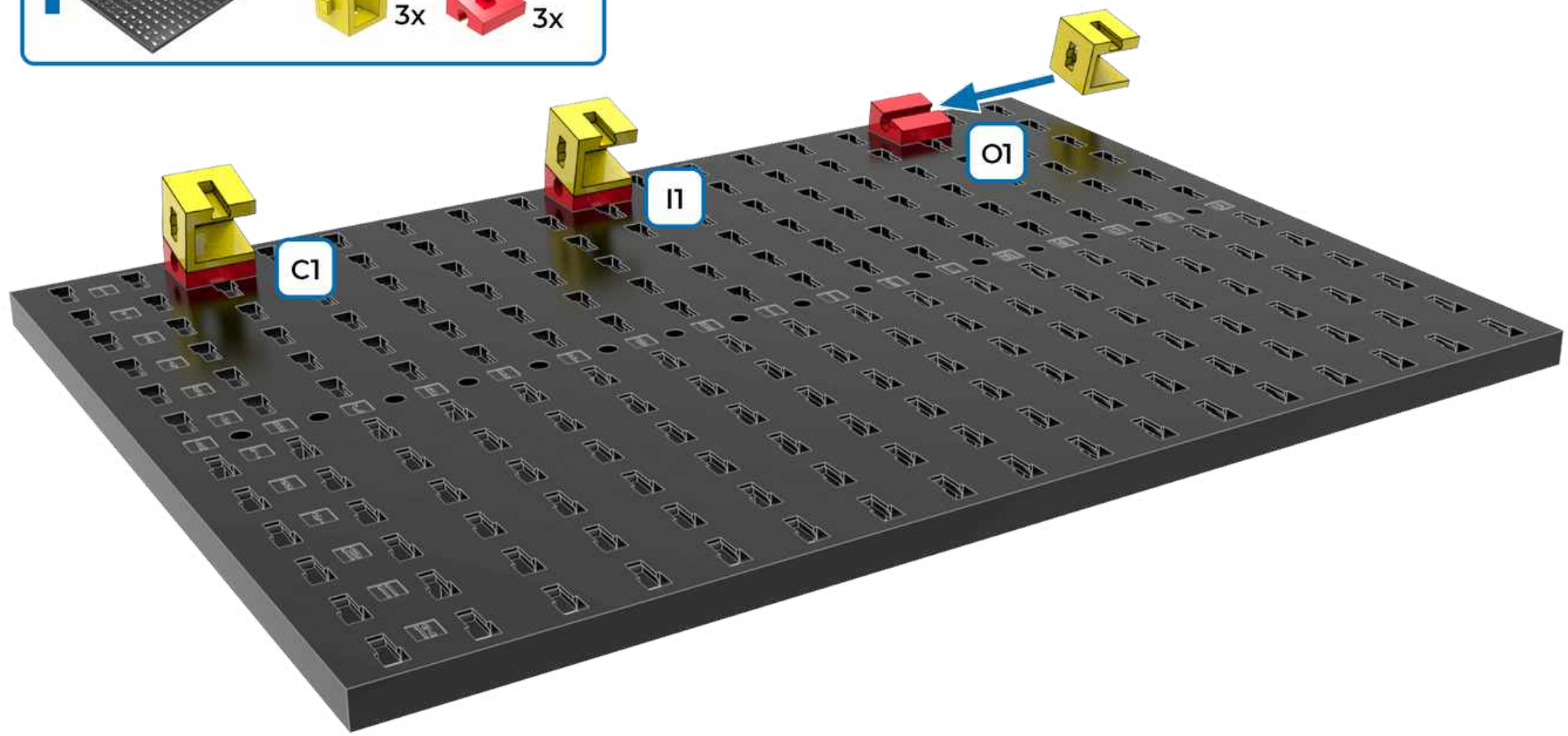

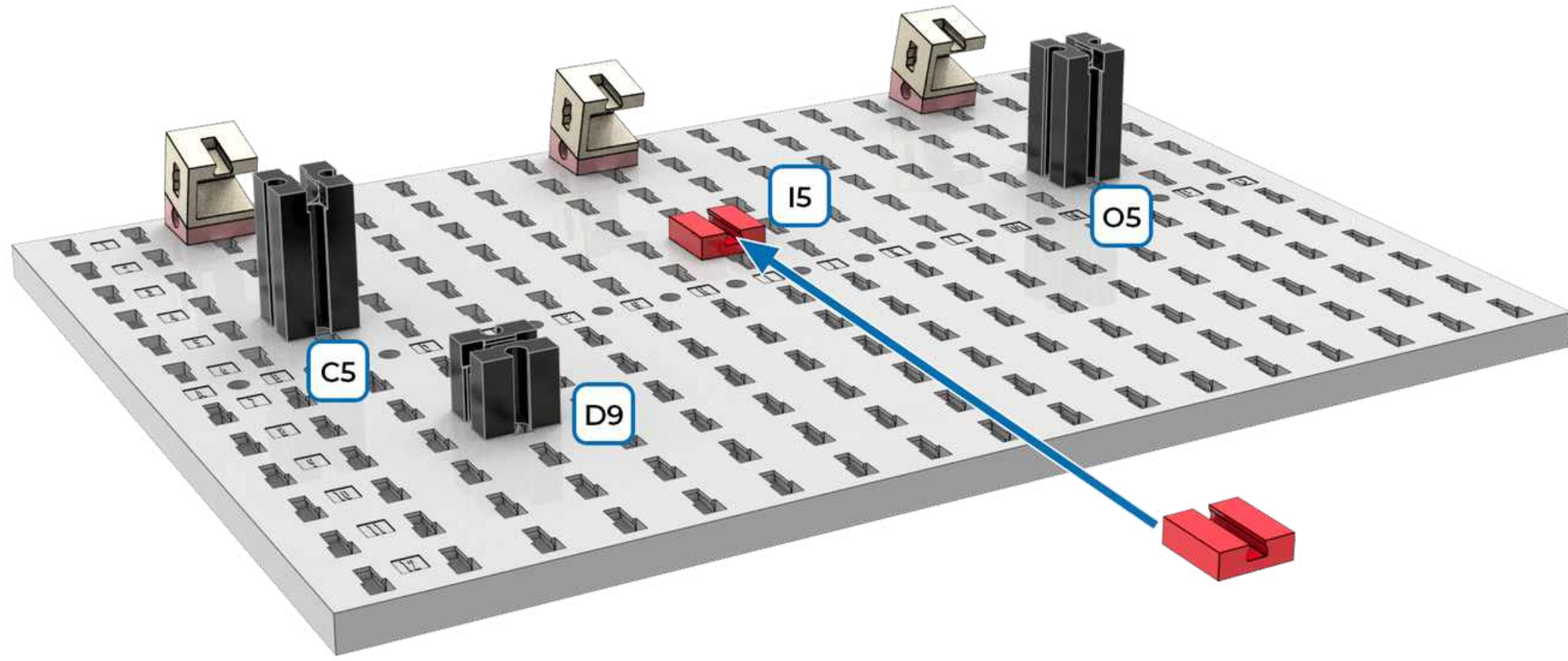
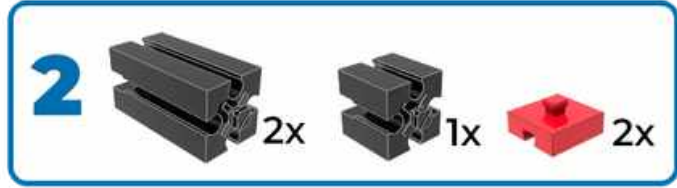
1 1x  3x  3x  3x





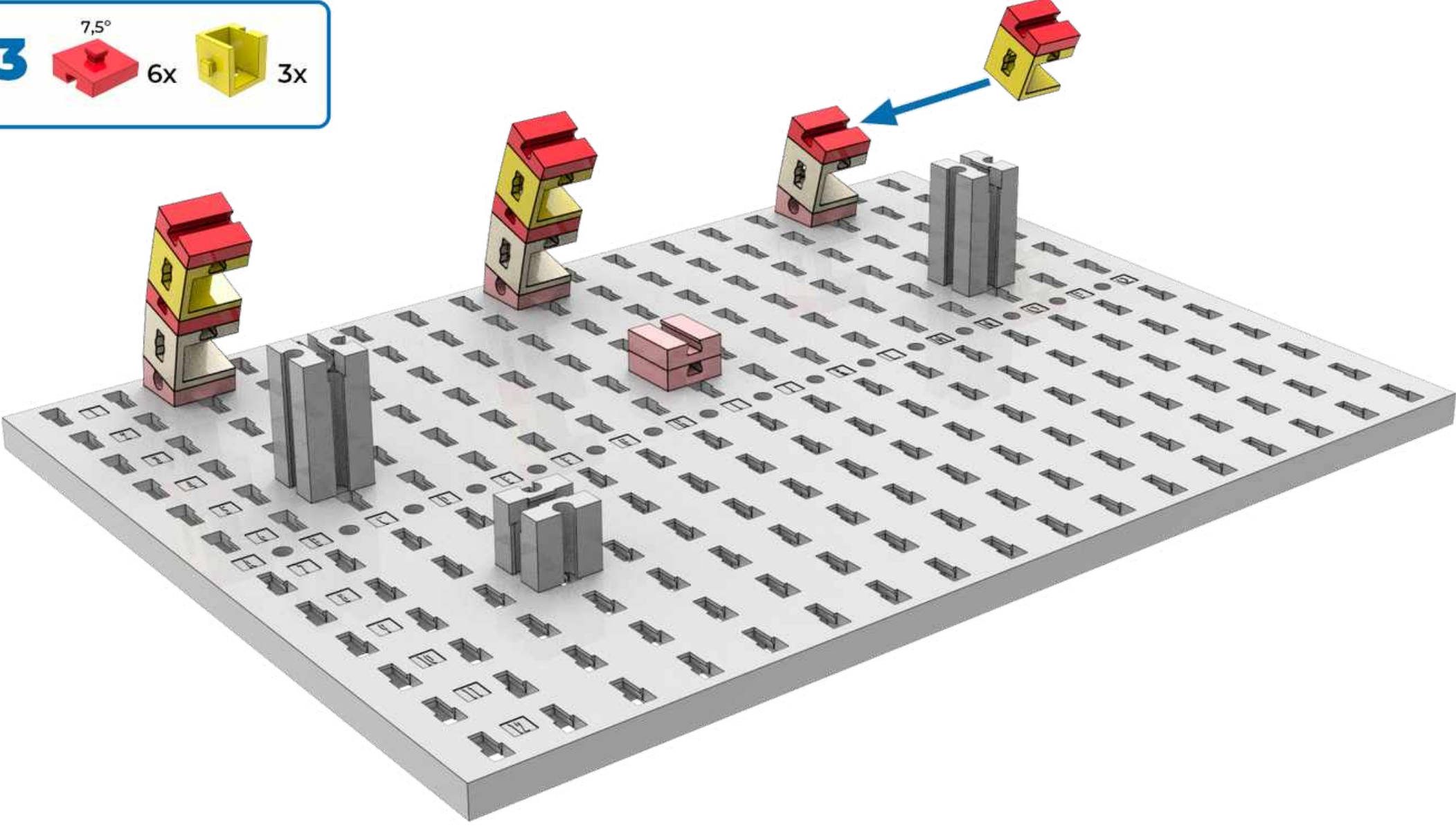

3 $7,5^\circ$ 6x  3x



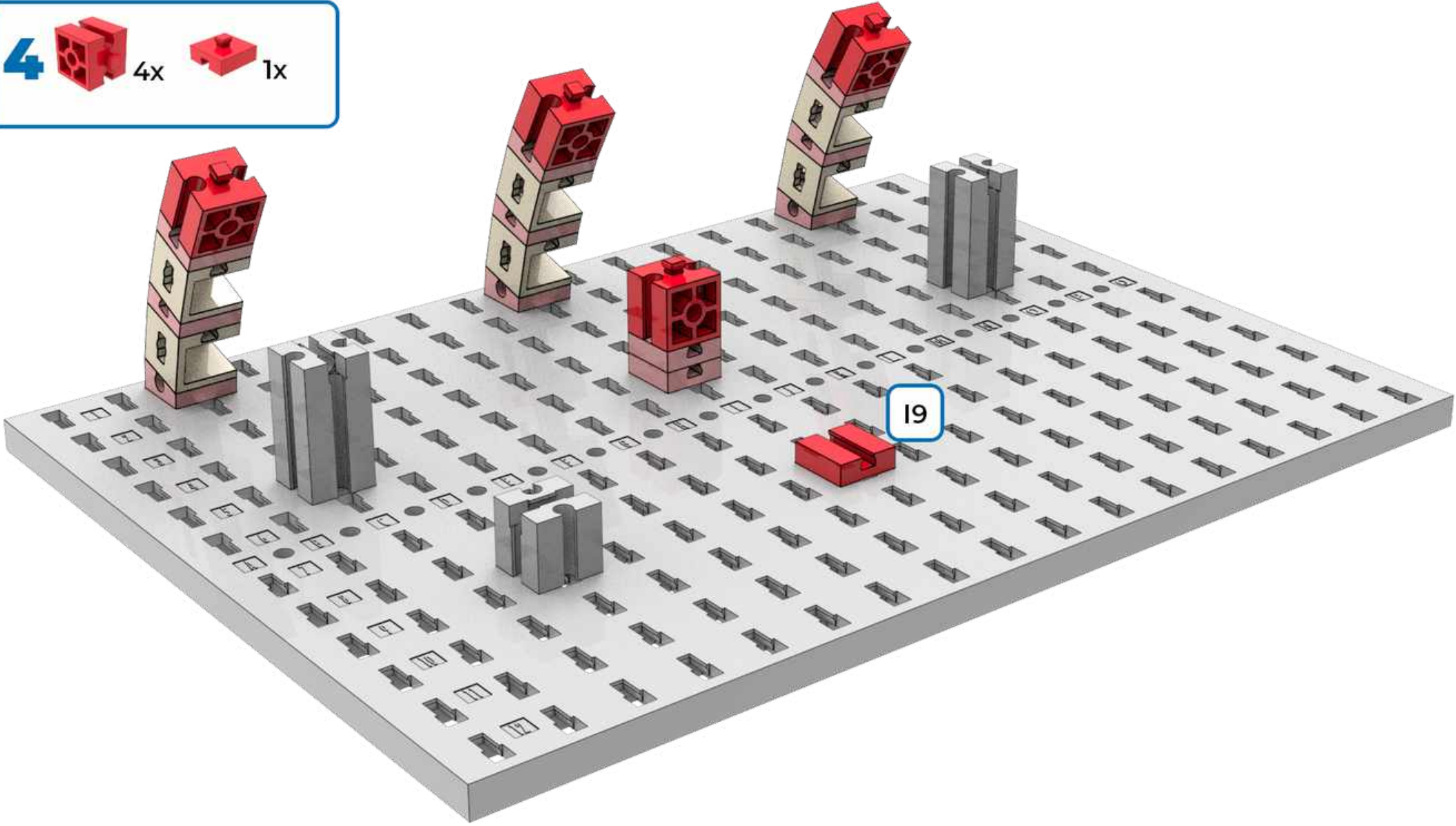

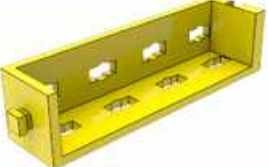
4  4x  1x

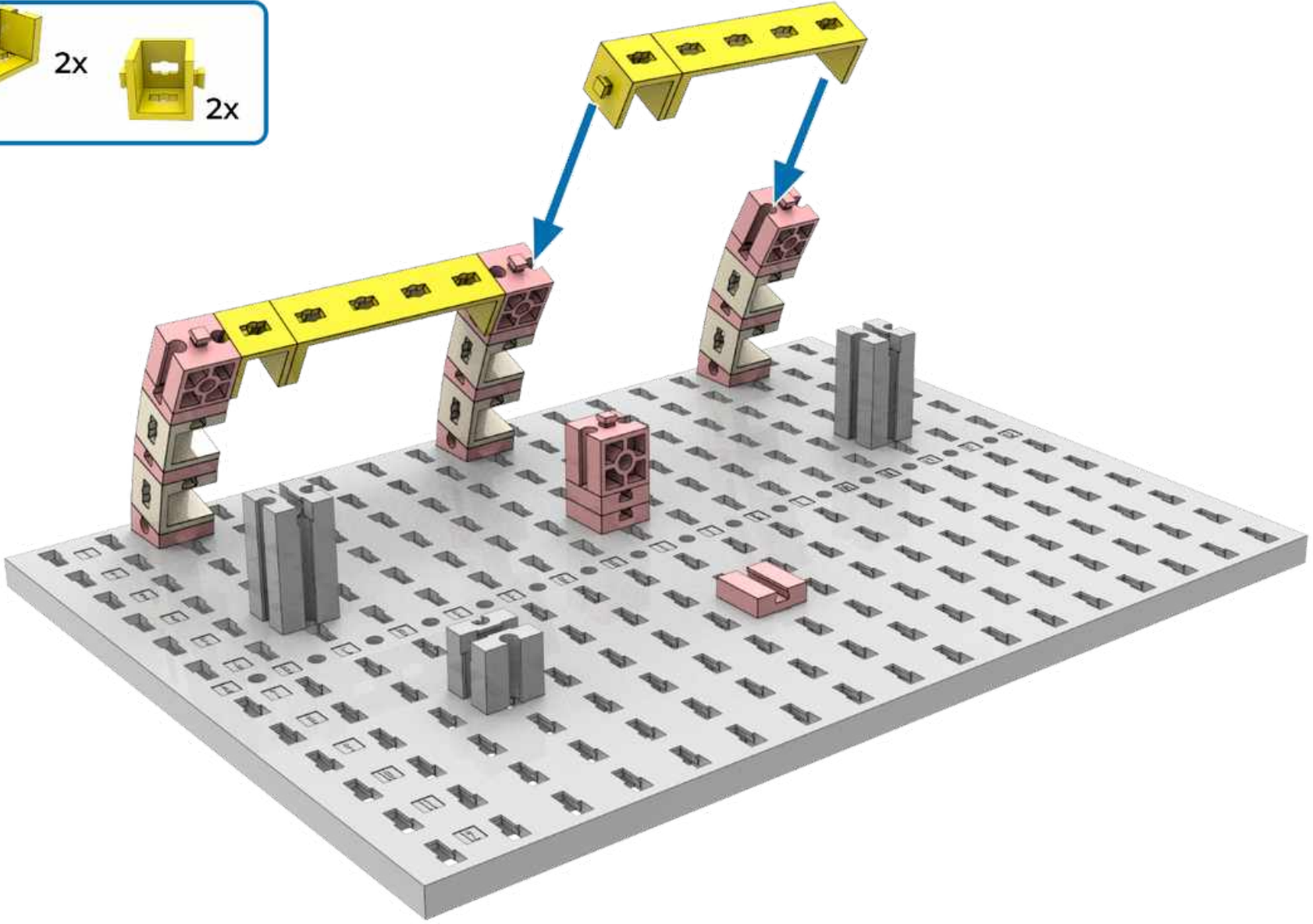

5  2x  2x



6  2x  4x  2x

  2x 

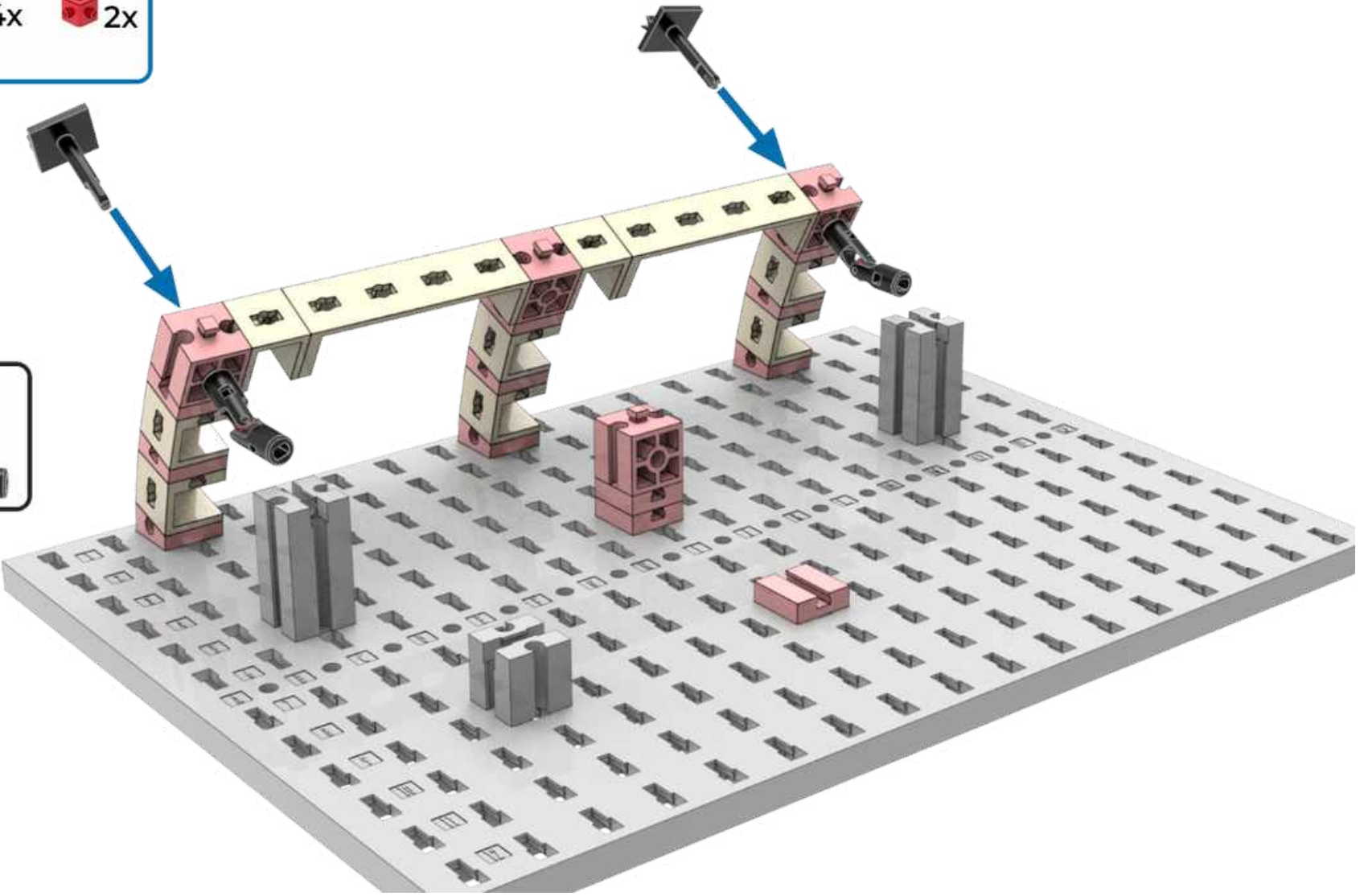

7  2x  2x  2x

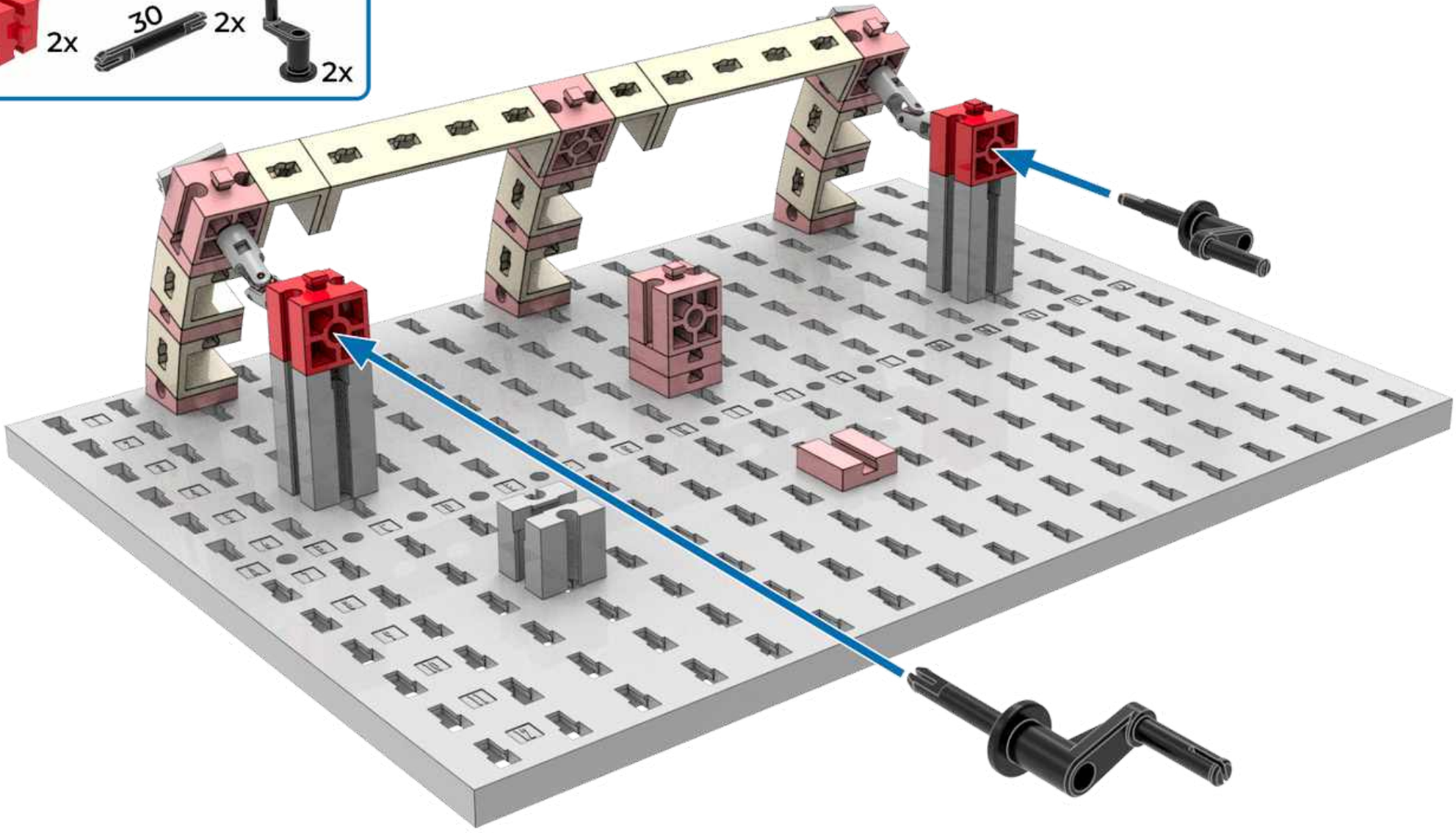

8



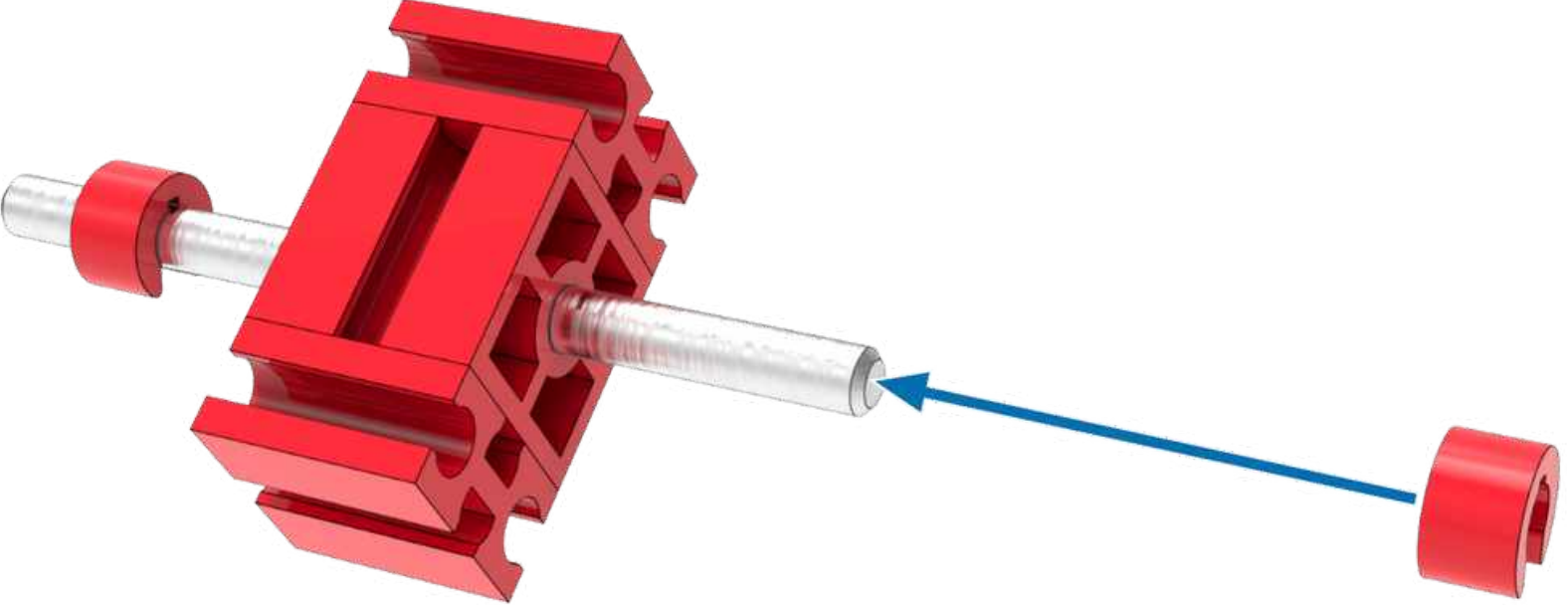

1x 60 1x 2x 2x



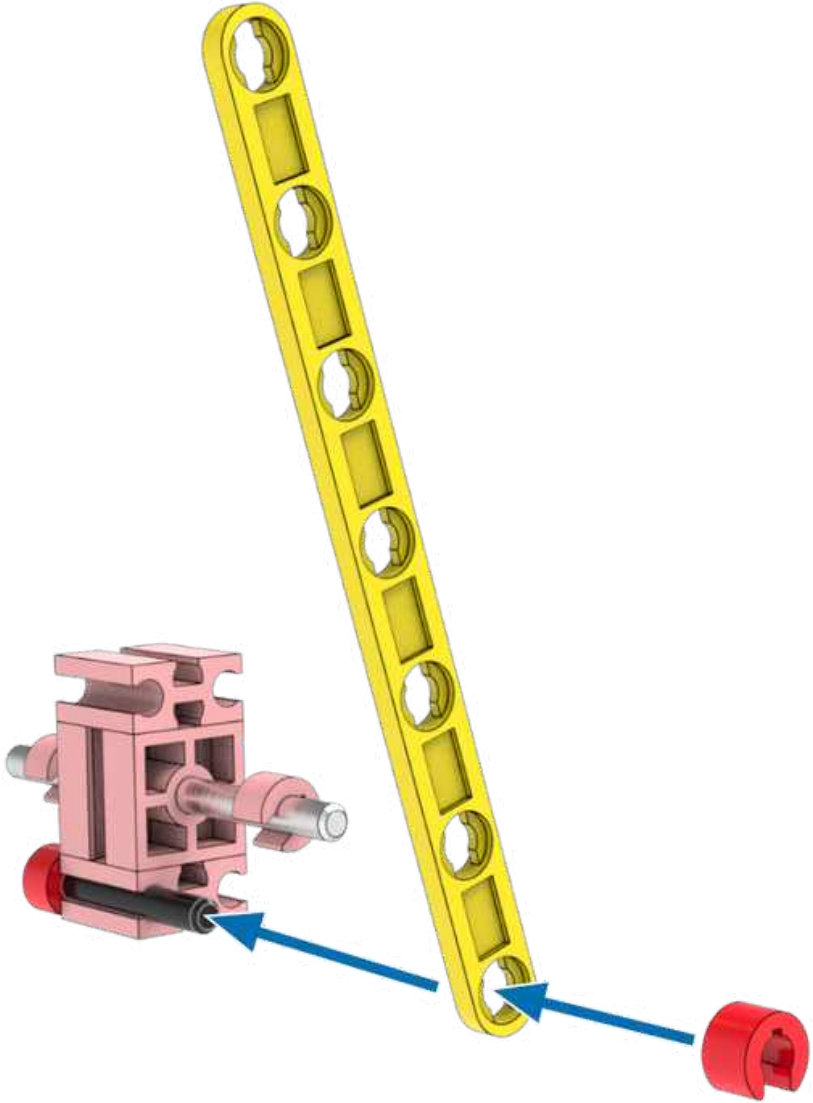

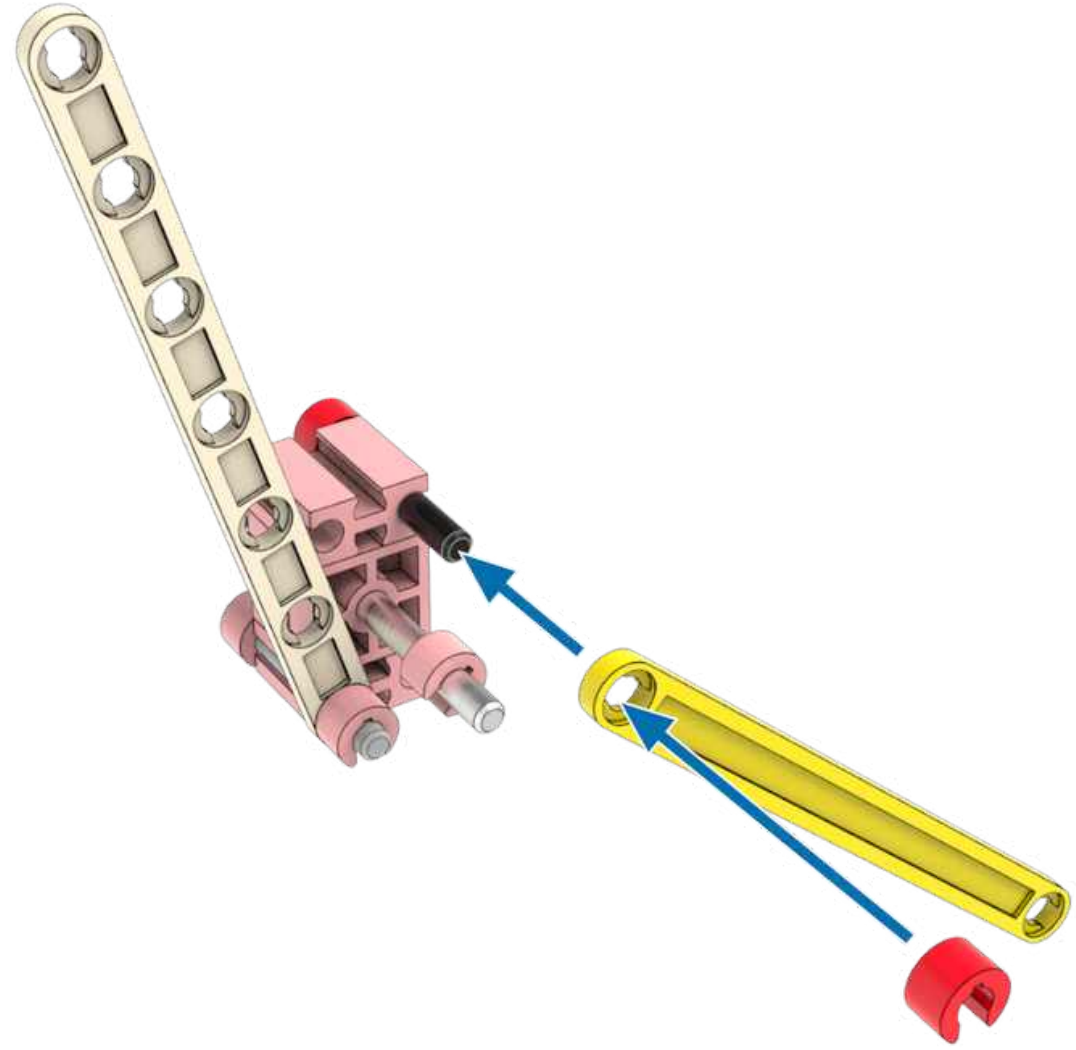
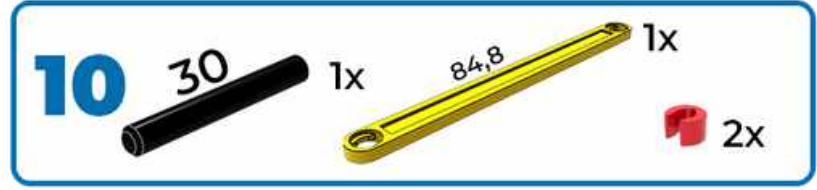

9 30 1x 90 1x 2x



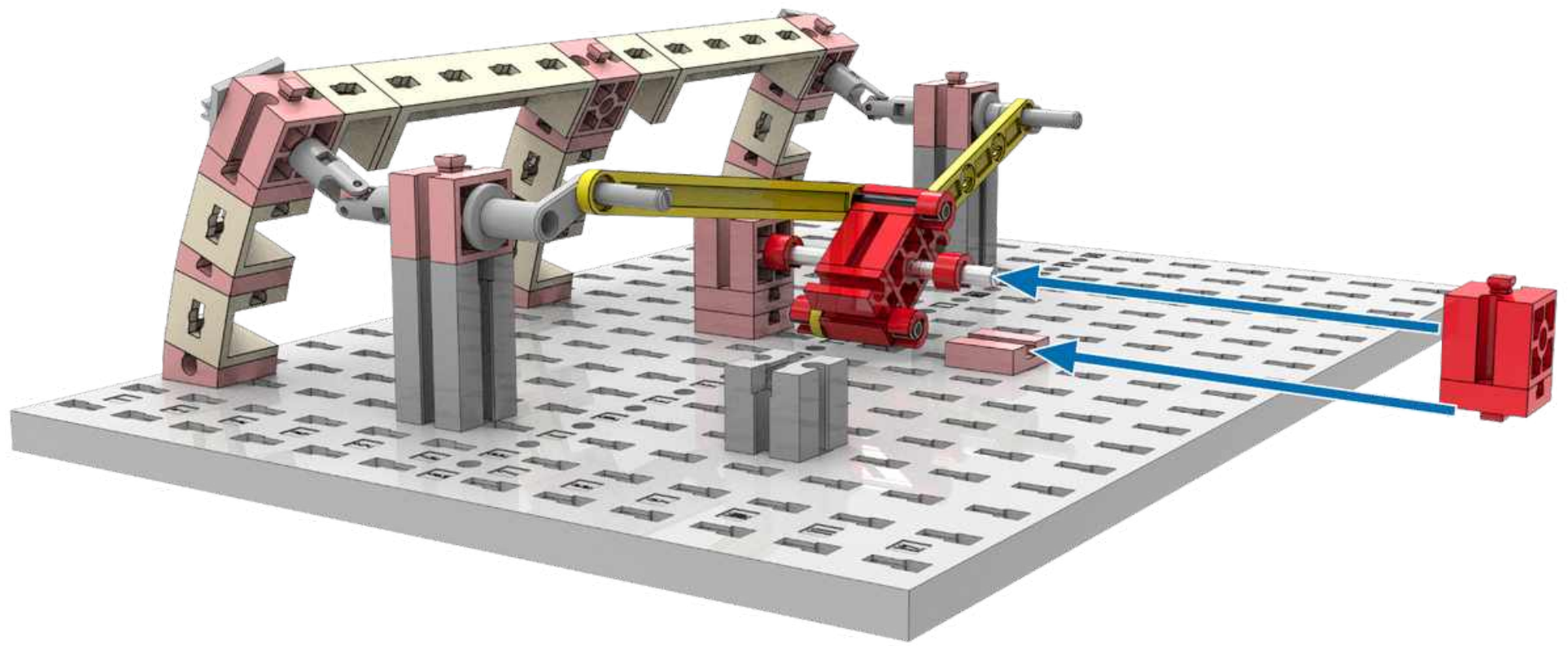

11  1x  1x



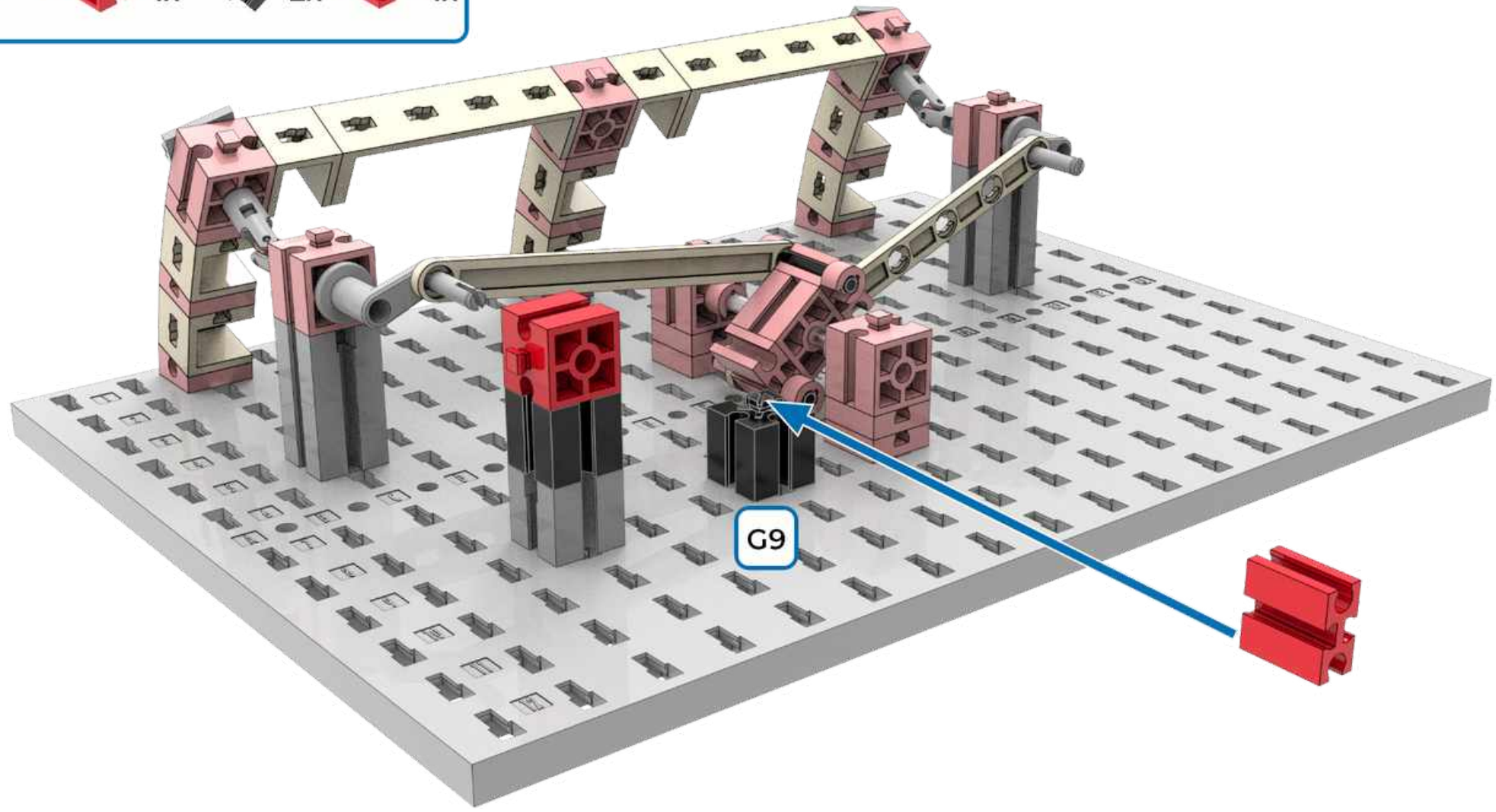

12  1x  2x  1x



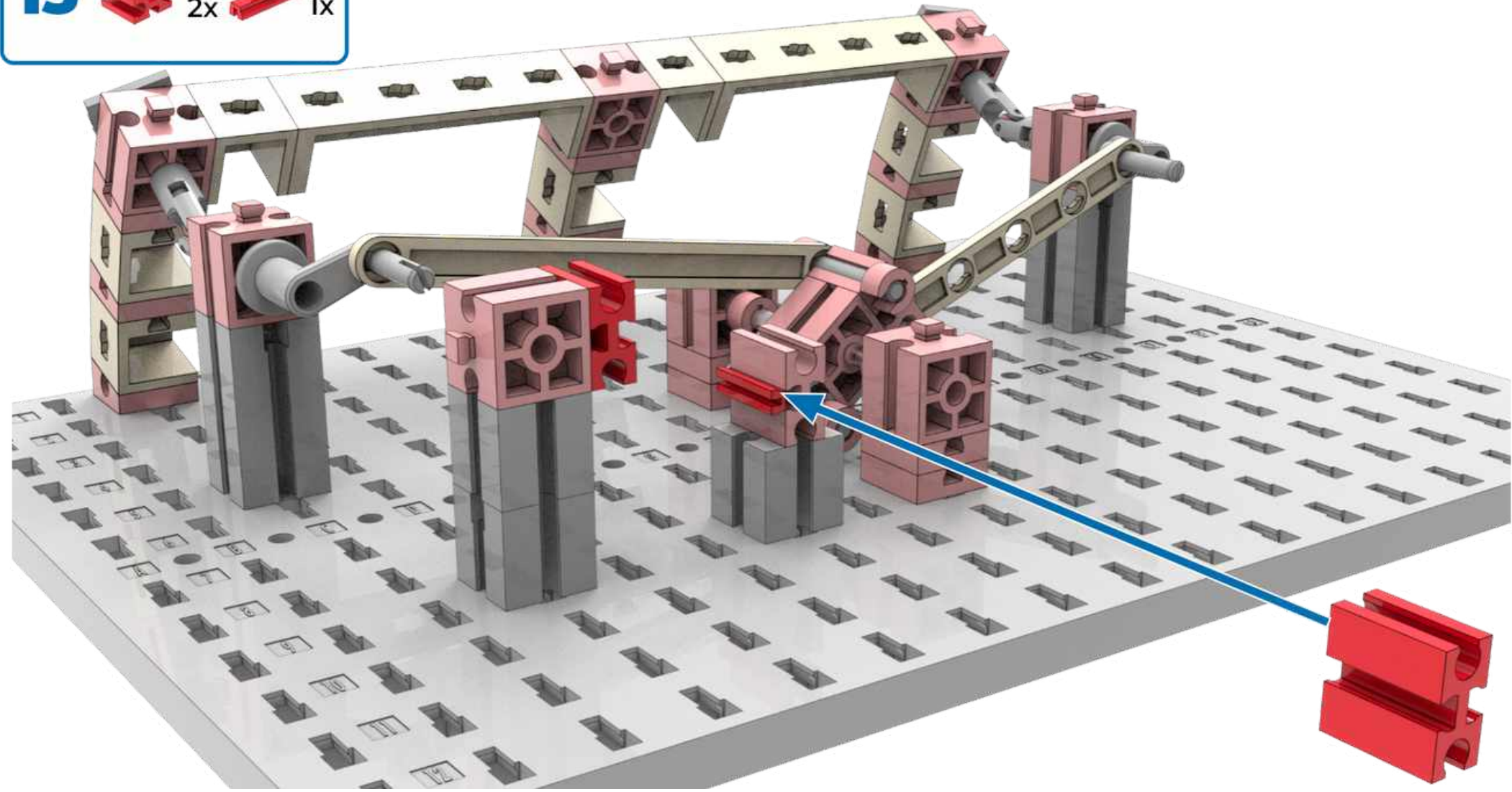



13  2x  1x

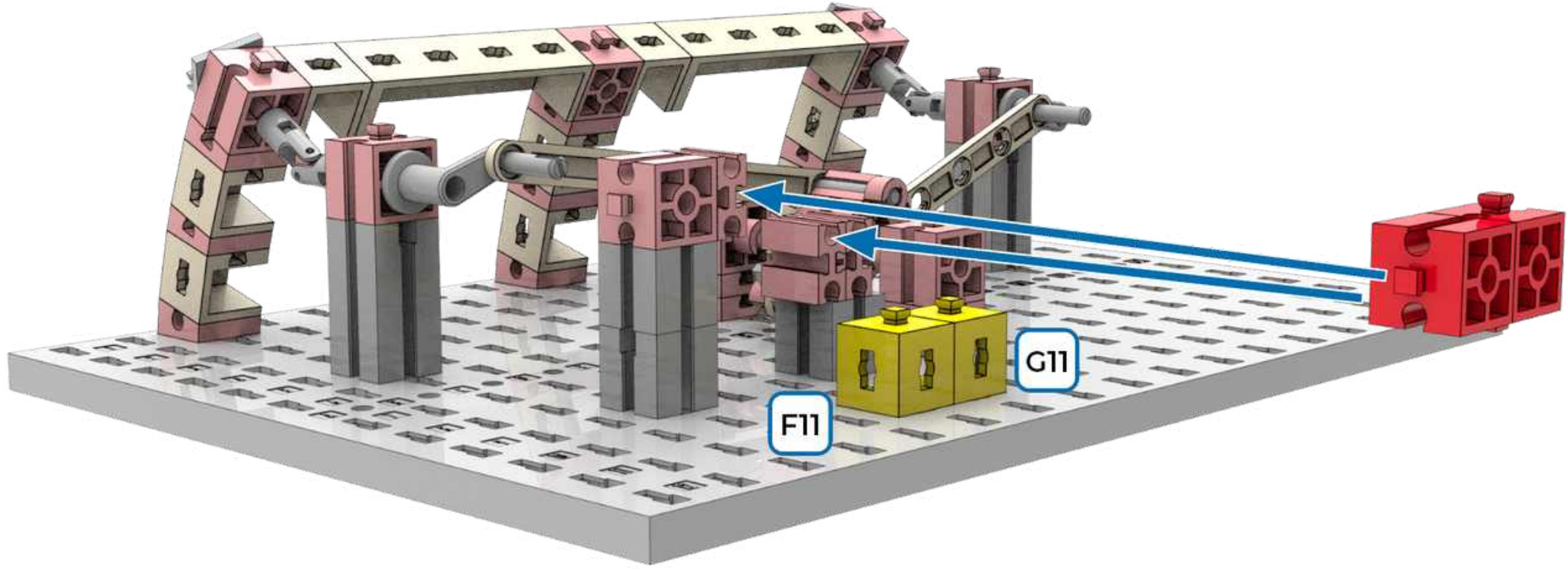



14  2x  2x



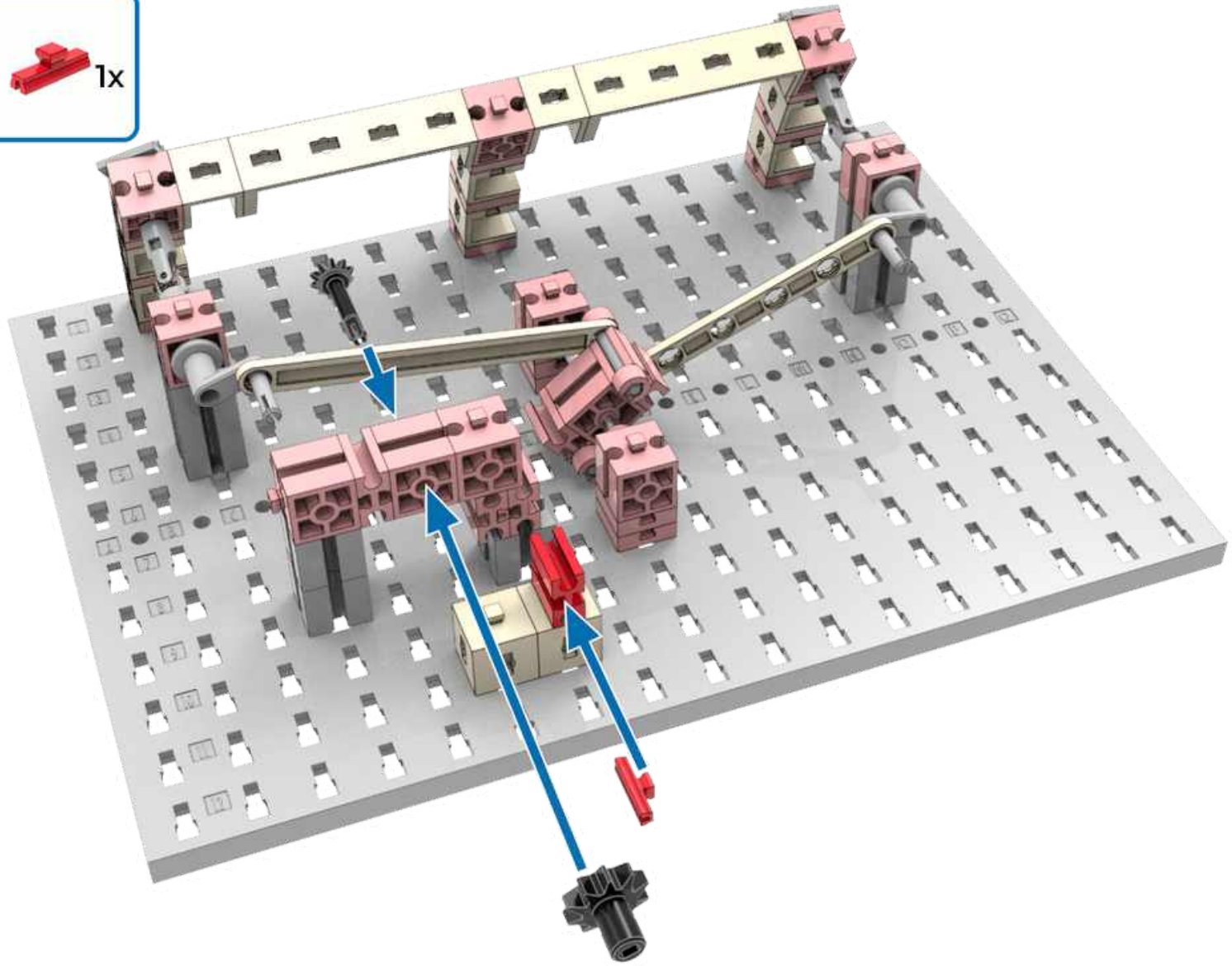

15  1x  1x  1x  1x



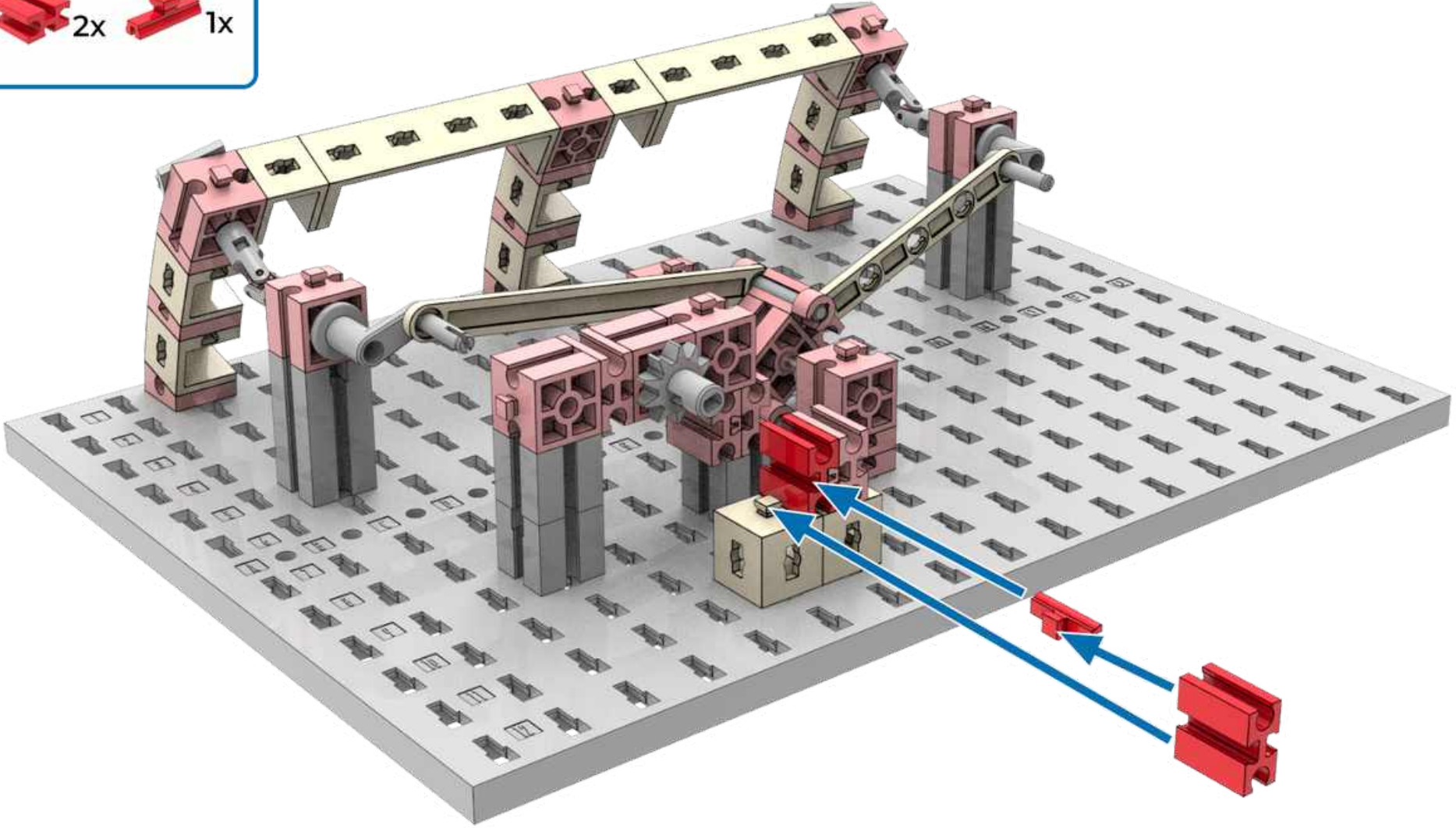

16  2x  1x

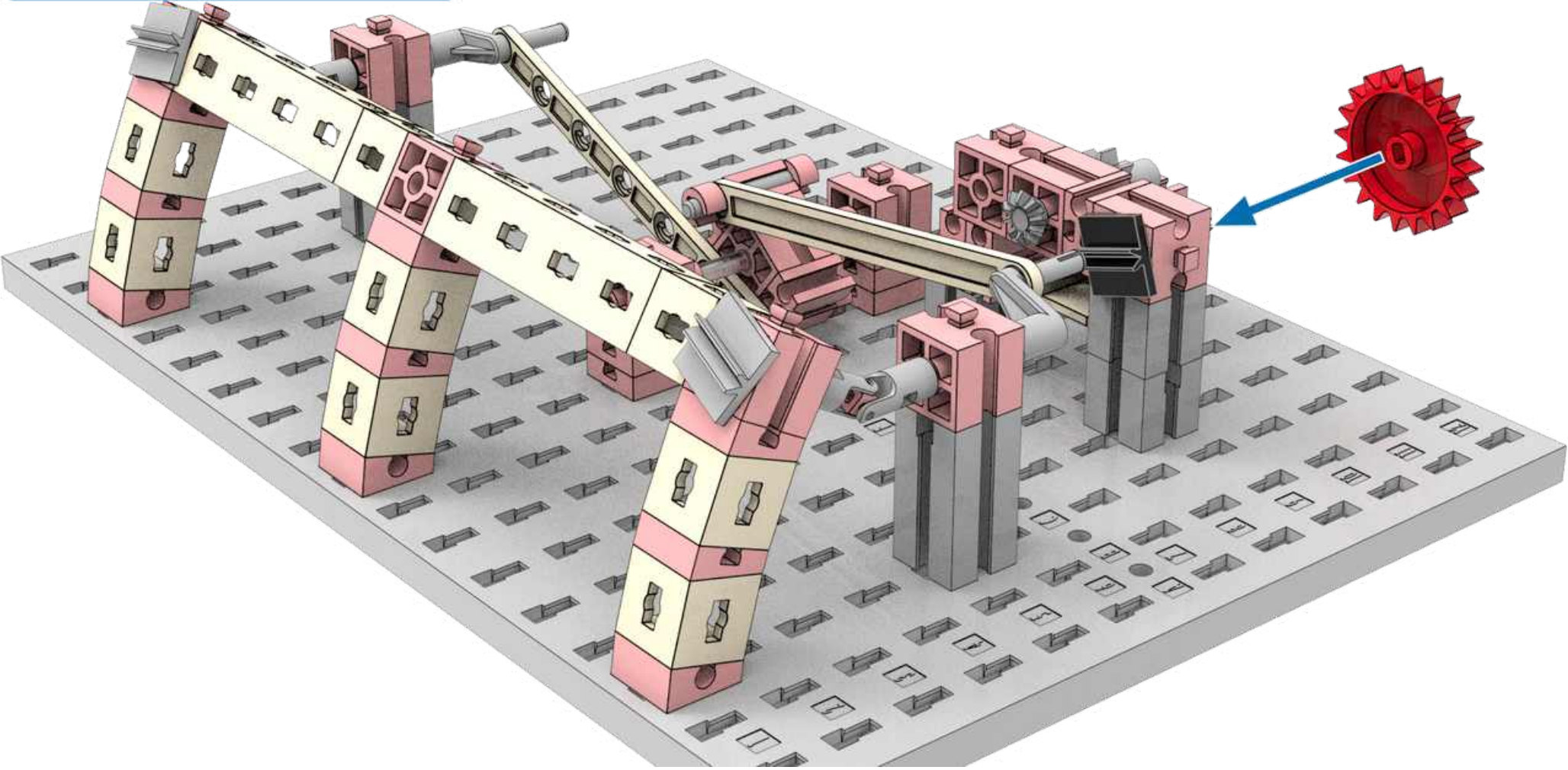

17  1x  1x



18  1x  1x

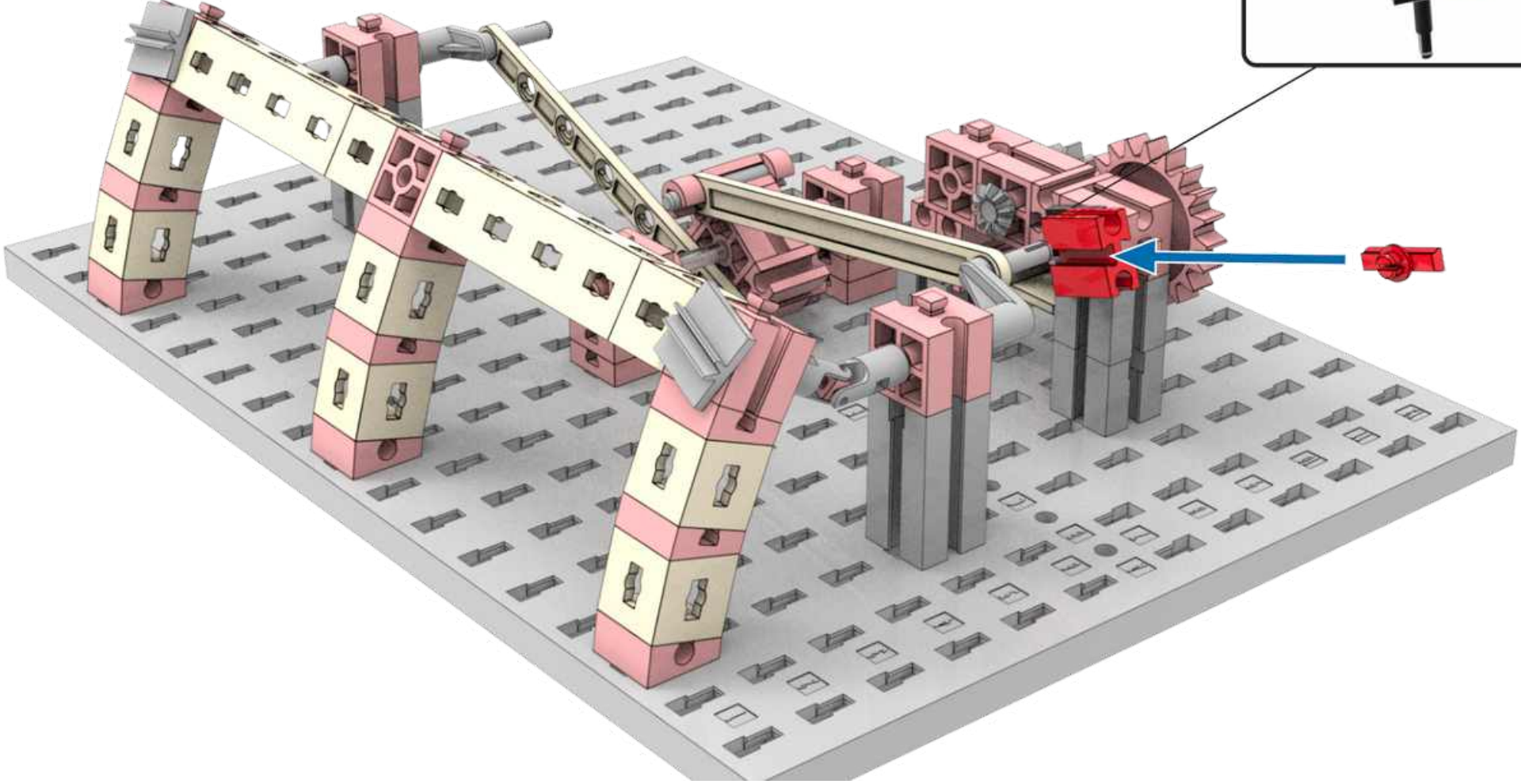

19 30 1x 75 1x
2x

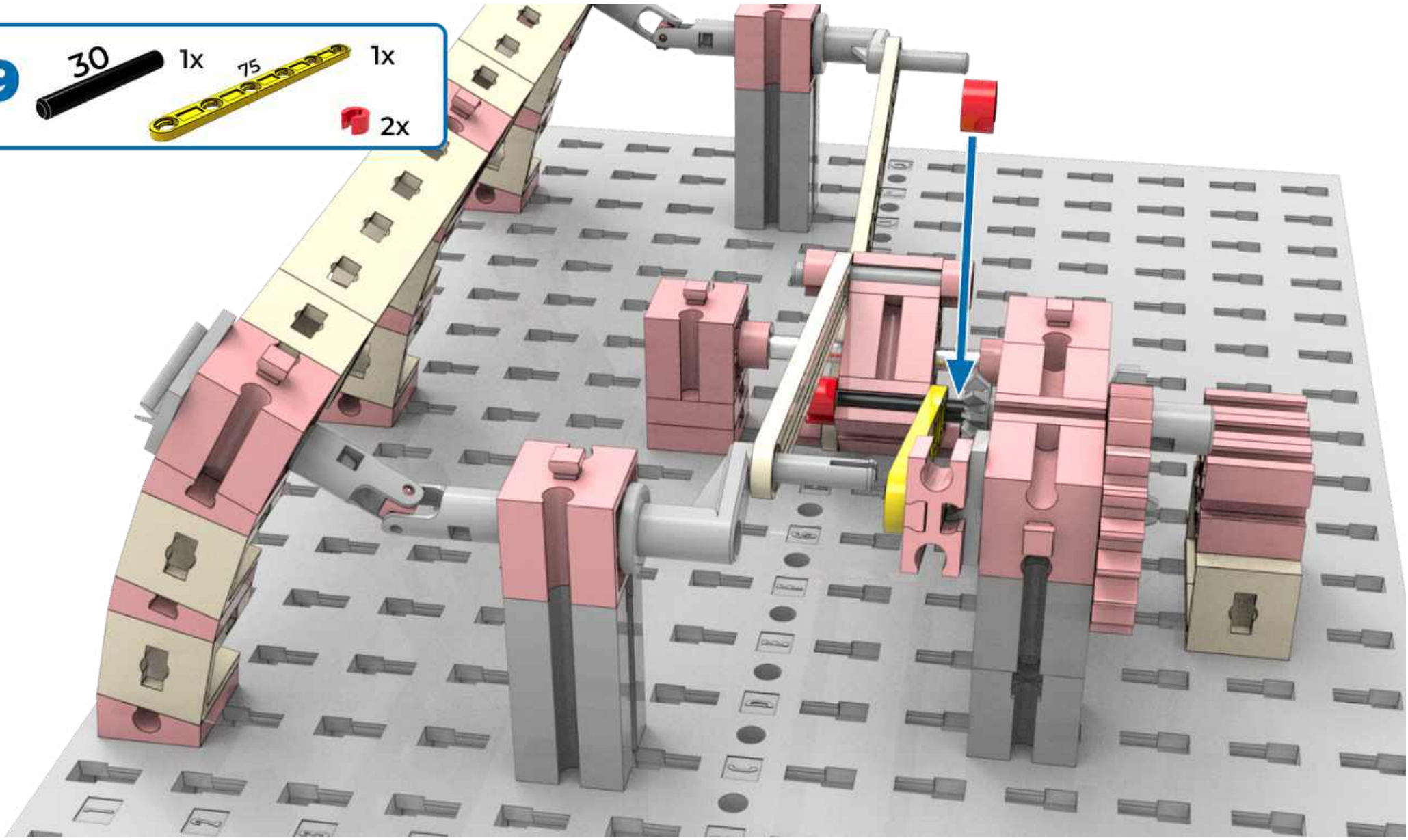



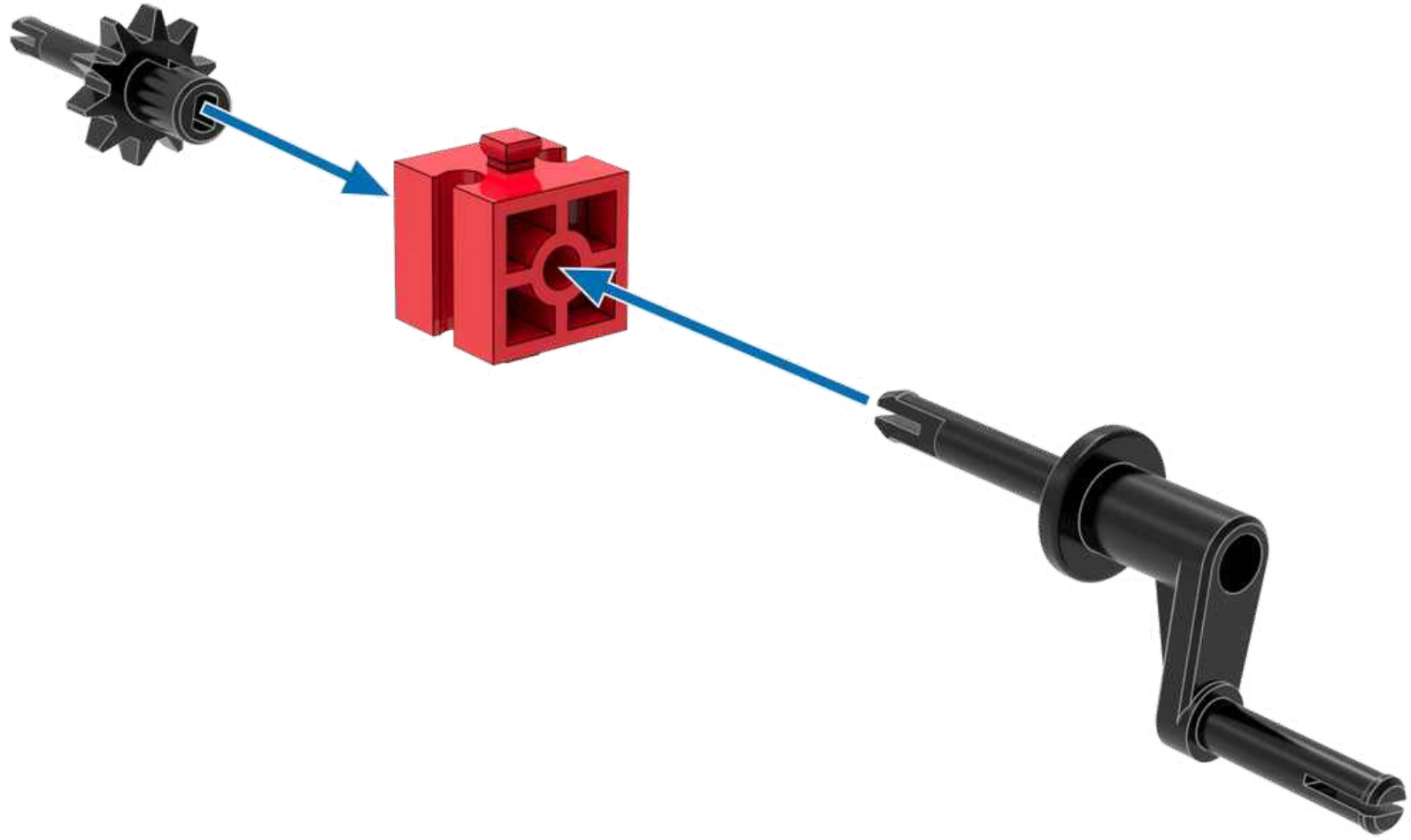

20  1x  2x  1x  1x

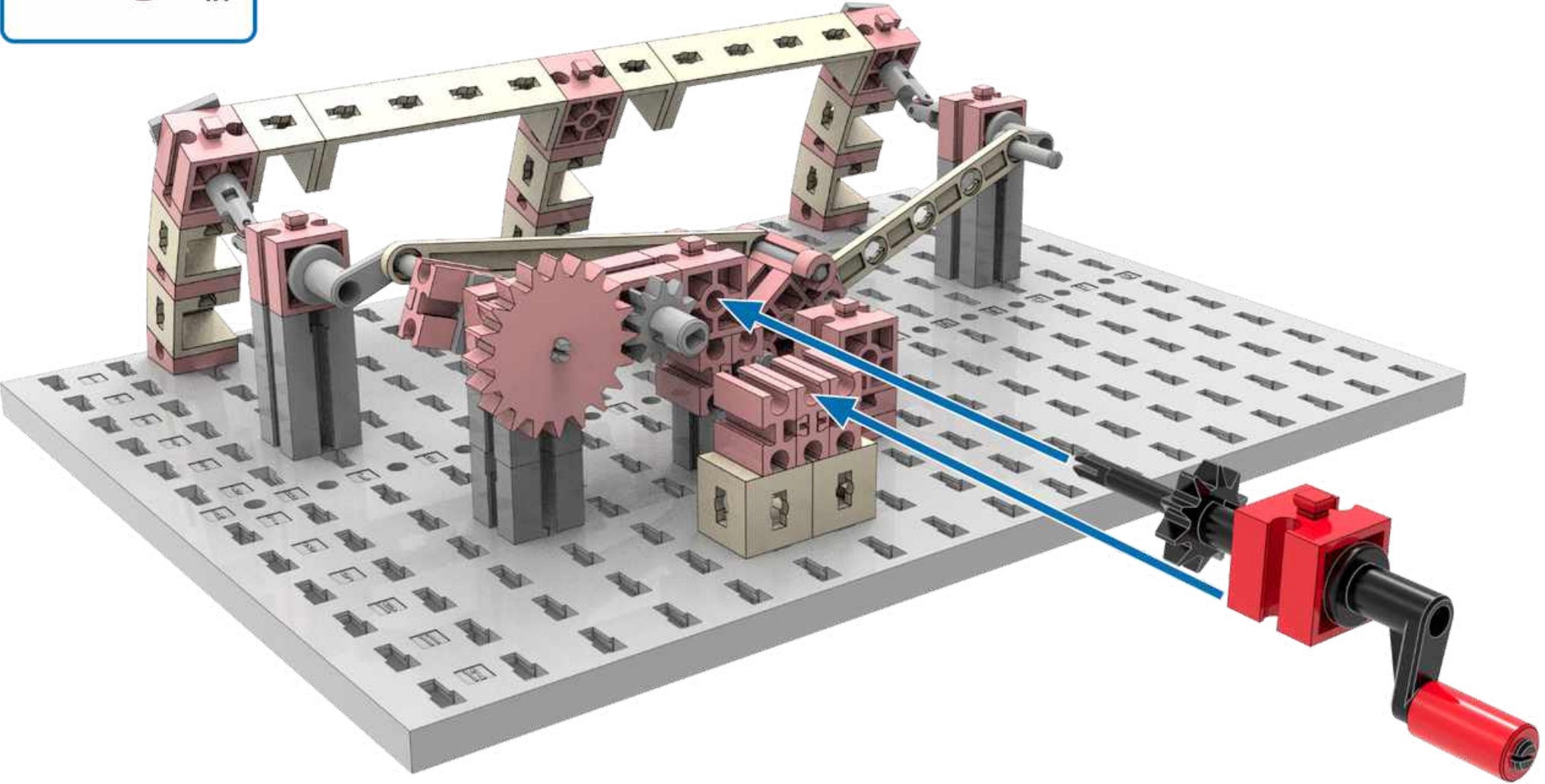

21  1x



22  1x  1x  1x  15° 1x  1x





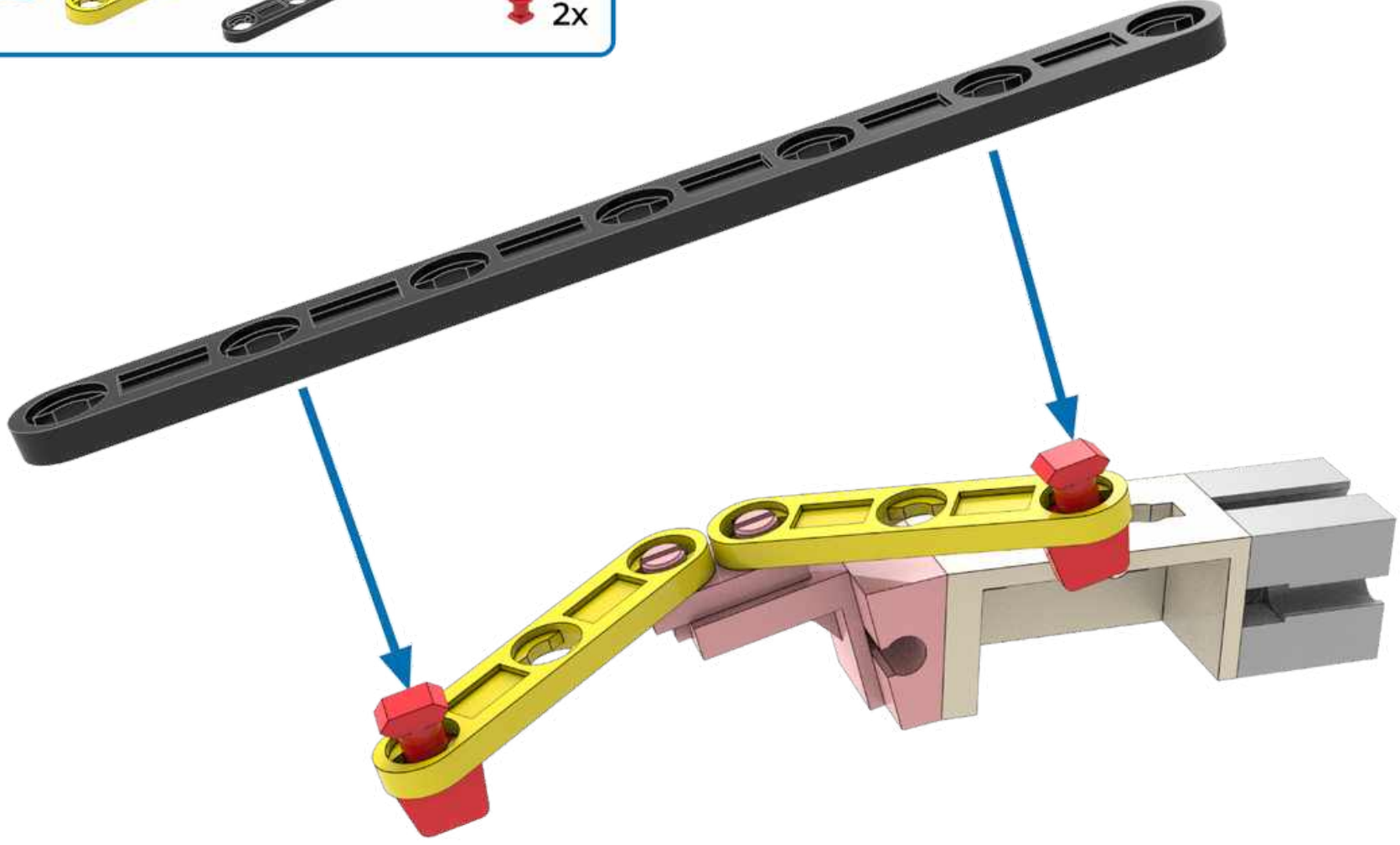

23 30 2x 90 1x 4 2x

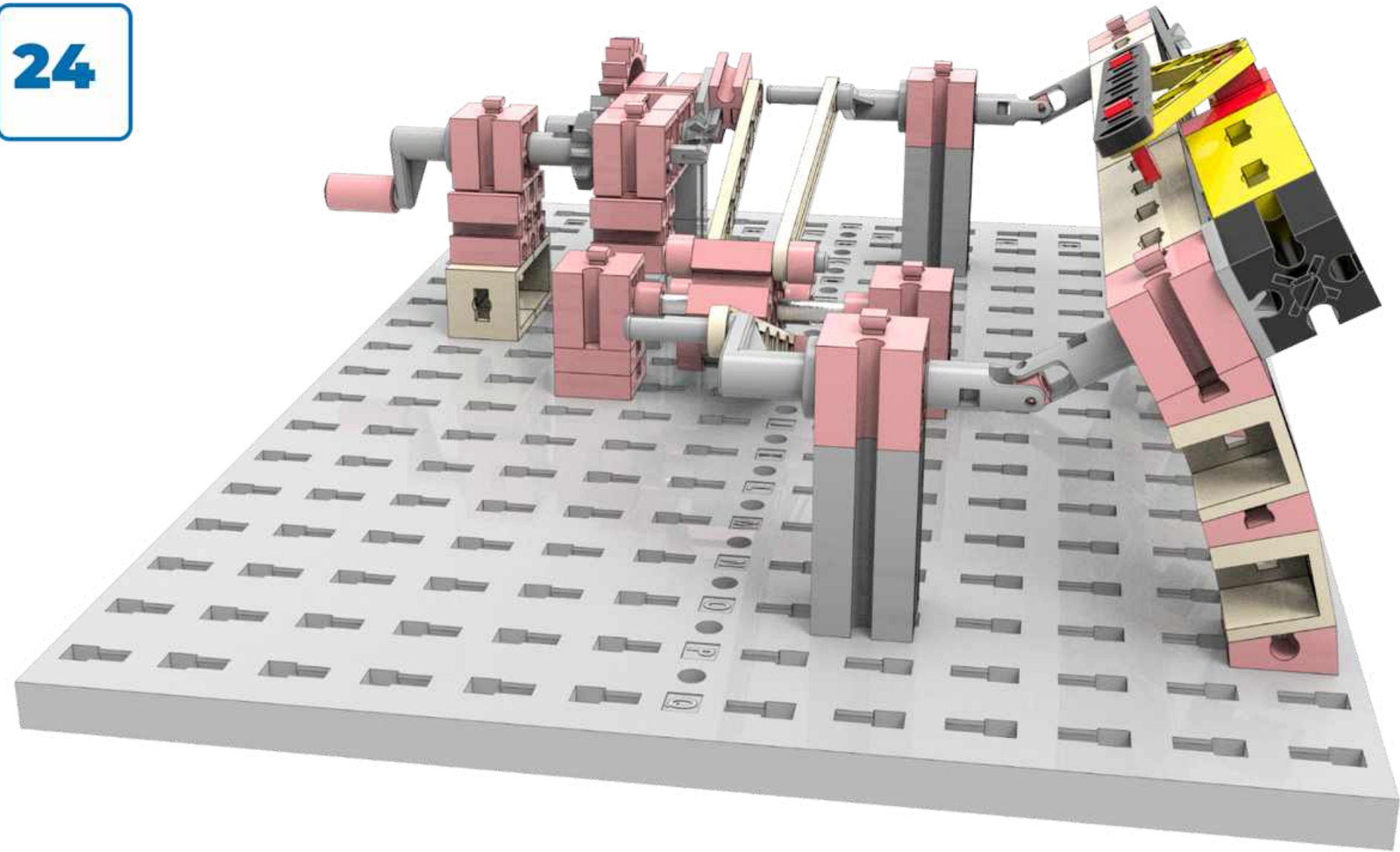

24



25  1x  1x  1x  1x  1x

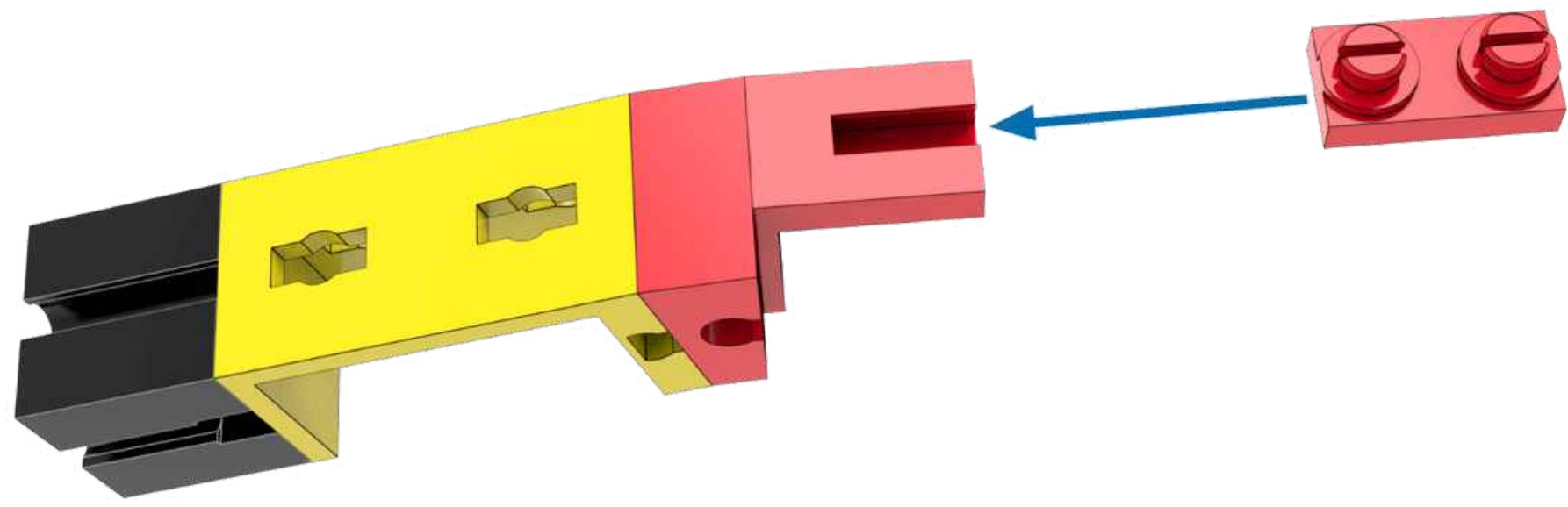

26 30 2x 90 1x ⁴ 2x

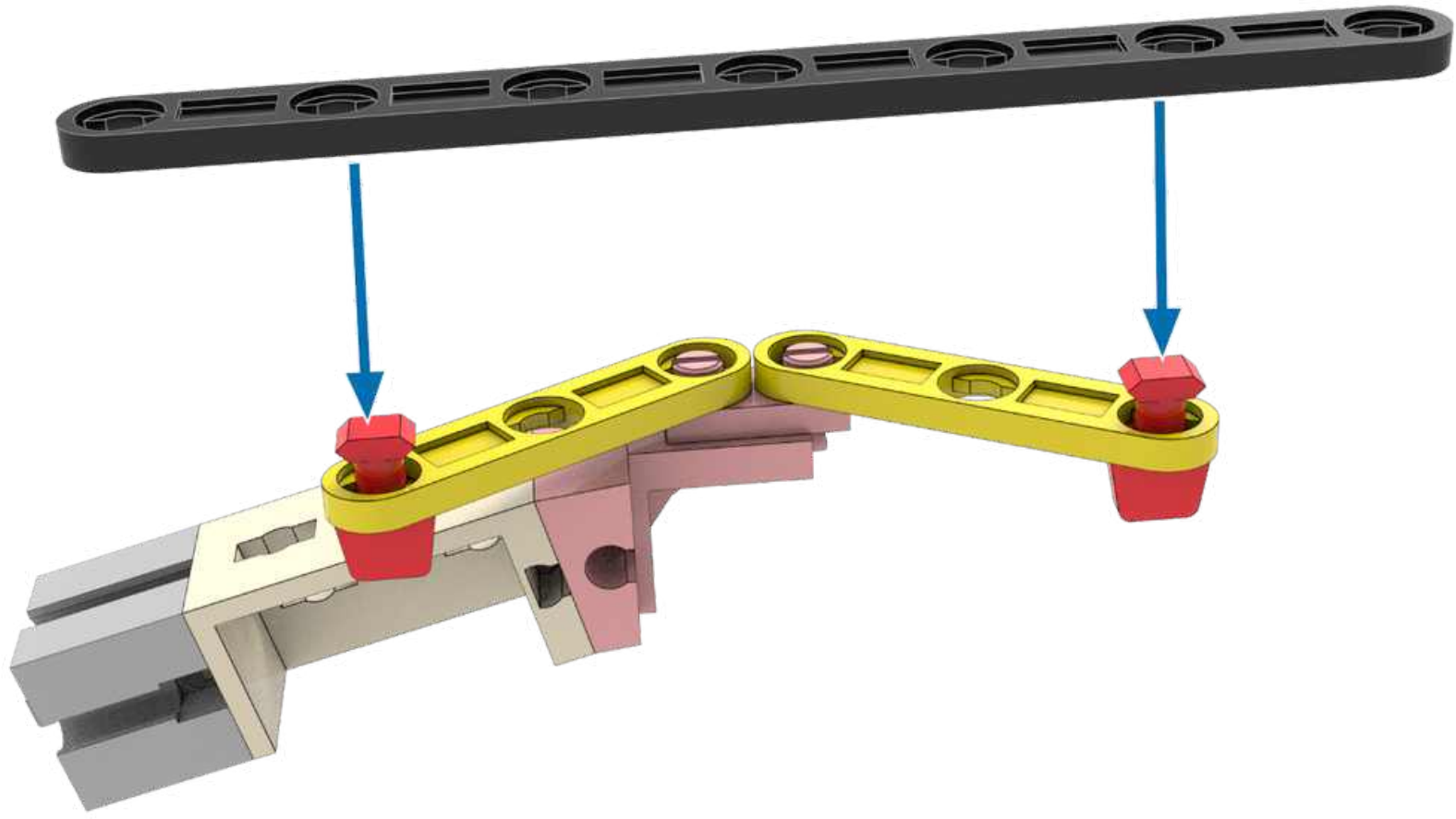



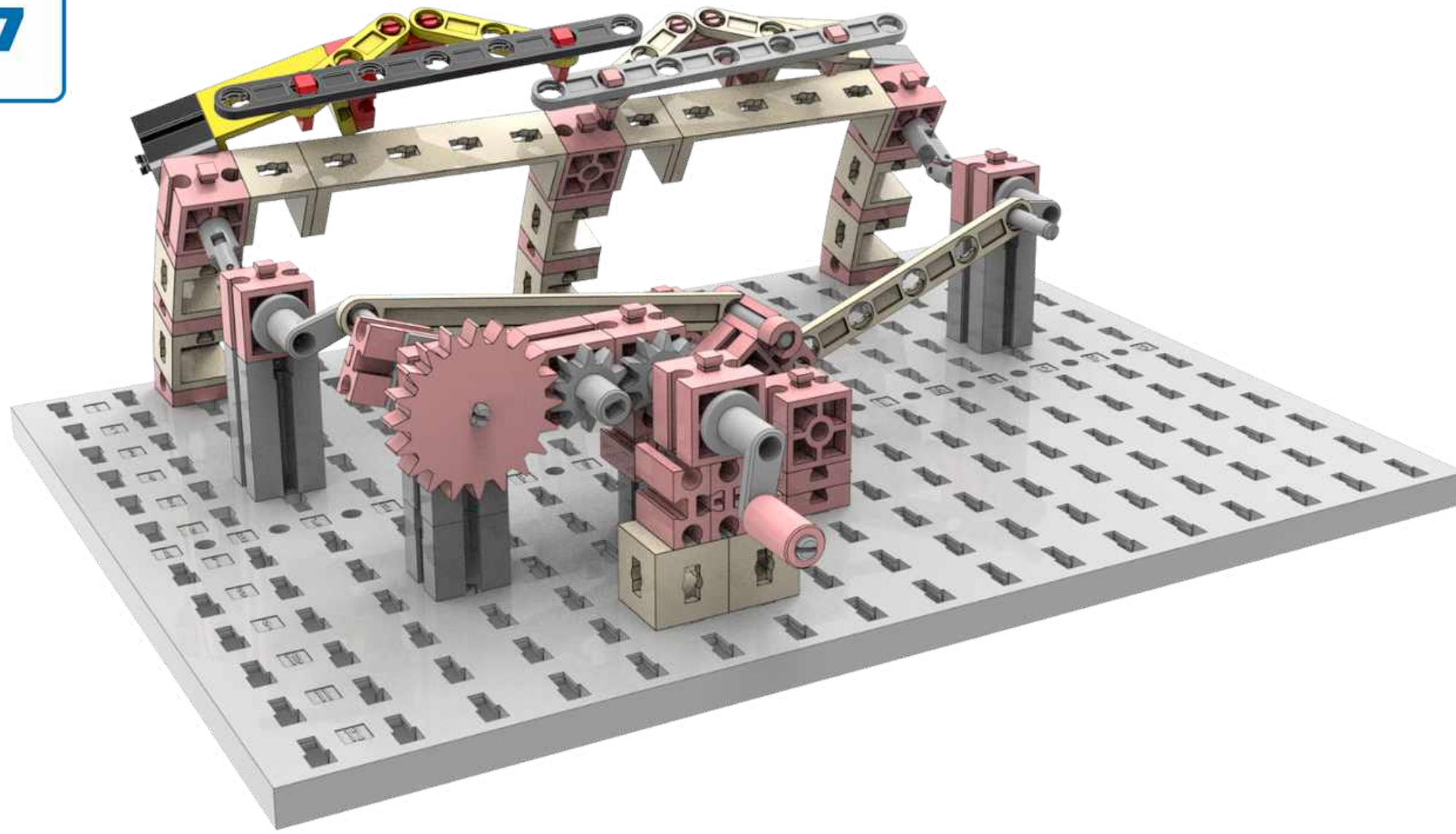

27







Scheibenwischer parallel

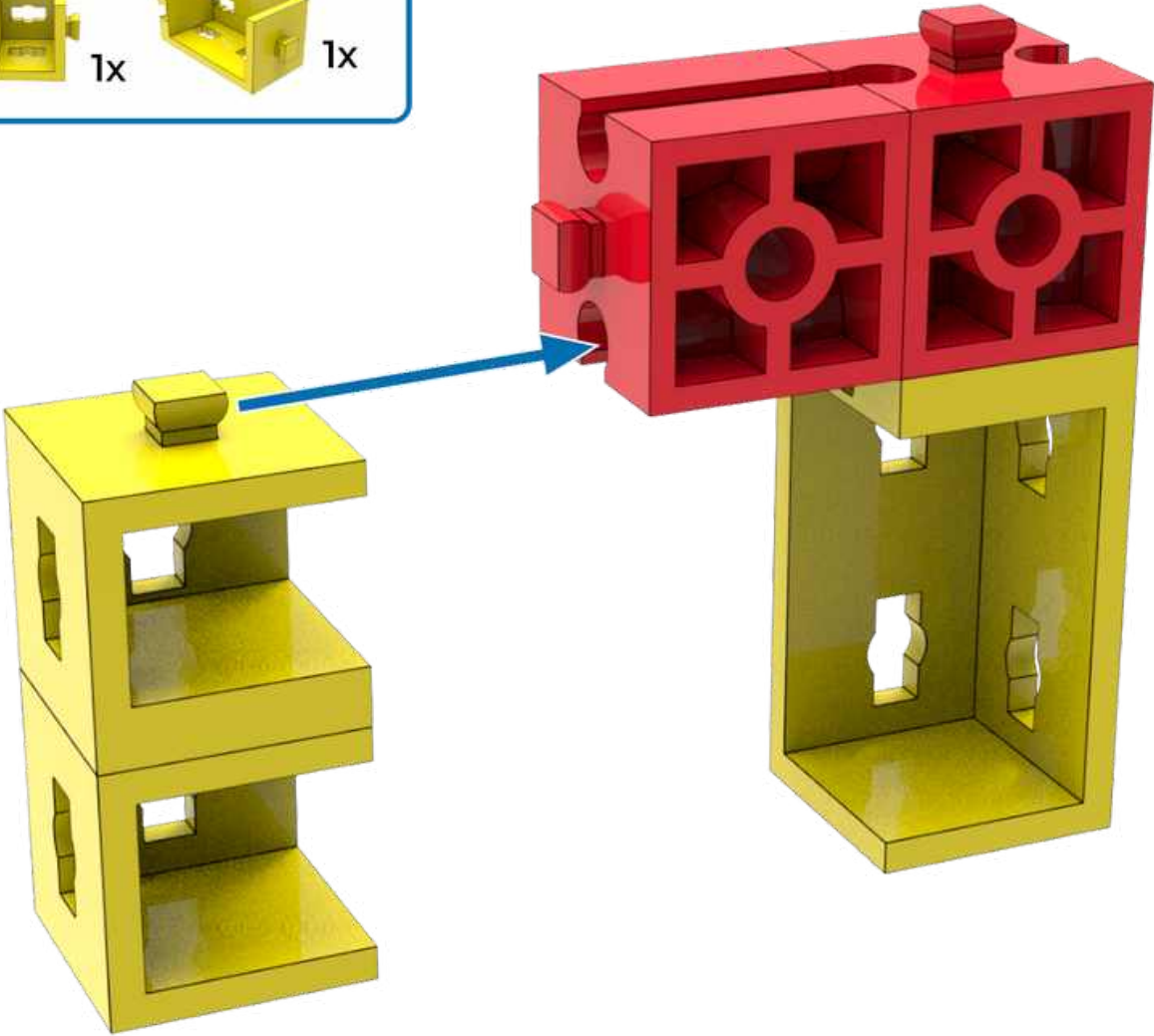

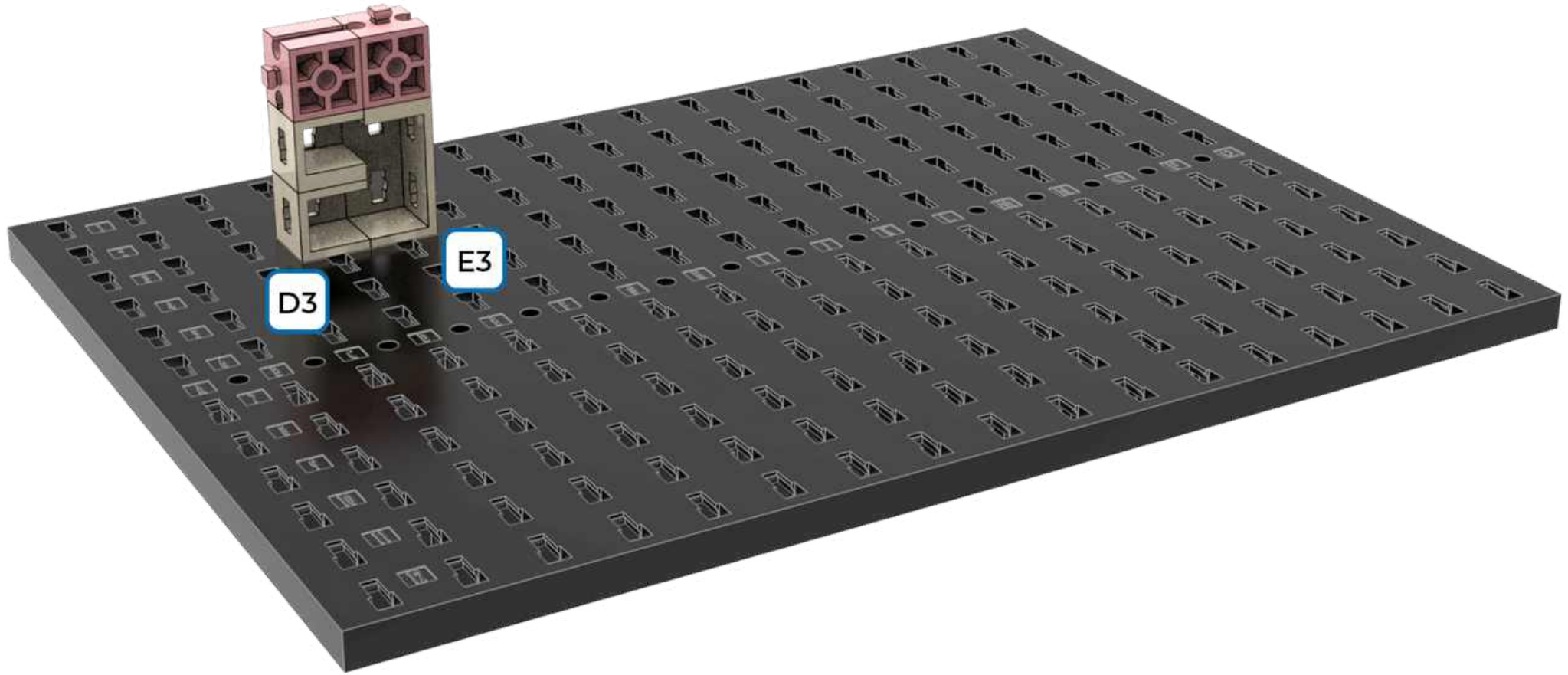
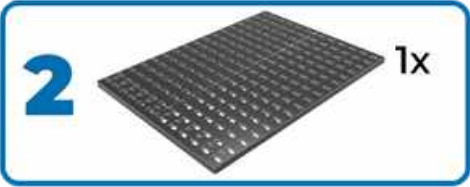
1  2x  1x  1x  1x







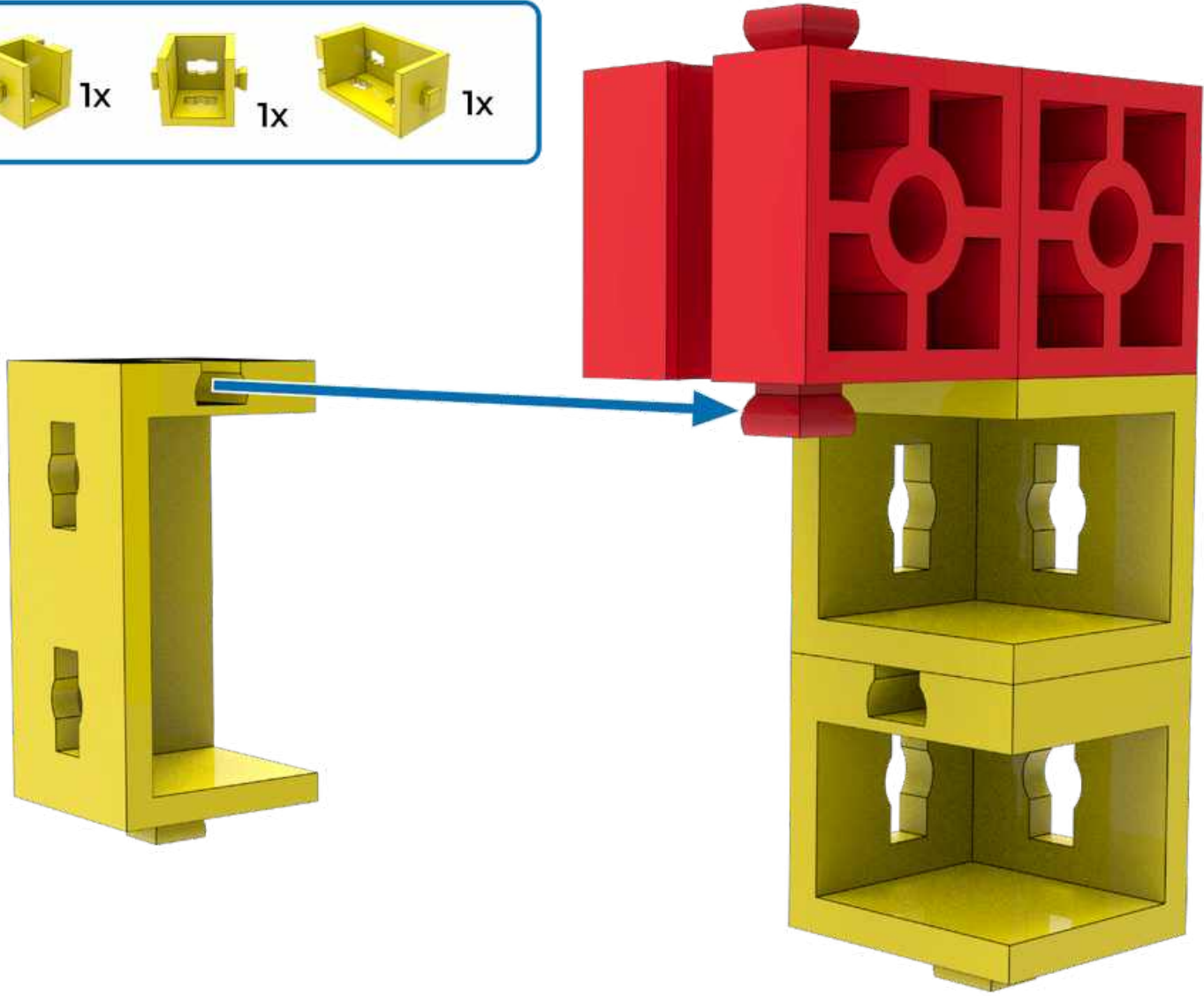

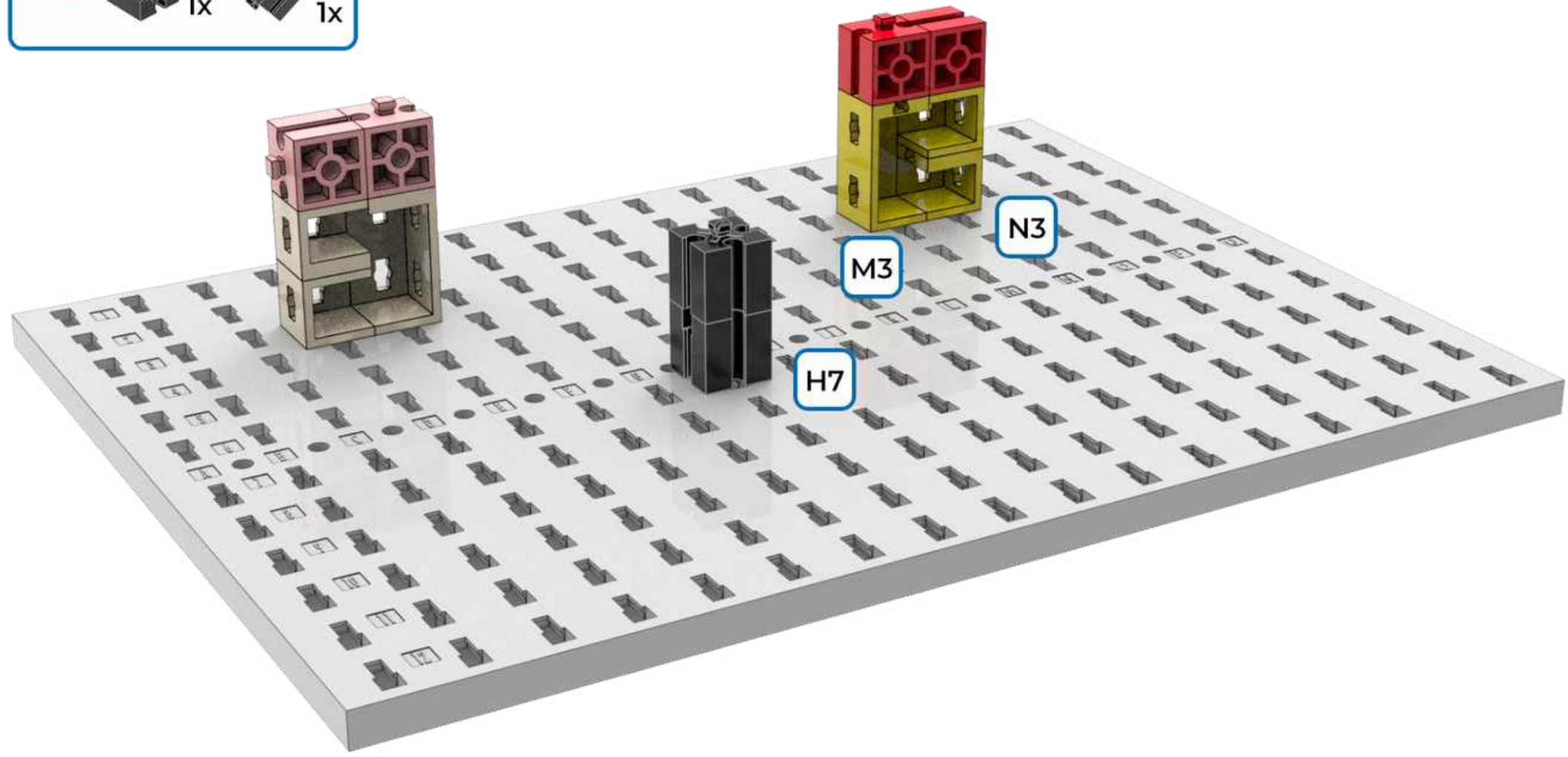
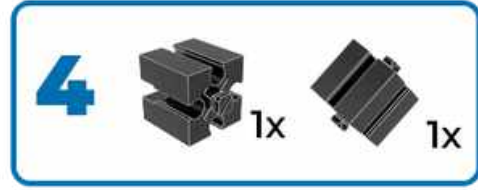
3  2x  1x  1x  1x





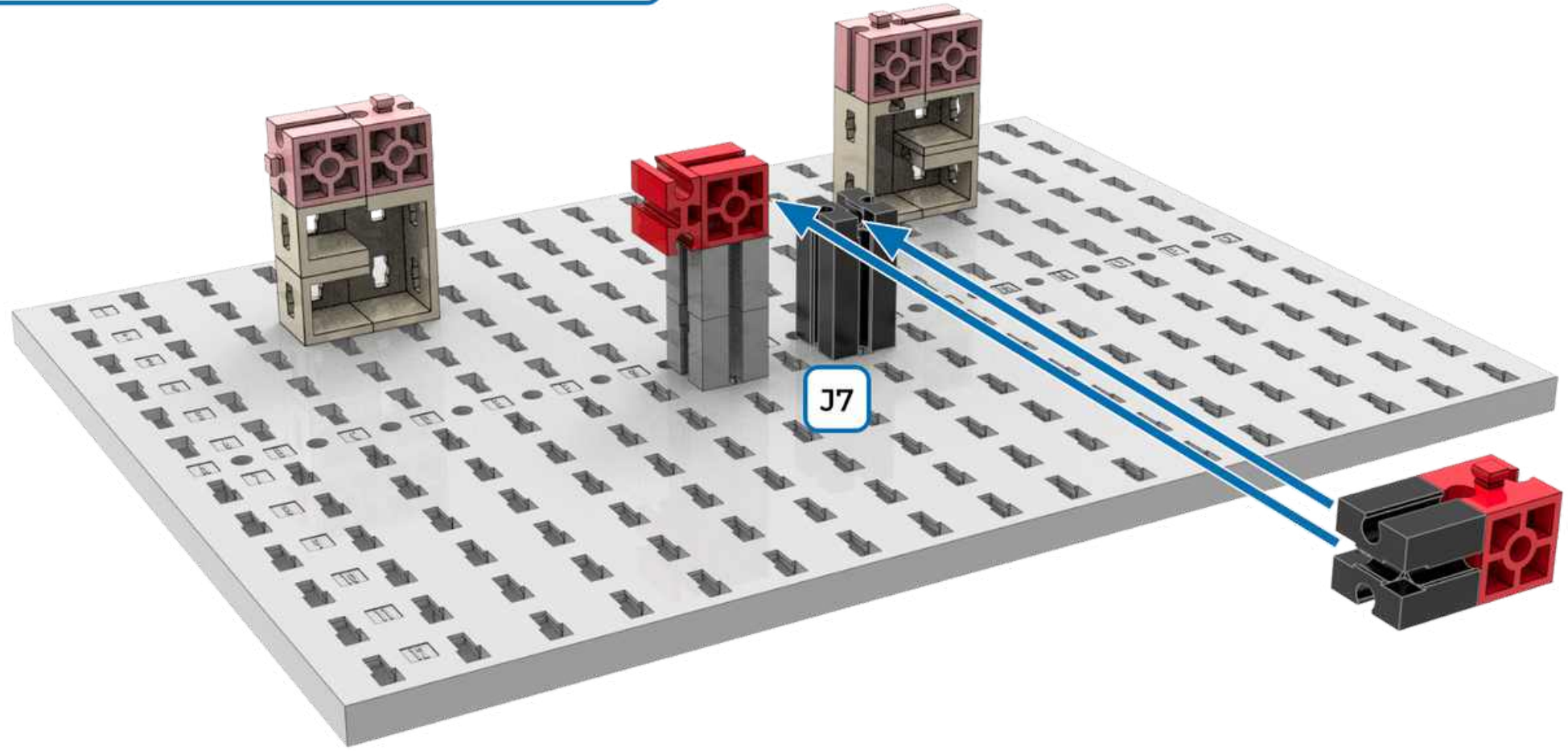

5  1x  1x  2x  1x



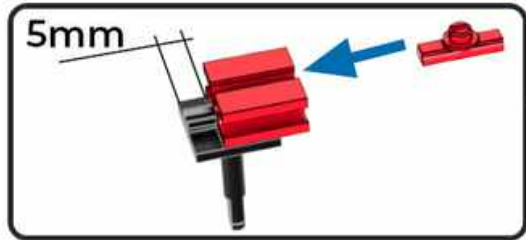
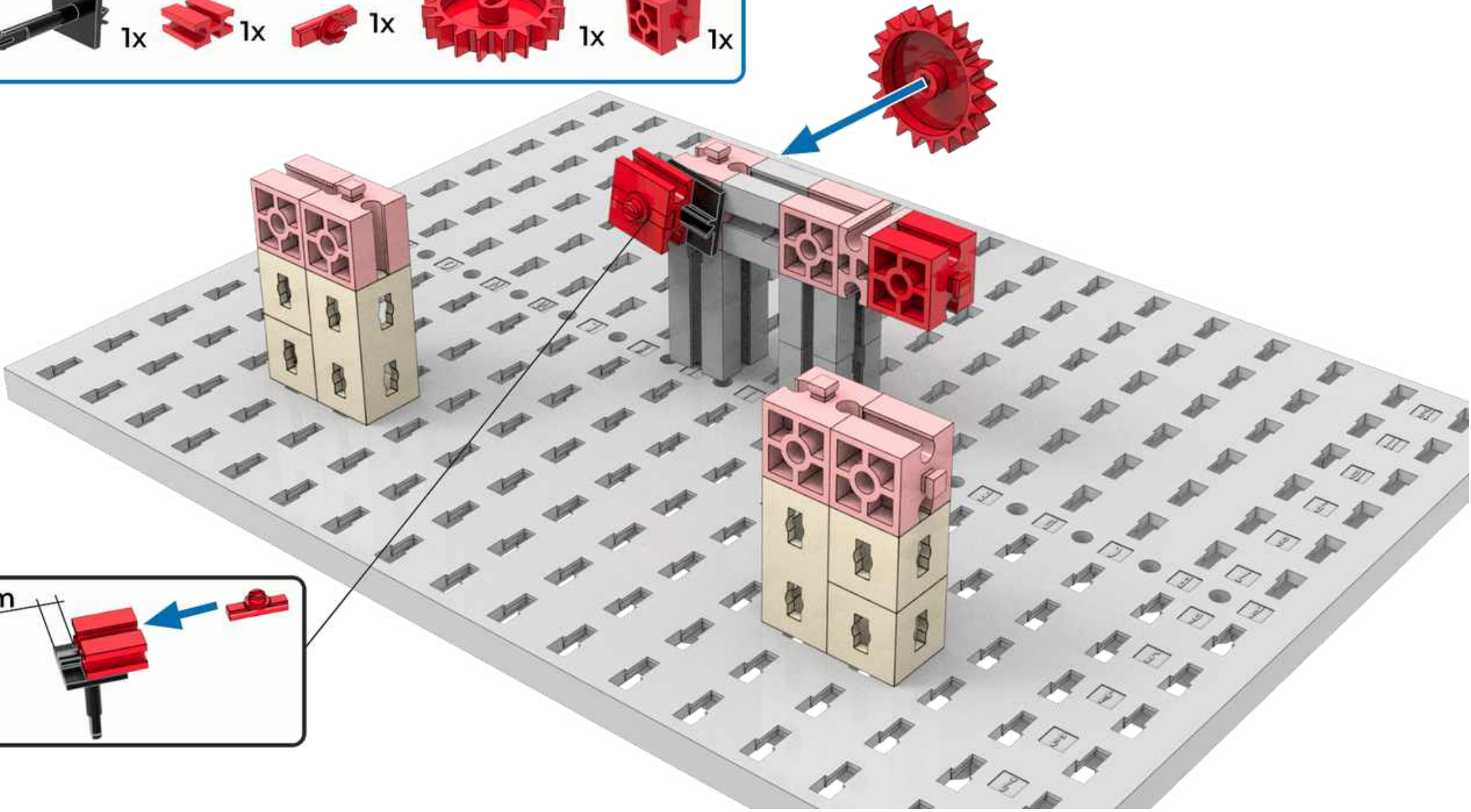



- 6** 1x 1x 1x 1x 1x

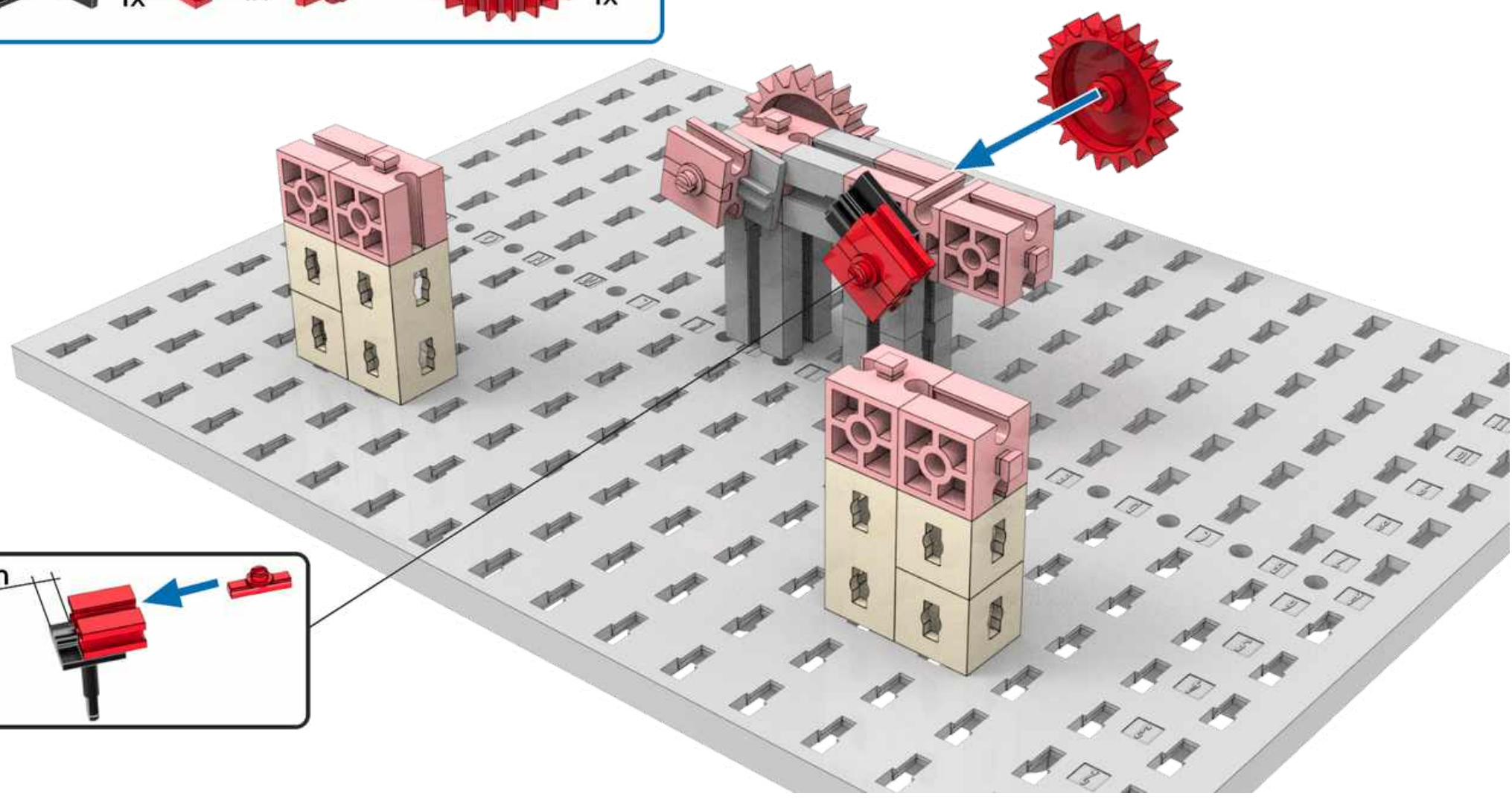

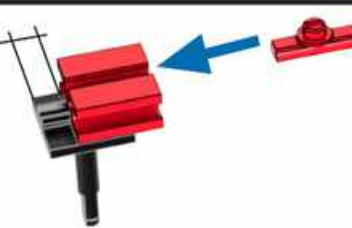
7  1x 1x 1x 1x



5mm 

8  1x  1x  1x

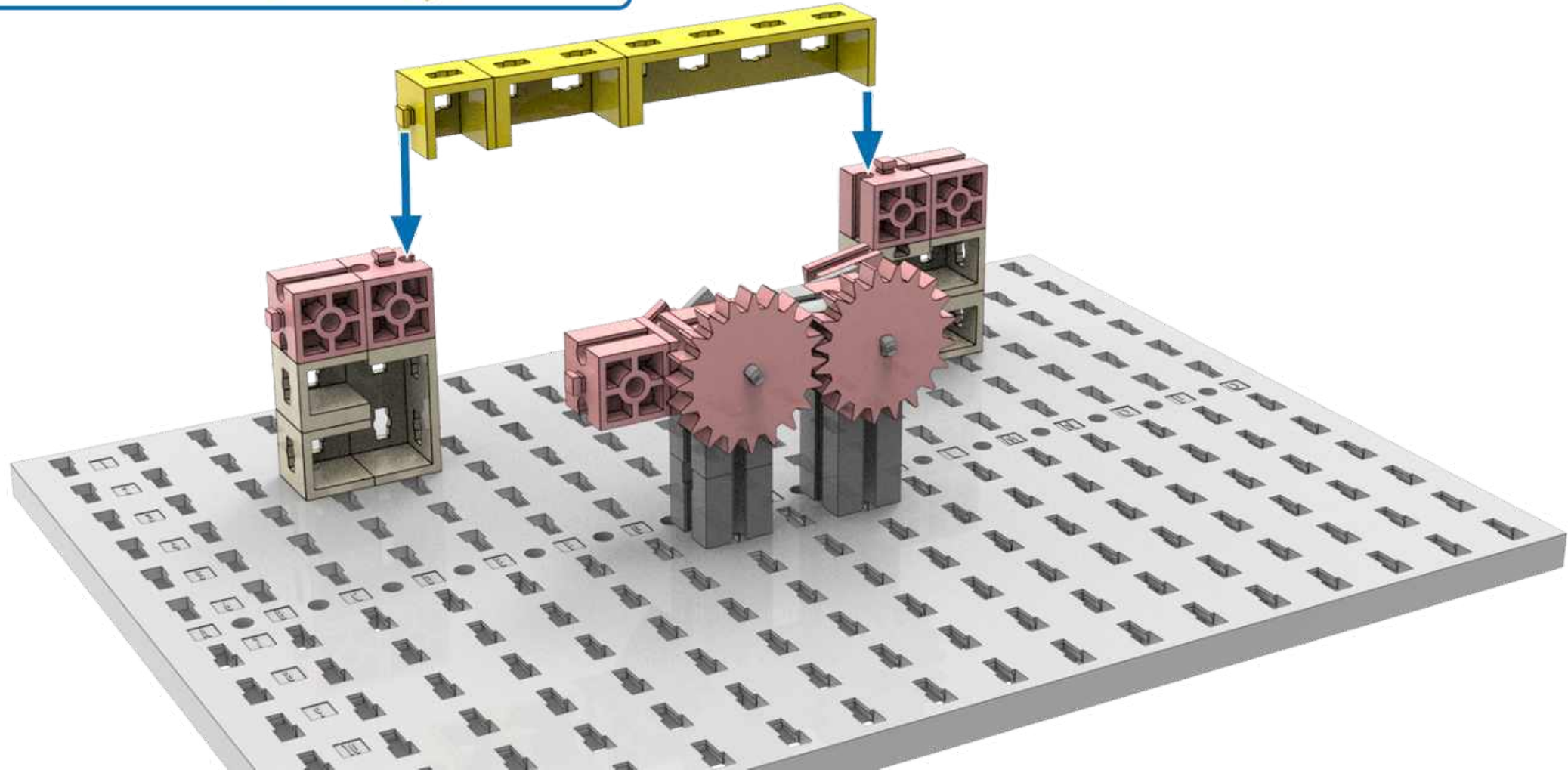

9 90 1x
1x 1x 2x

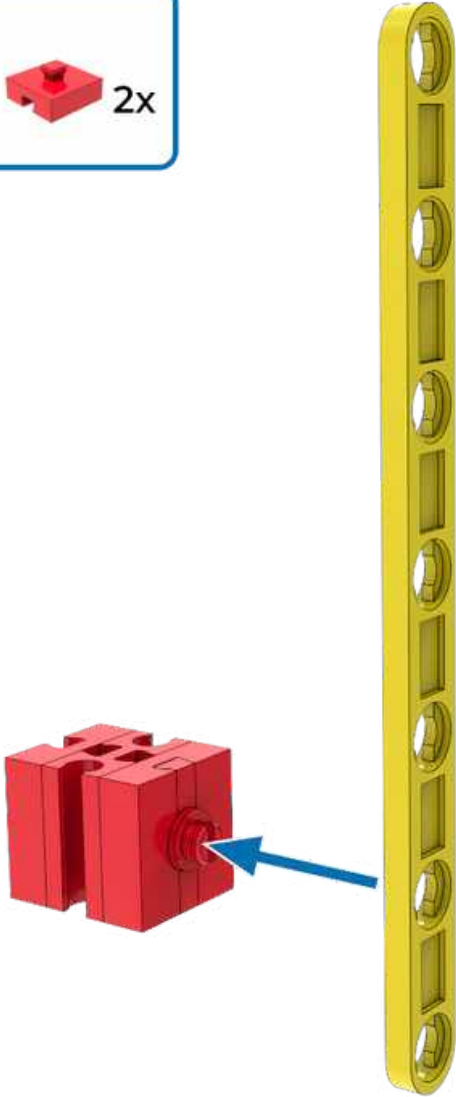
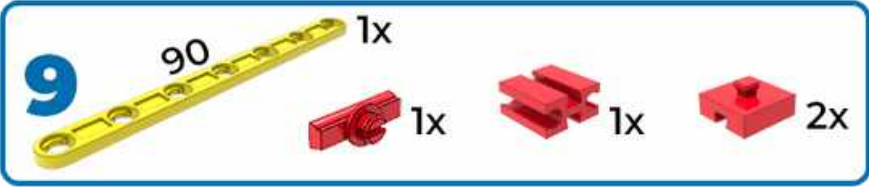

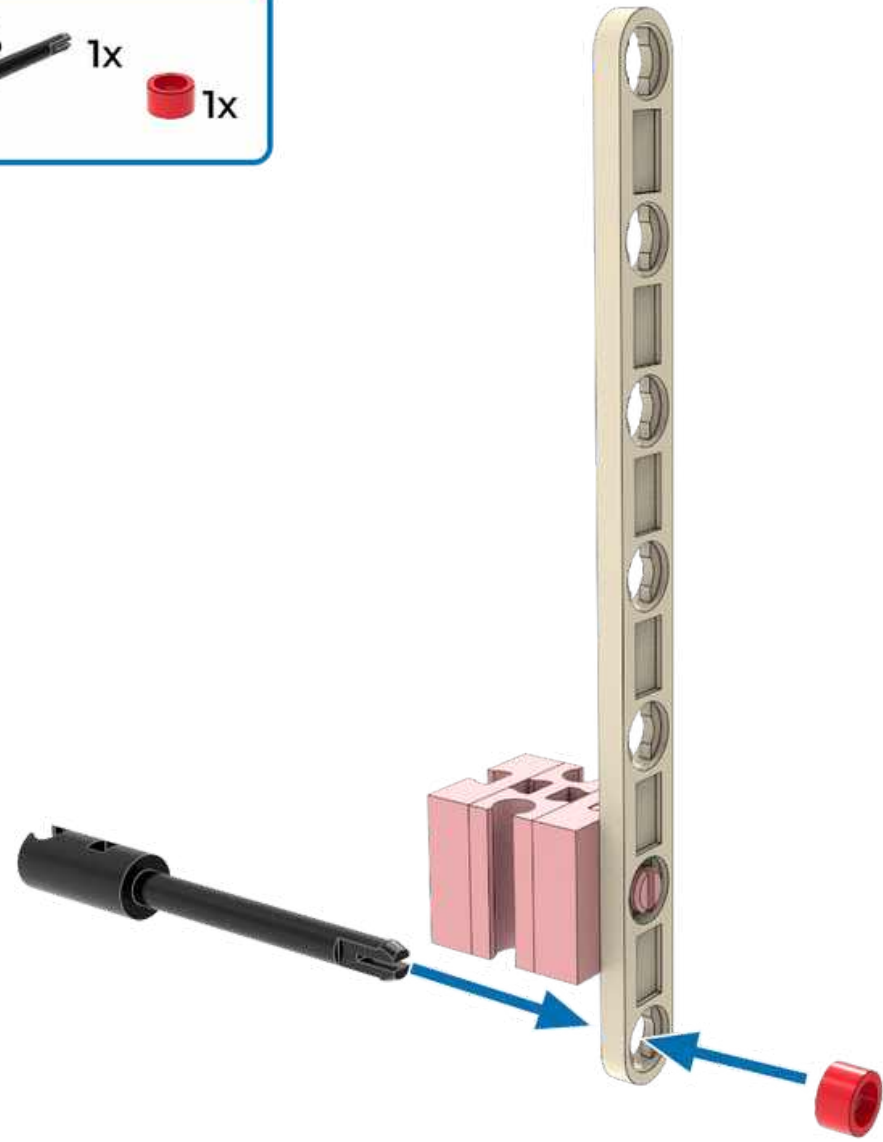

10  1x  1x  1x

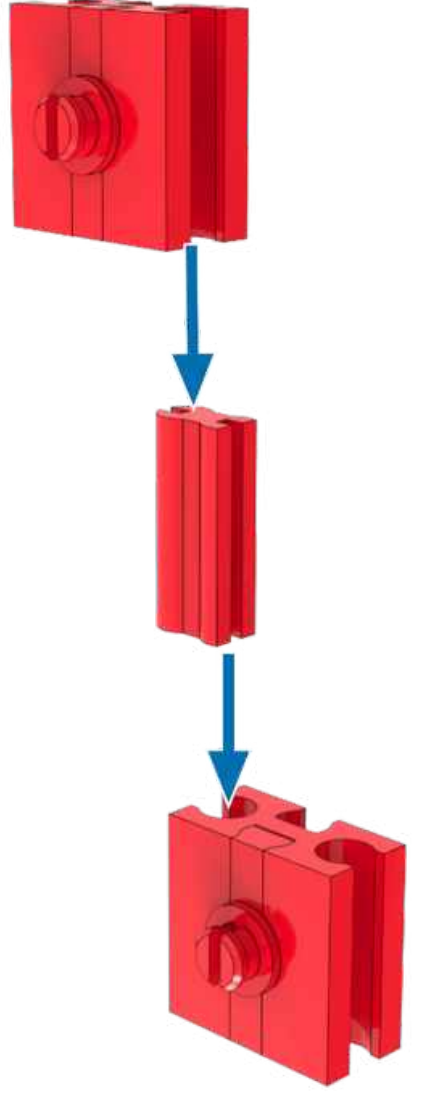

11  1x  2x  2x

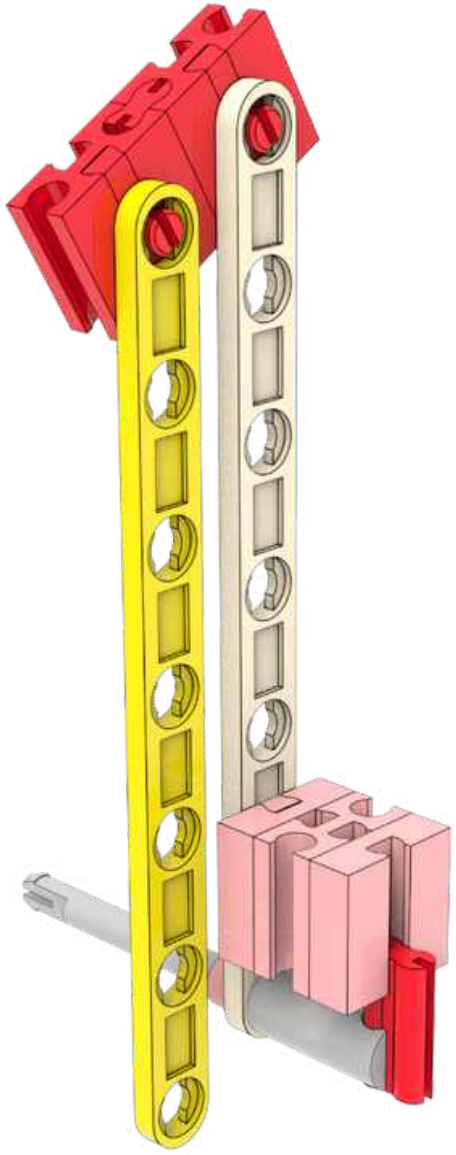

12 ¹⁵ 1x ⁹⁰ 1x



13 30 1x 1x 1x 1x

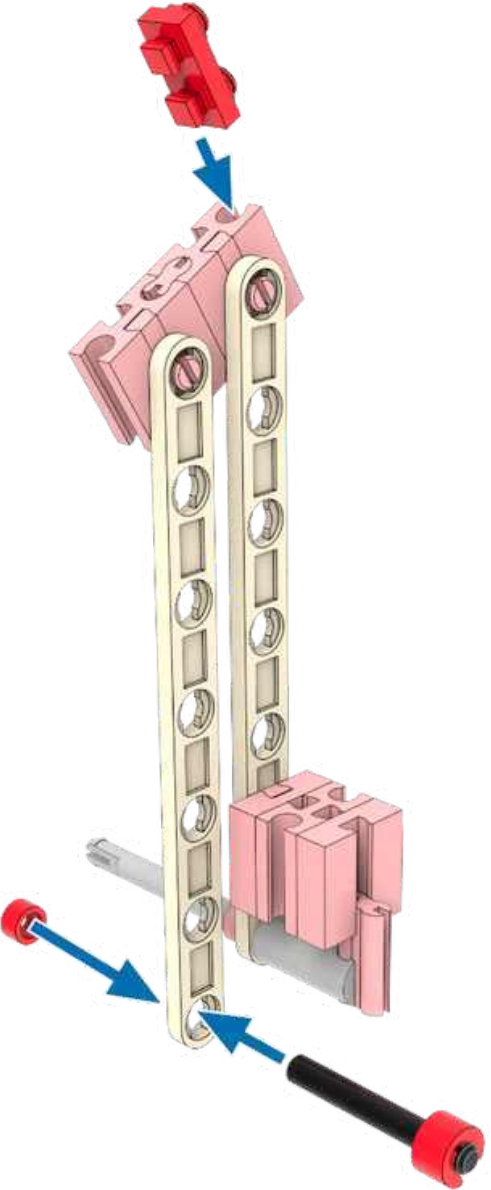
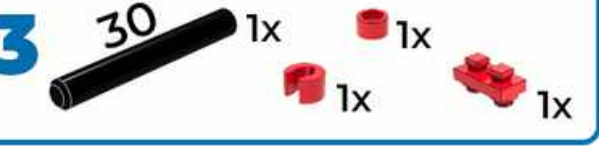

14  2x

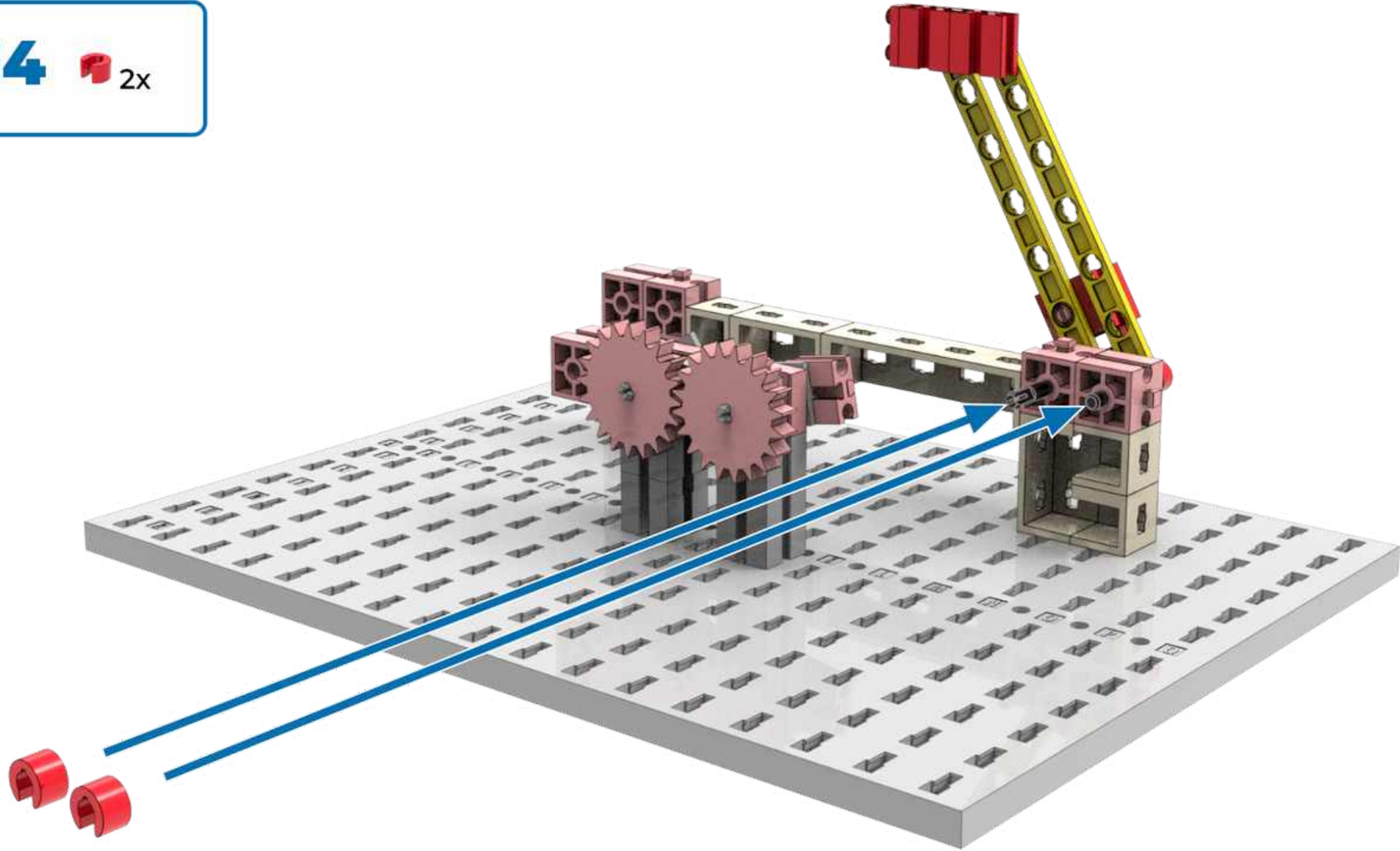

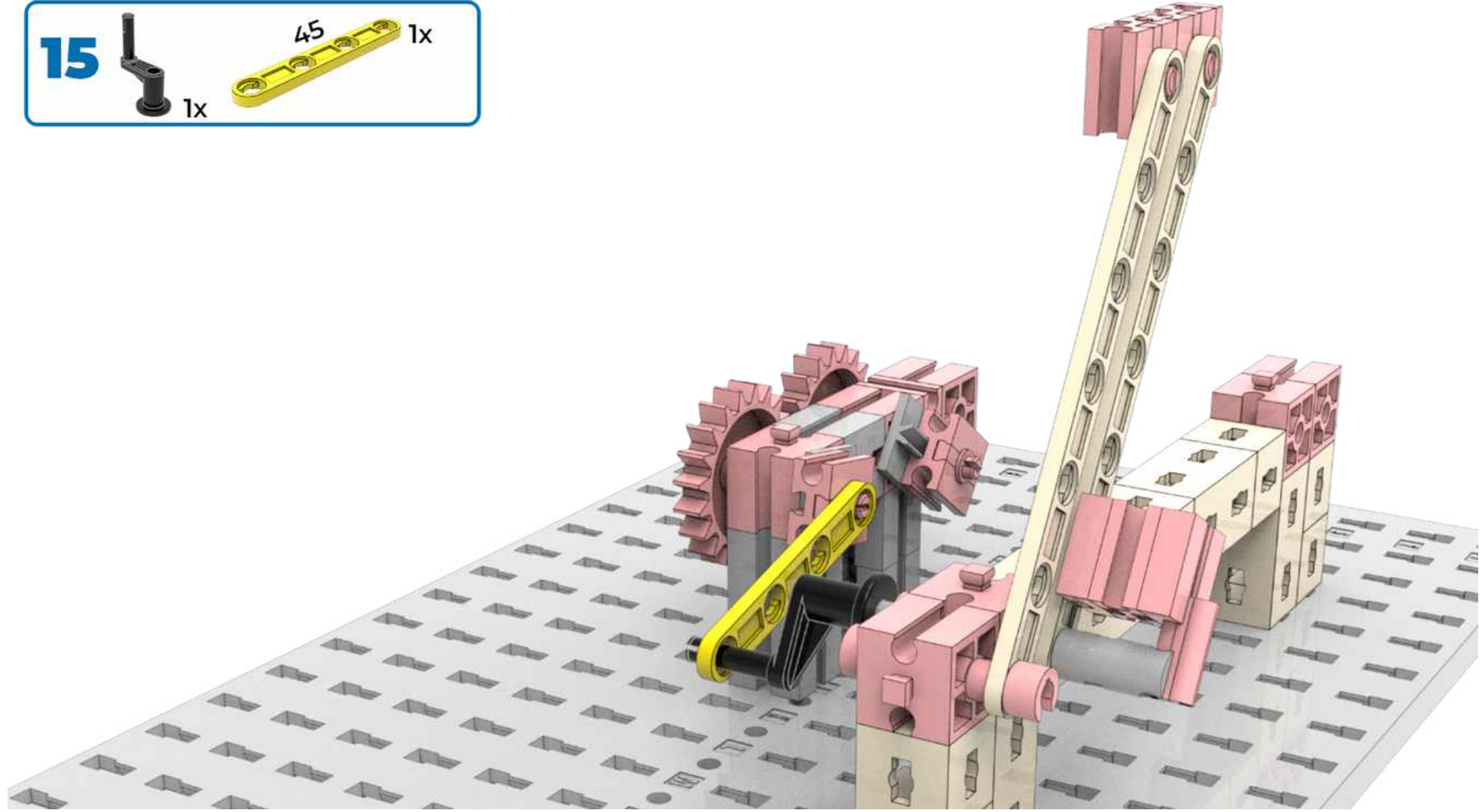
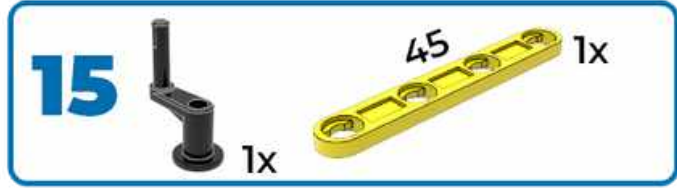

16 4x2,4 2x 120 1x 4 2x

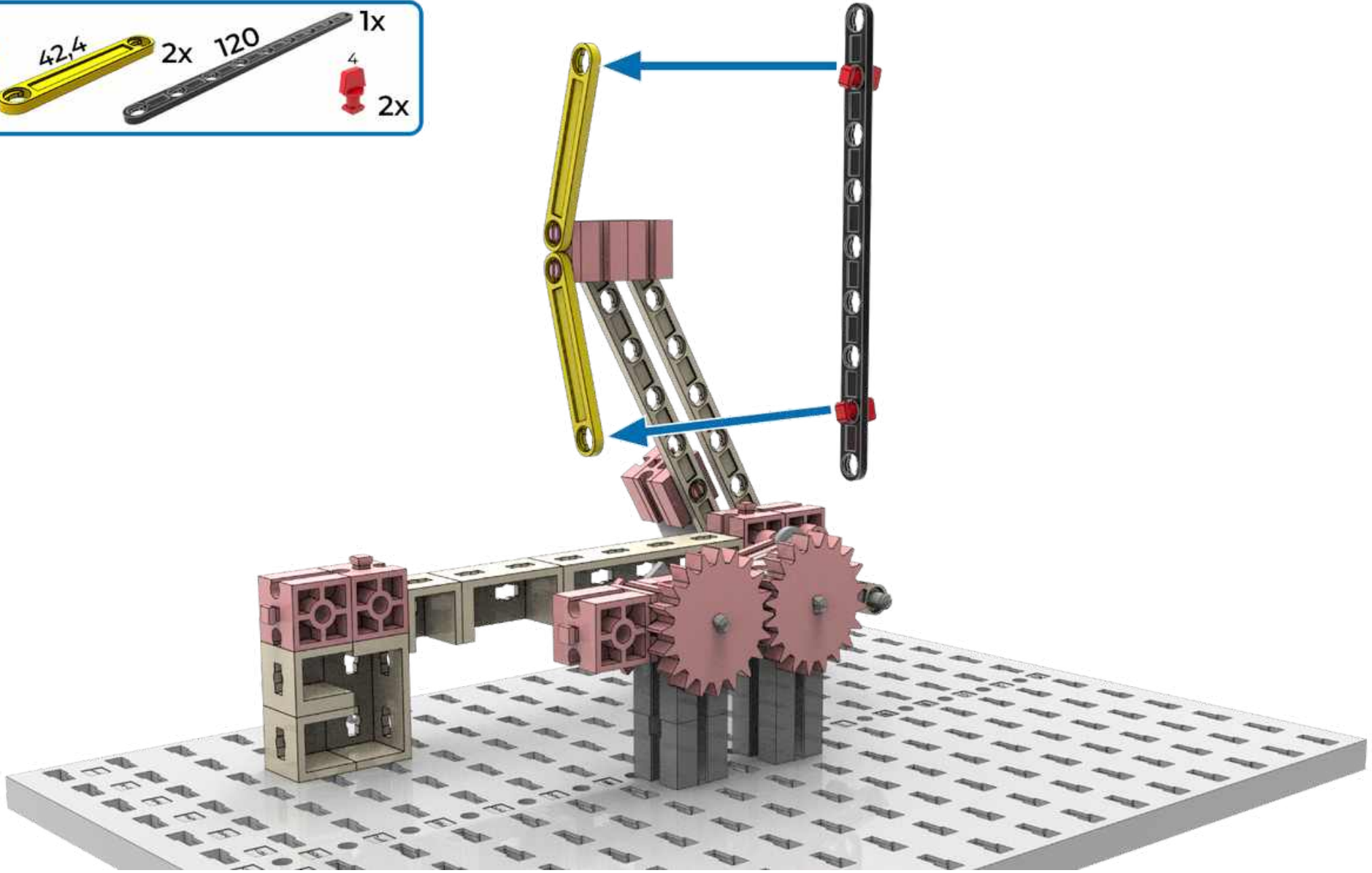

17 90 1x
1x 1x 2x

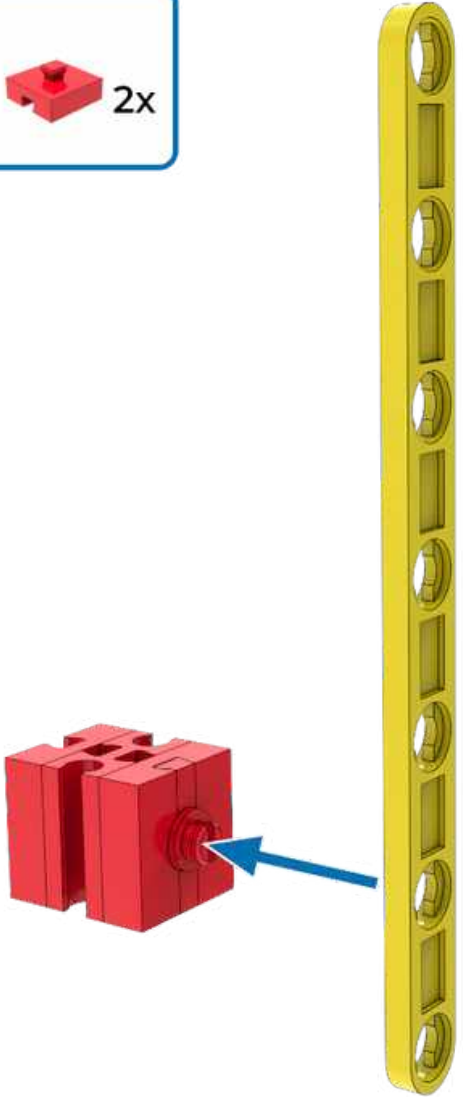
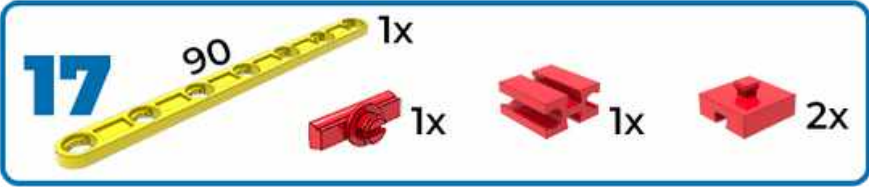

18  1x  1x  1x

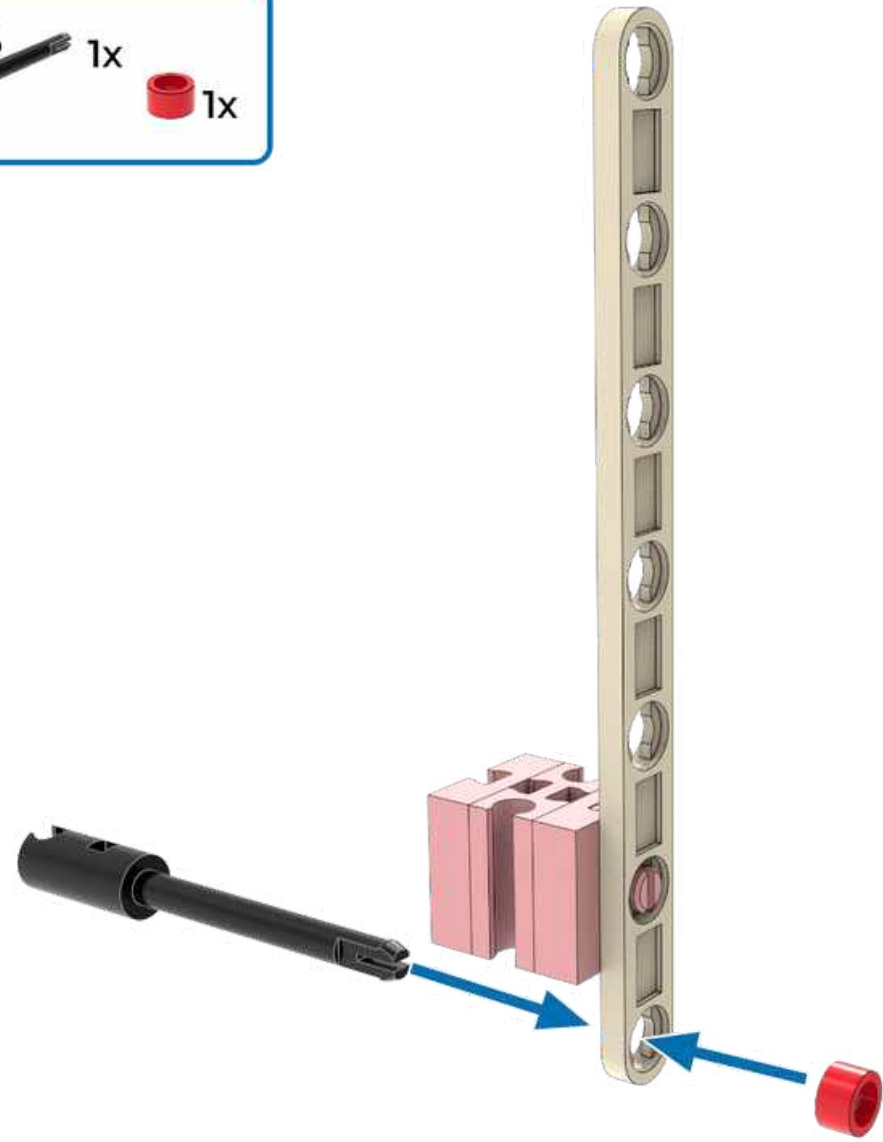

19  ¹⁵ 1x  2x  2x

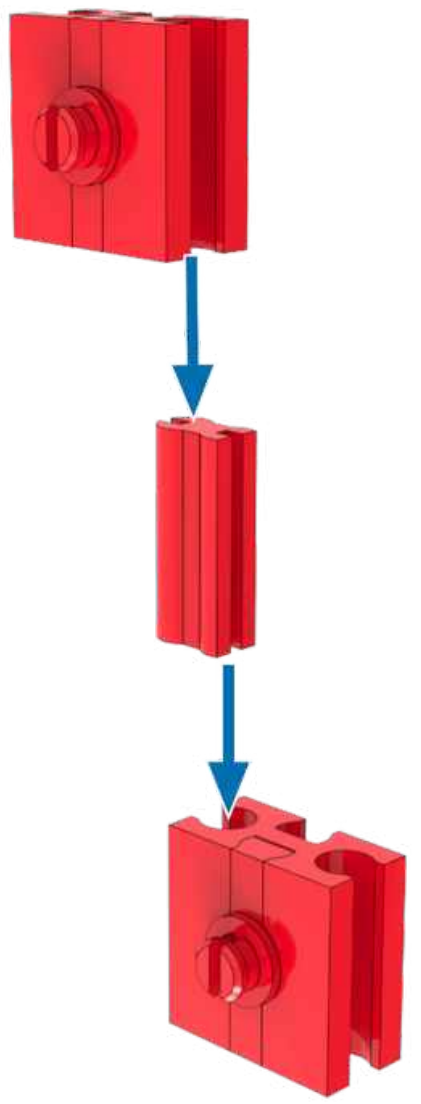

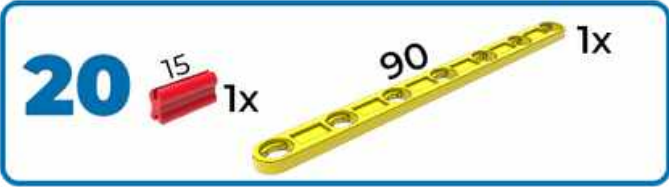



21 30 1x 1x 1x 1x

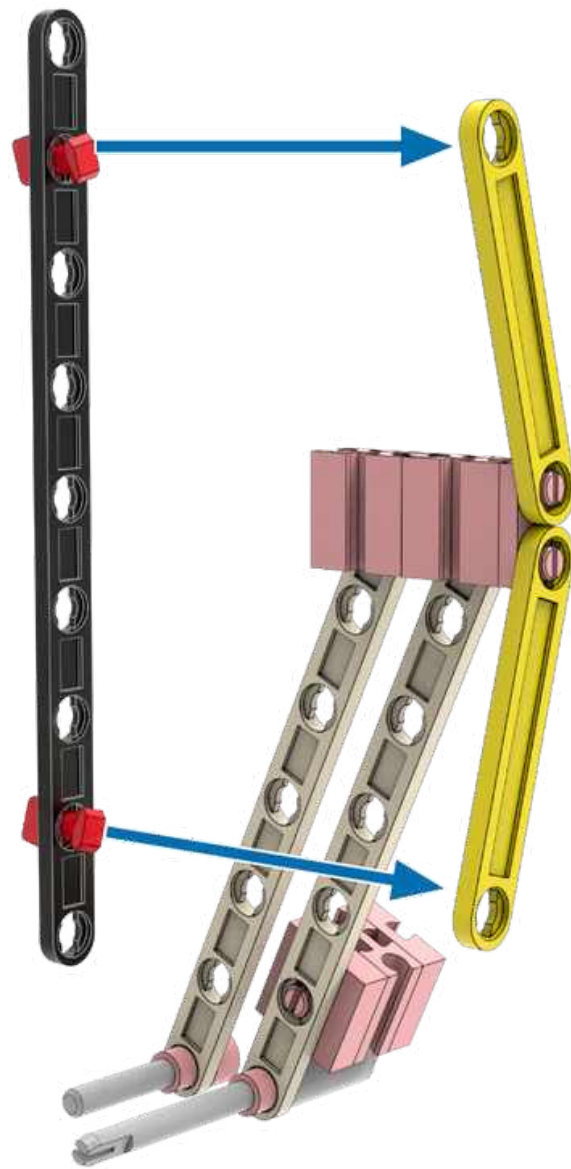



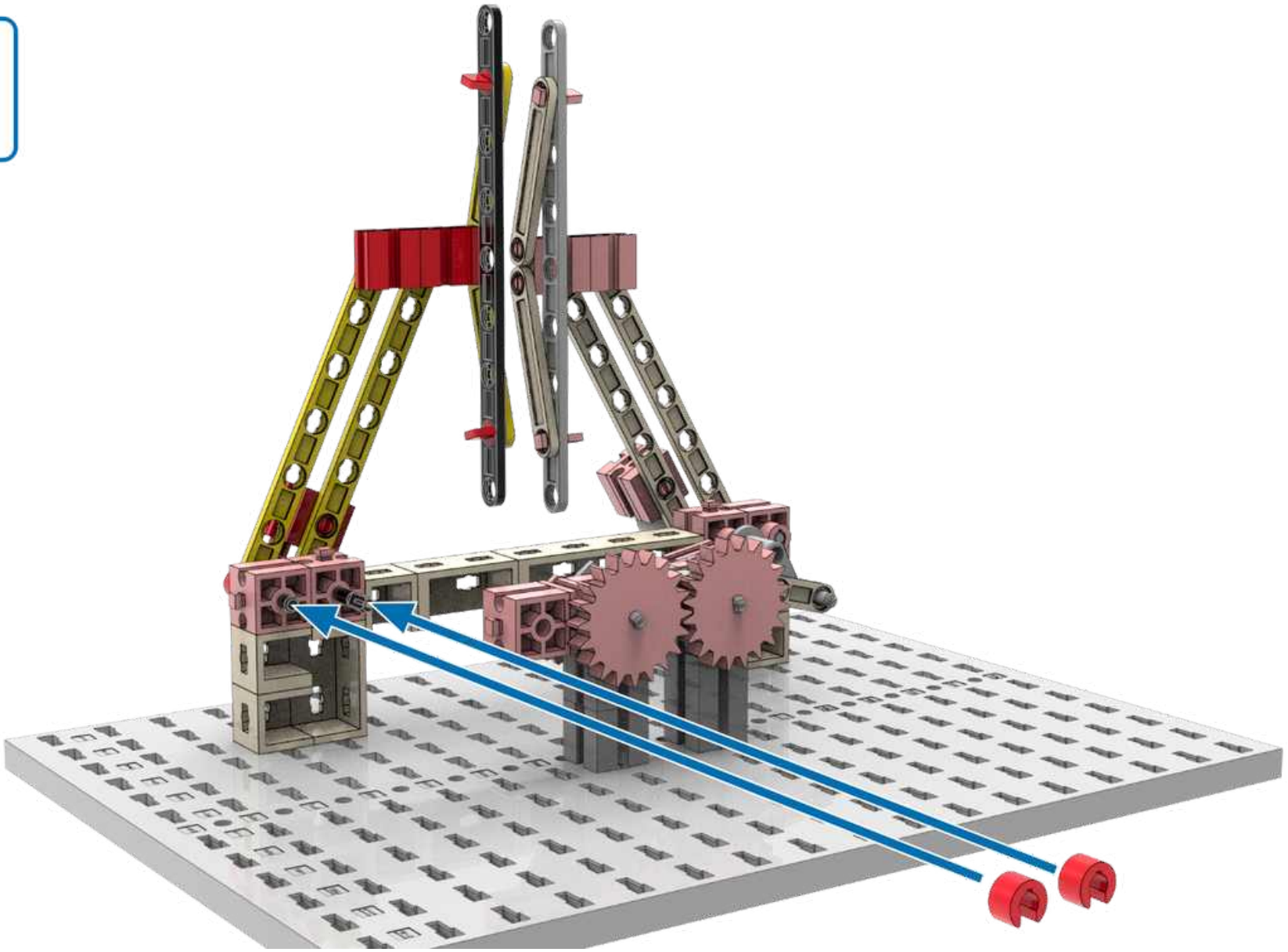



23  2x

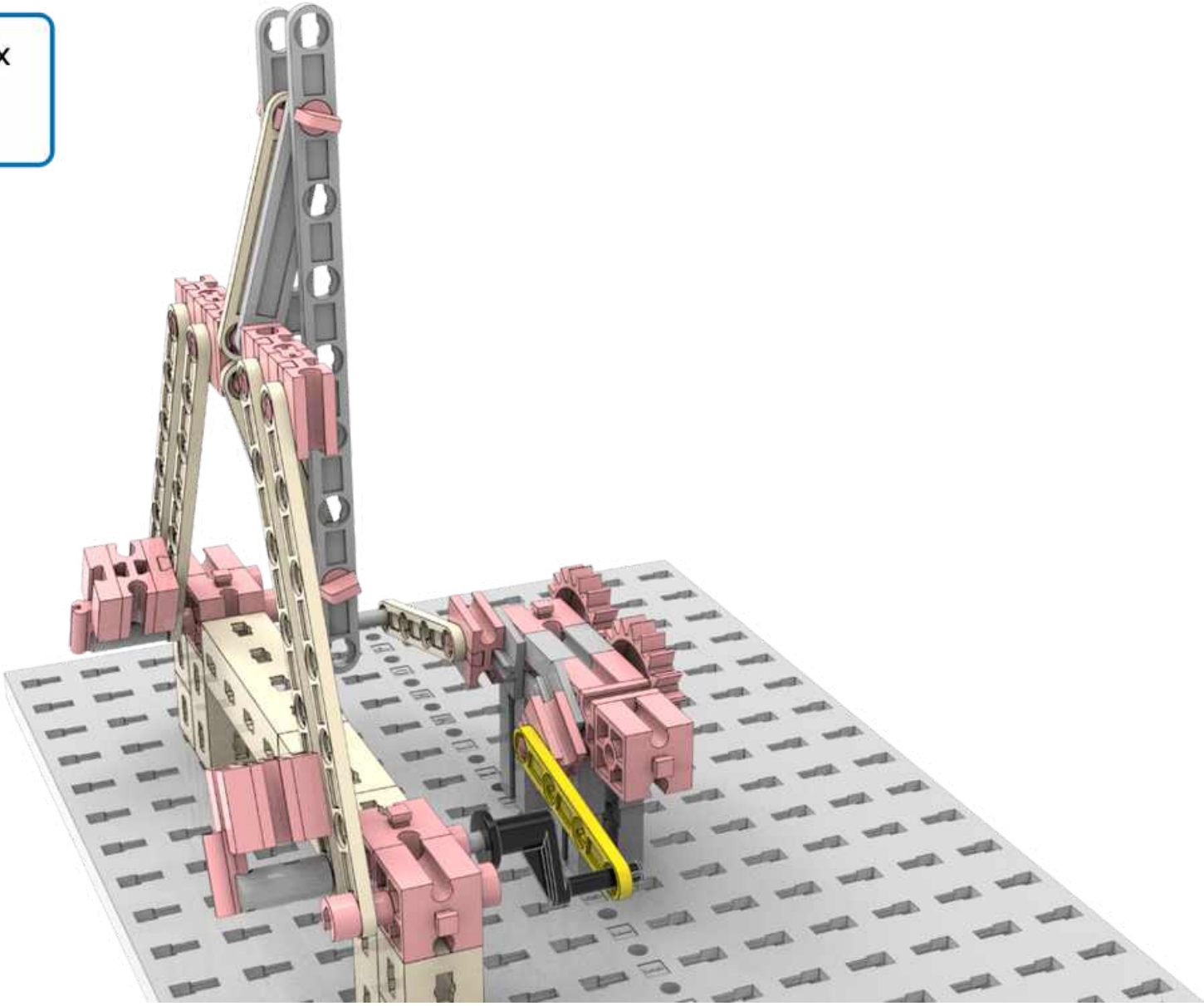



24  1x  45 1x

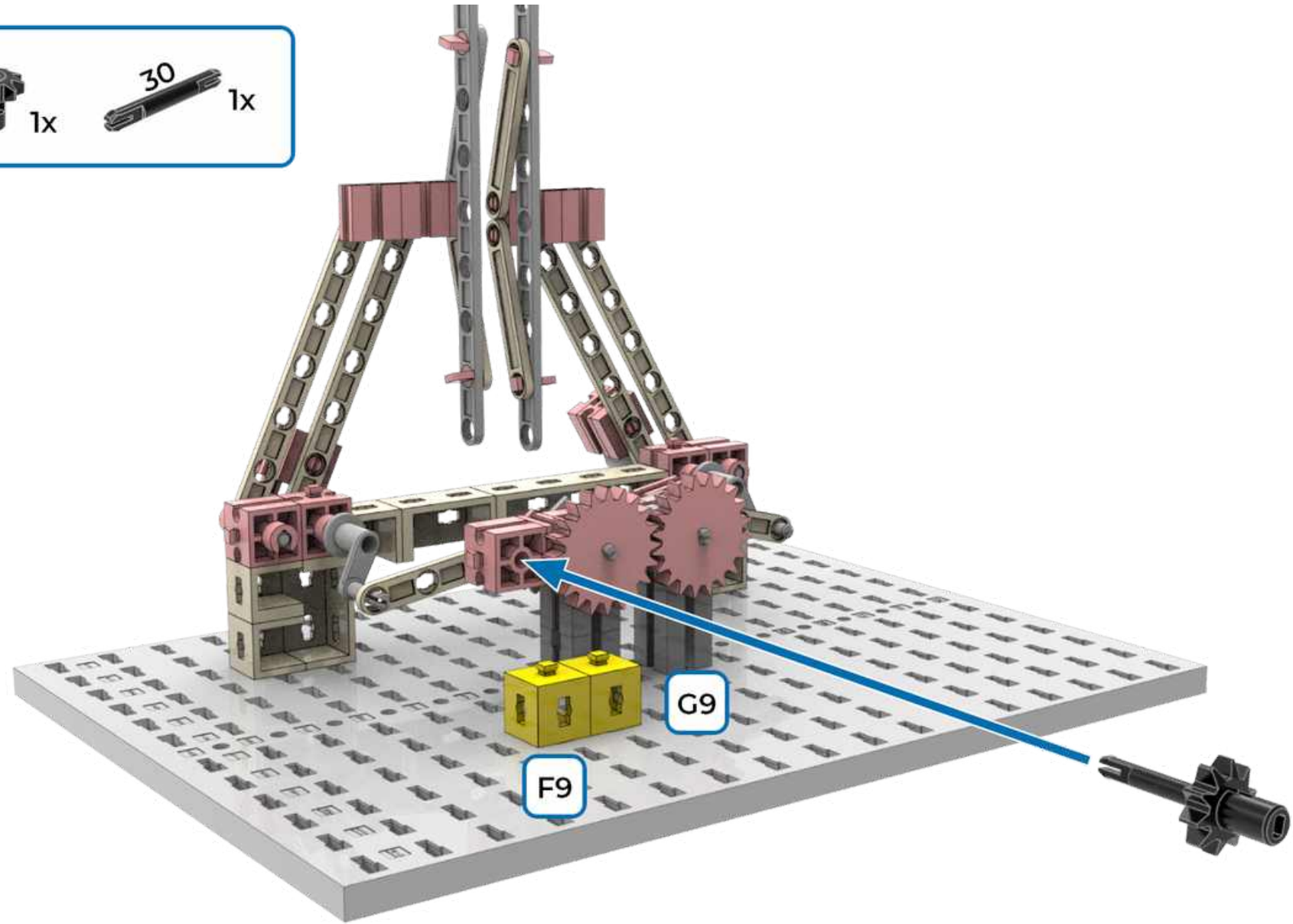

25  1x  1x  30 1x



26  2x  3x

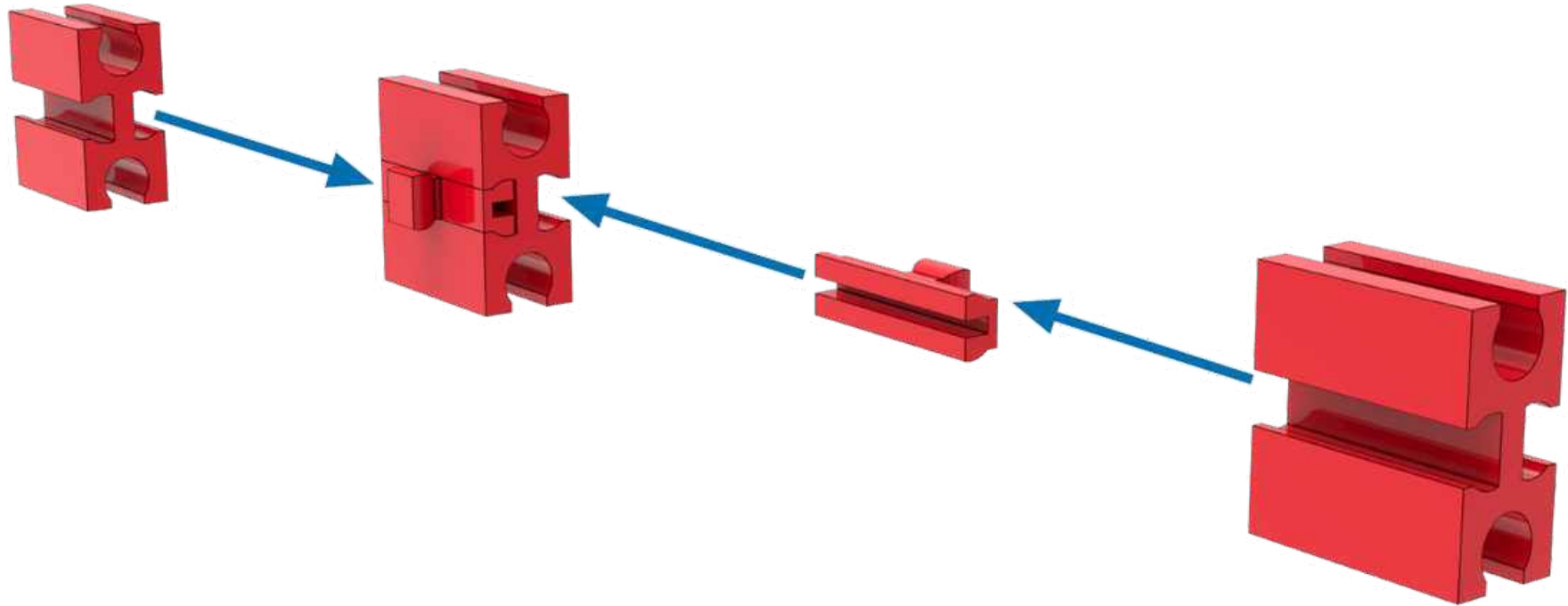

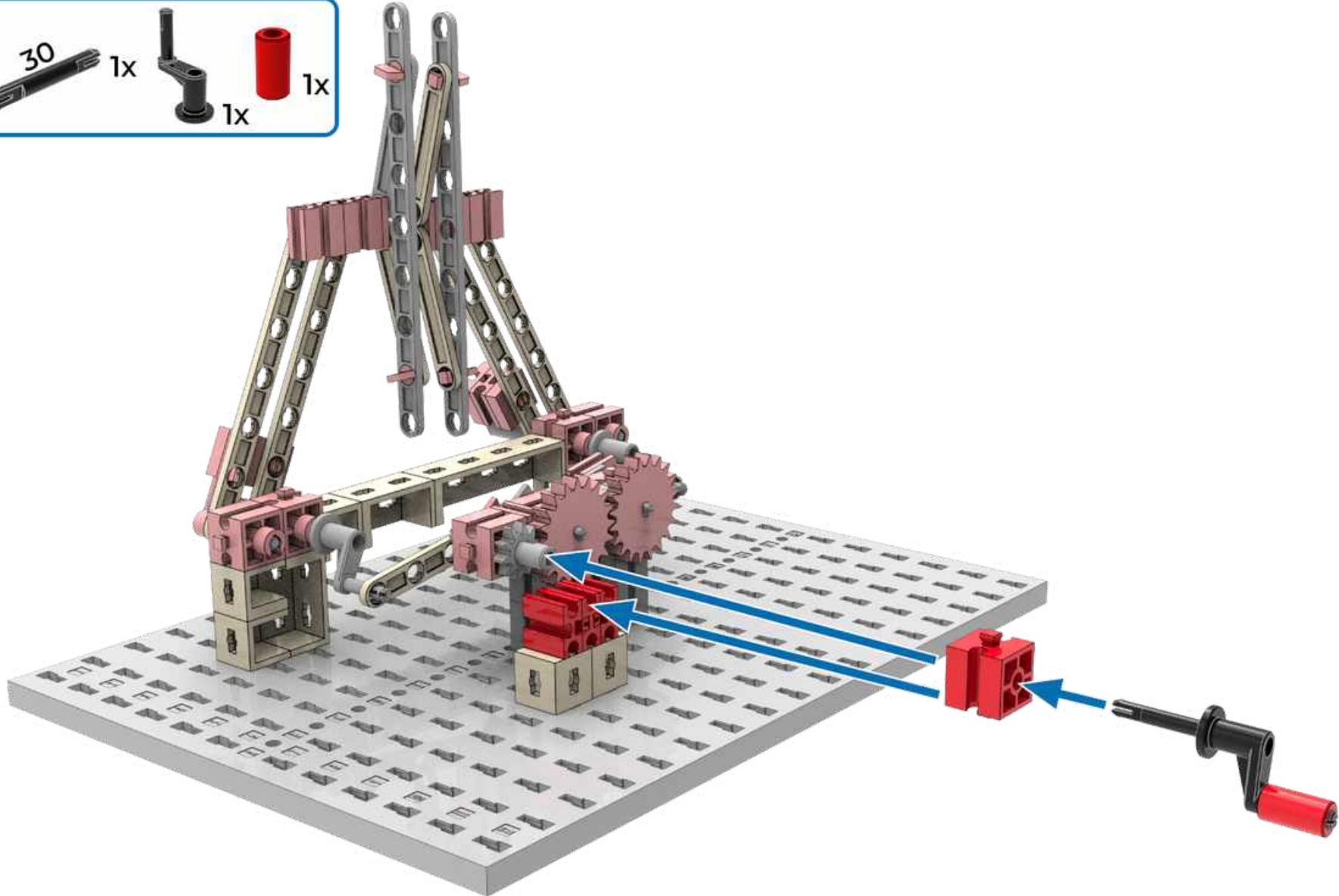

27  1x  1x  1x  1x





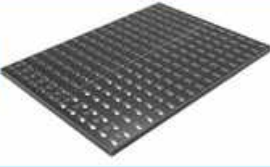

Scheibenwischer gleichläufig



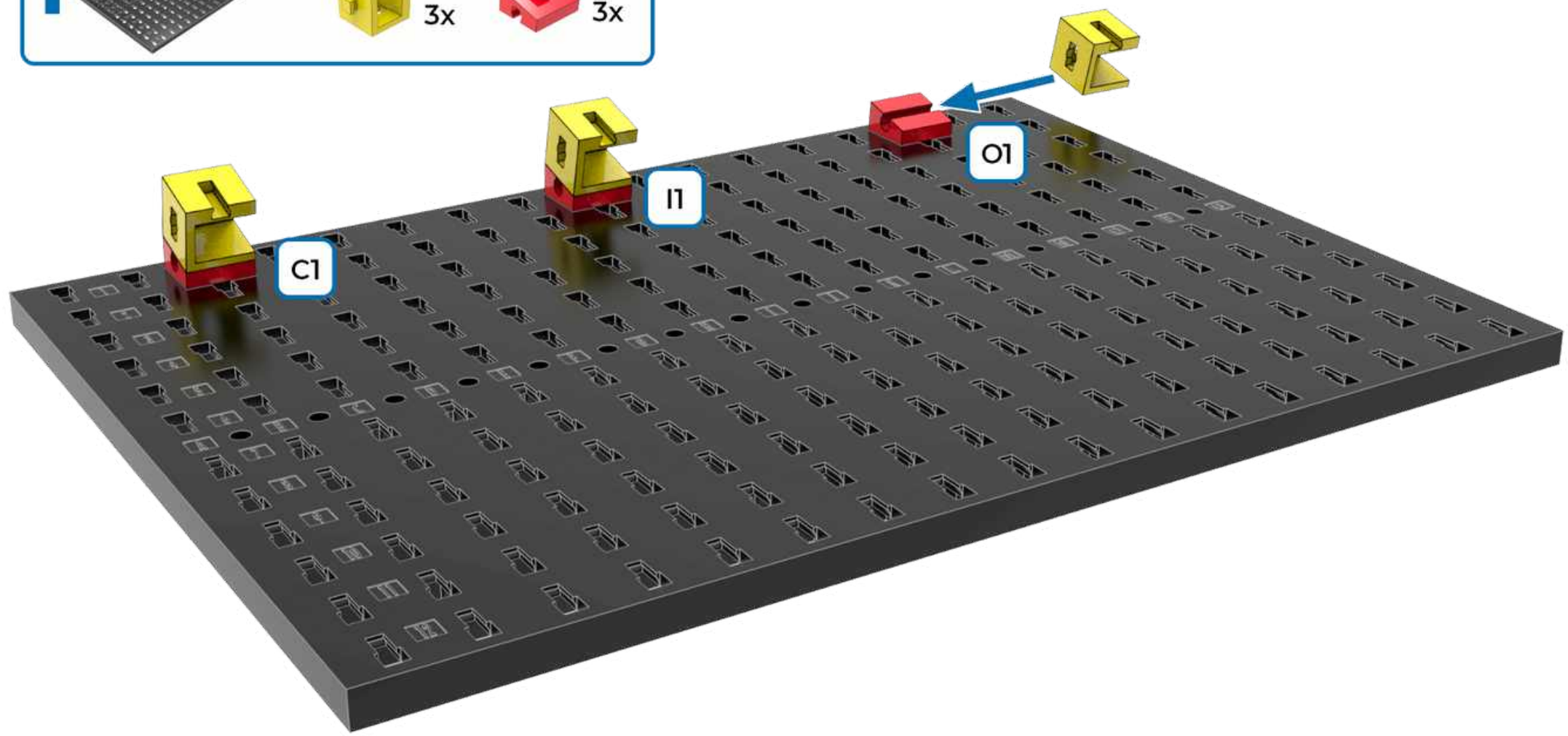





1  1x  3x  15° 3x

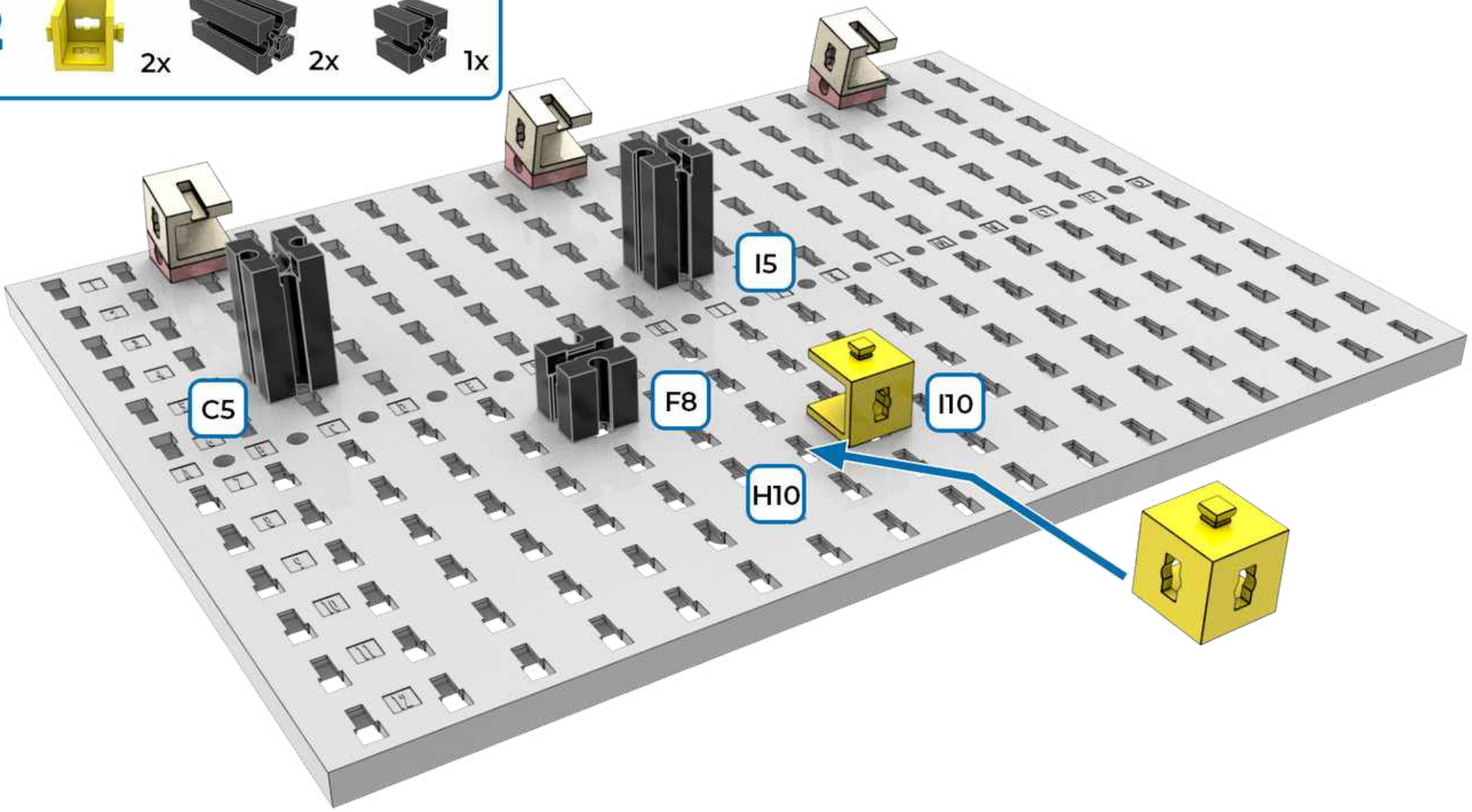



2  2x  2x  1x

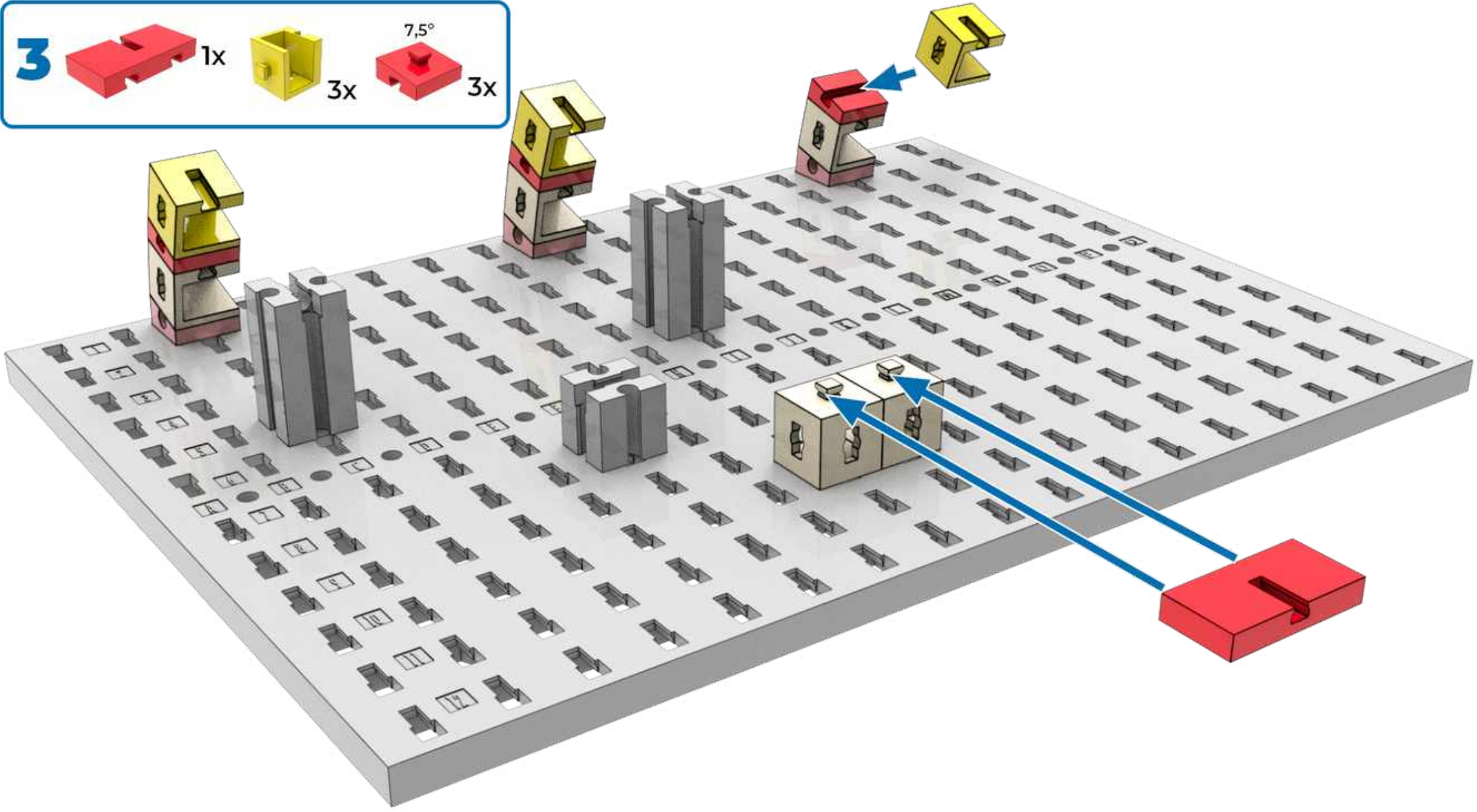

3  1x  3x  7,5° 3x



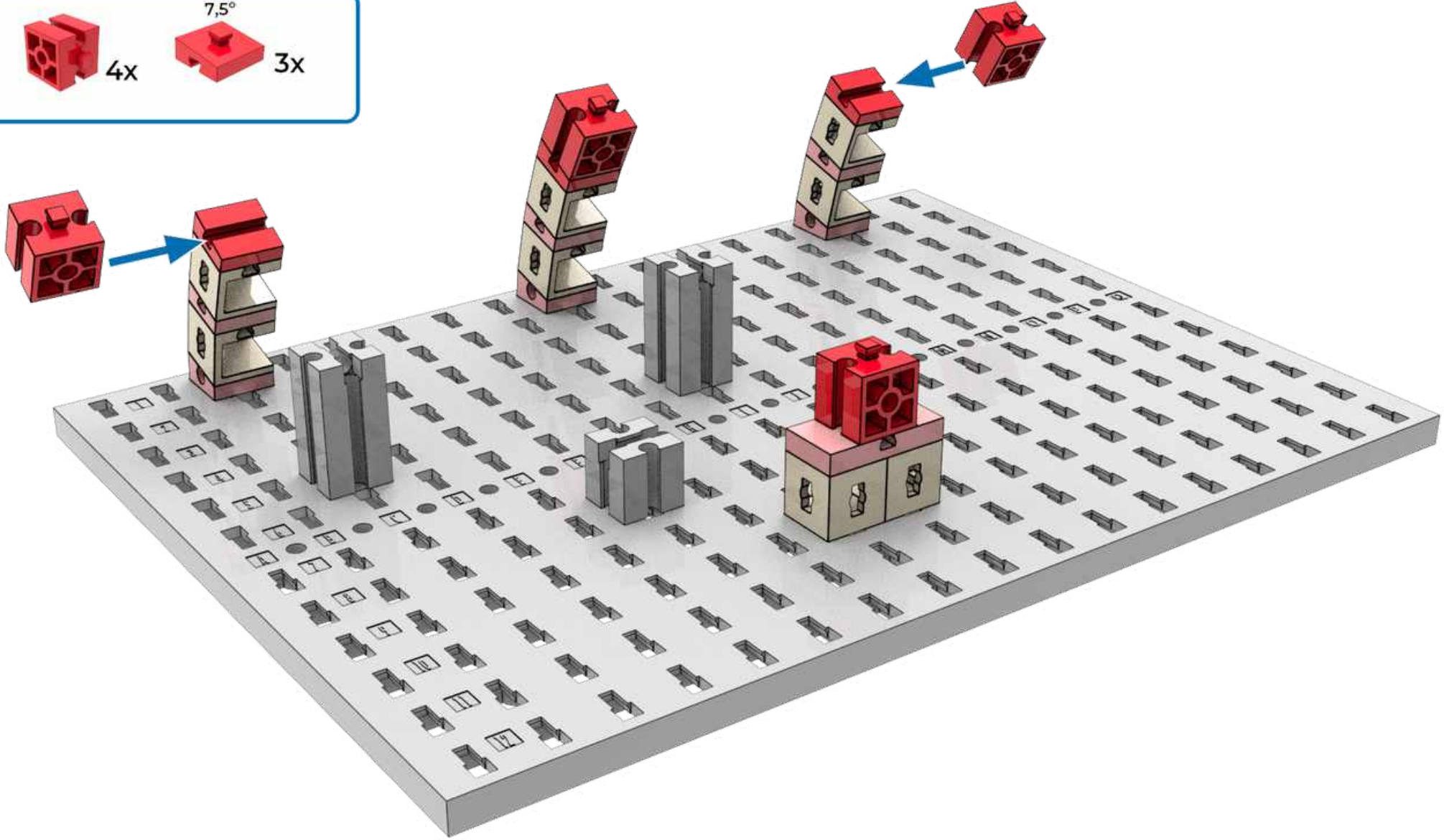

4  4x  7,5° 3x

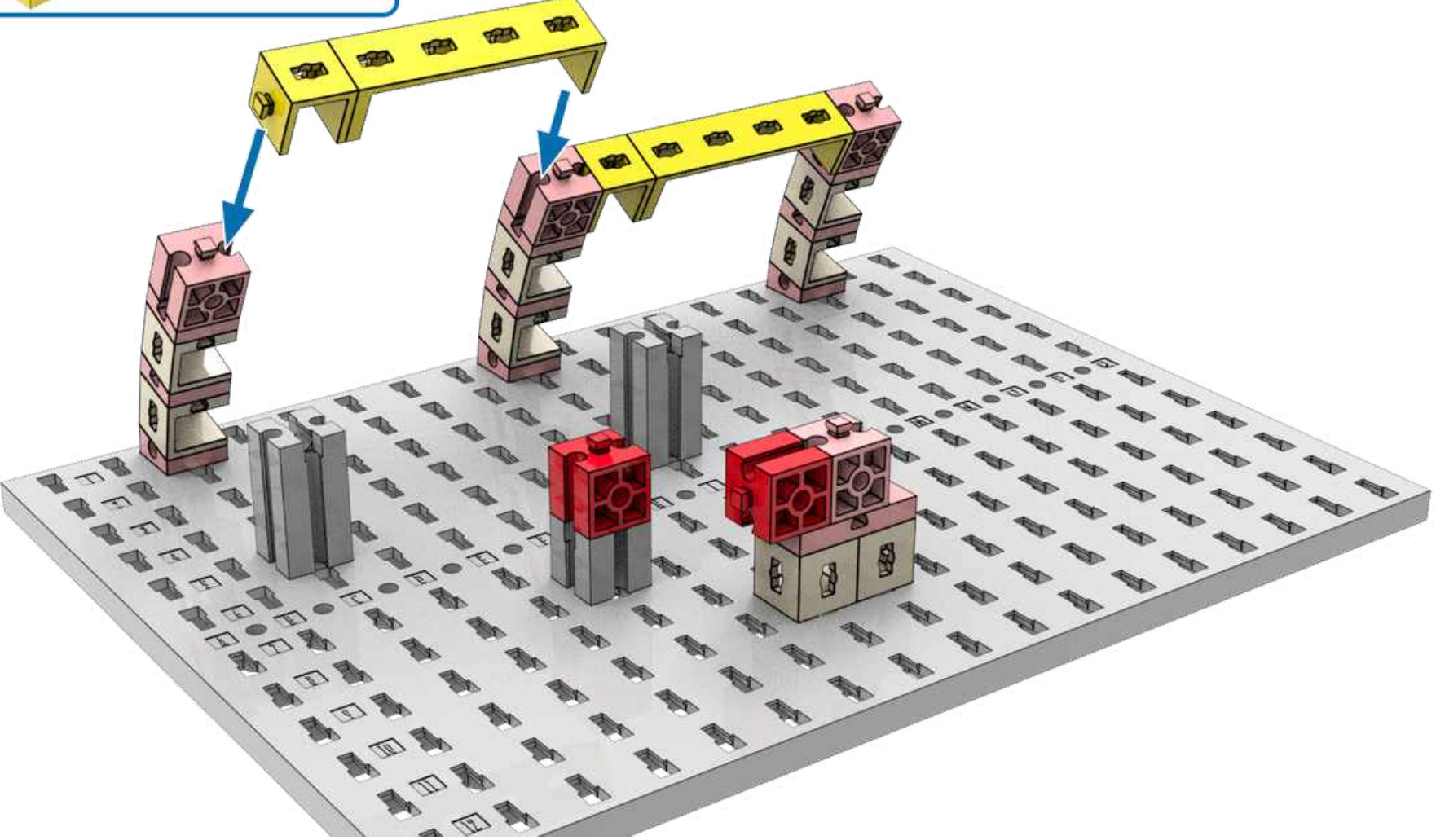

5  2x  2x  2x







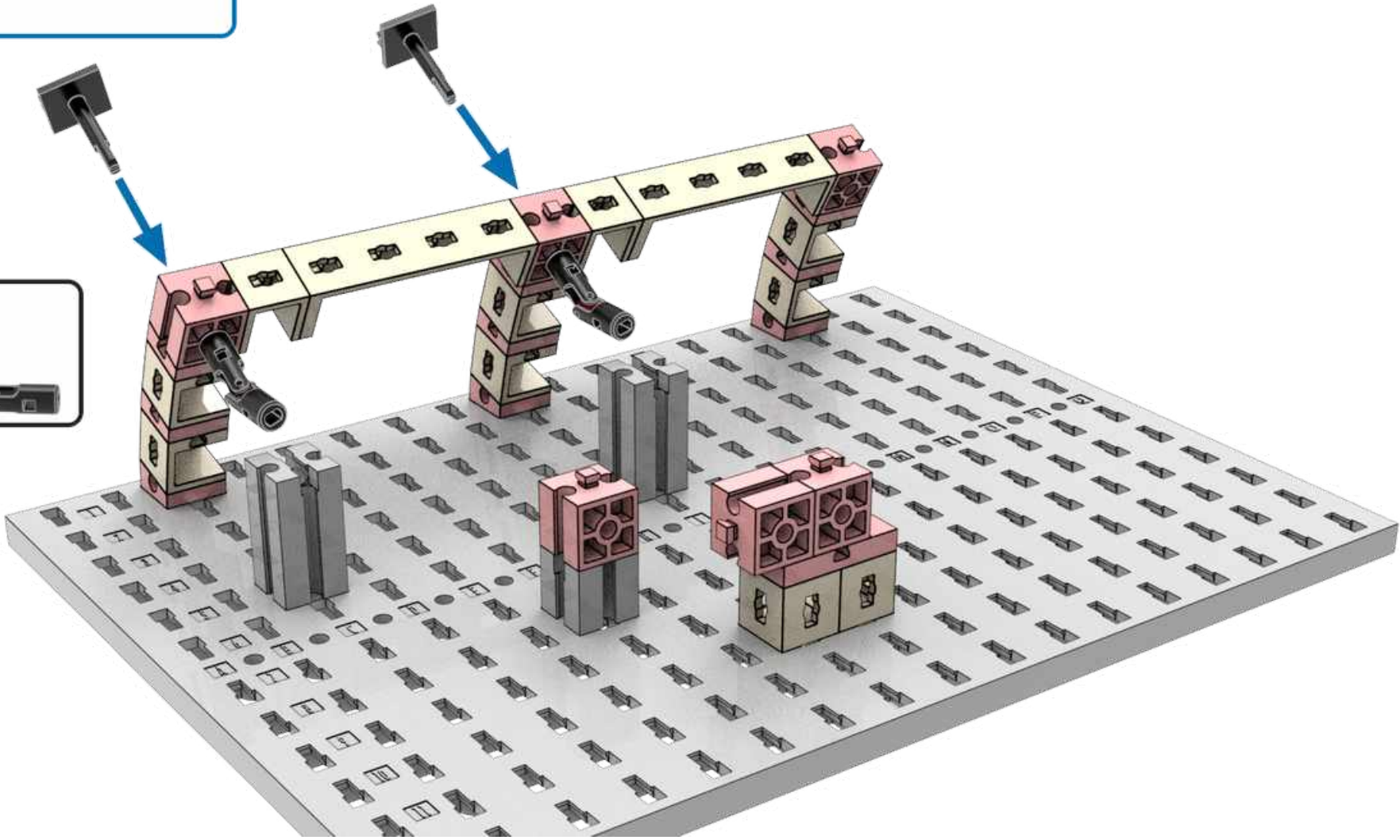

6  2x  4x  2x

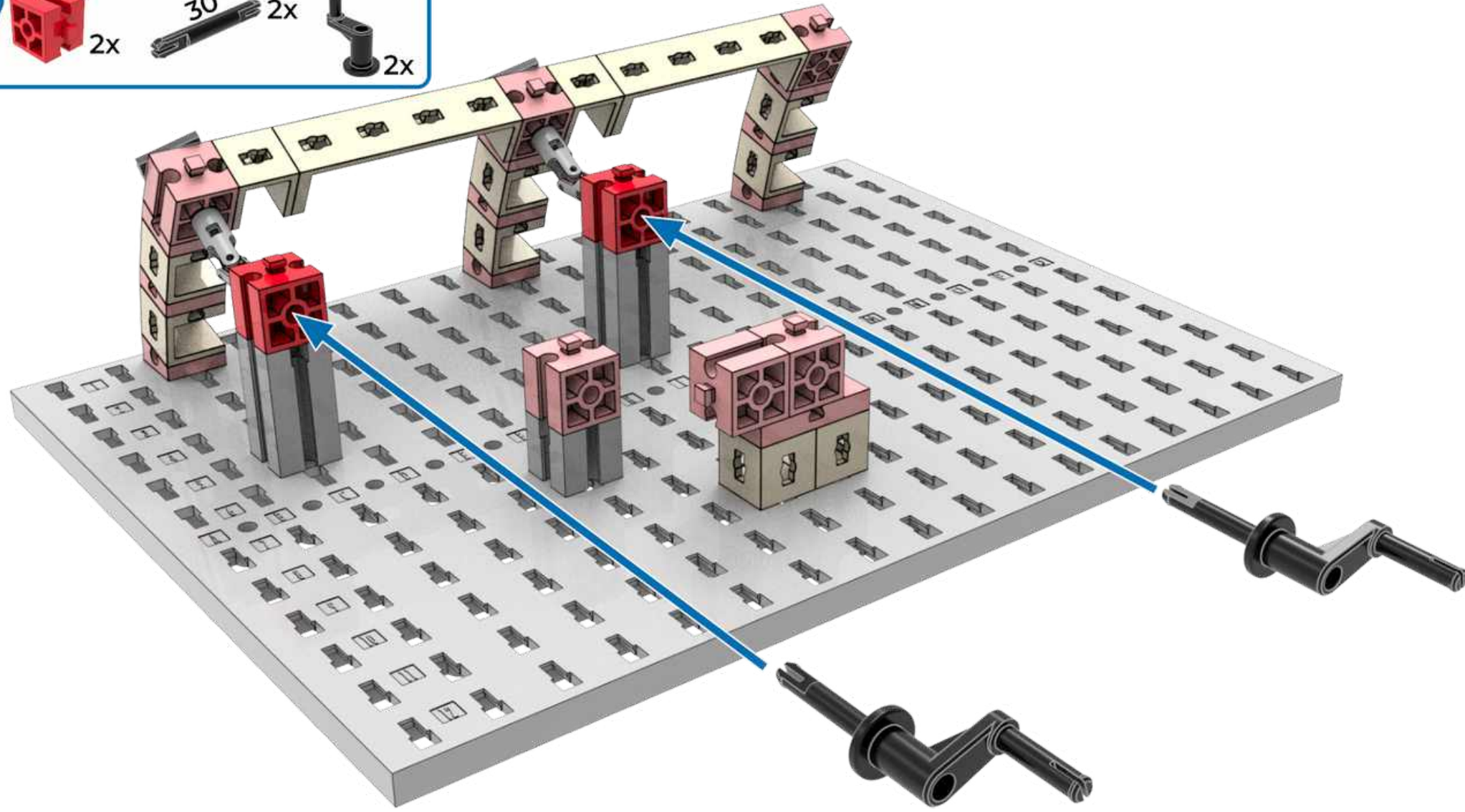
  2x 



7  2x  2x  2x



- 8  2x  1x  1x  1x  1x

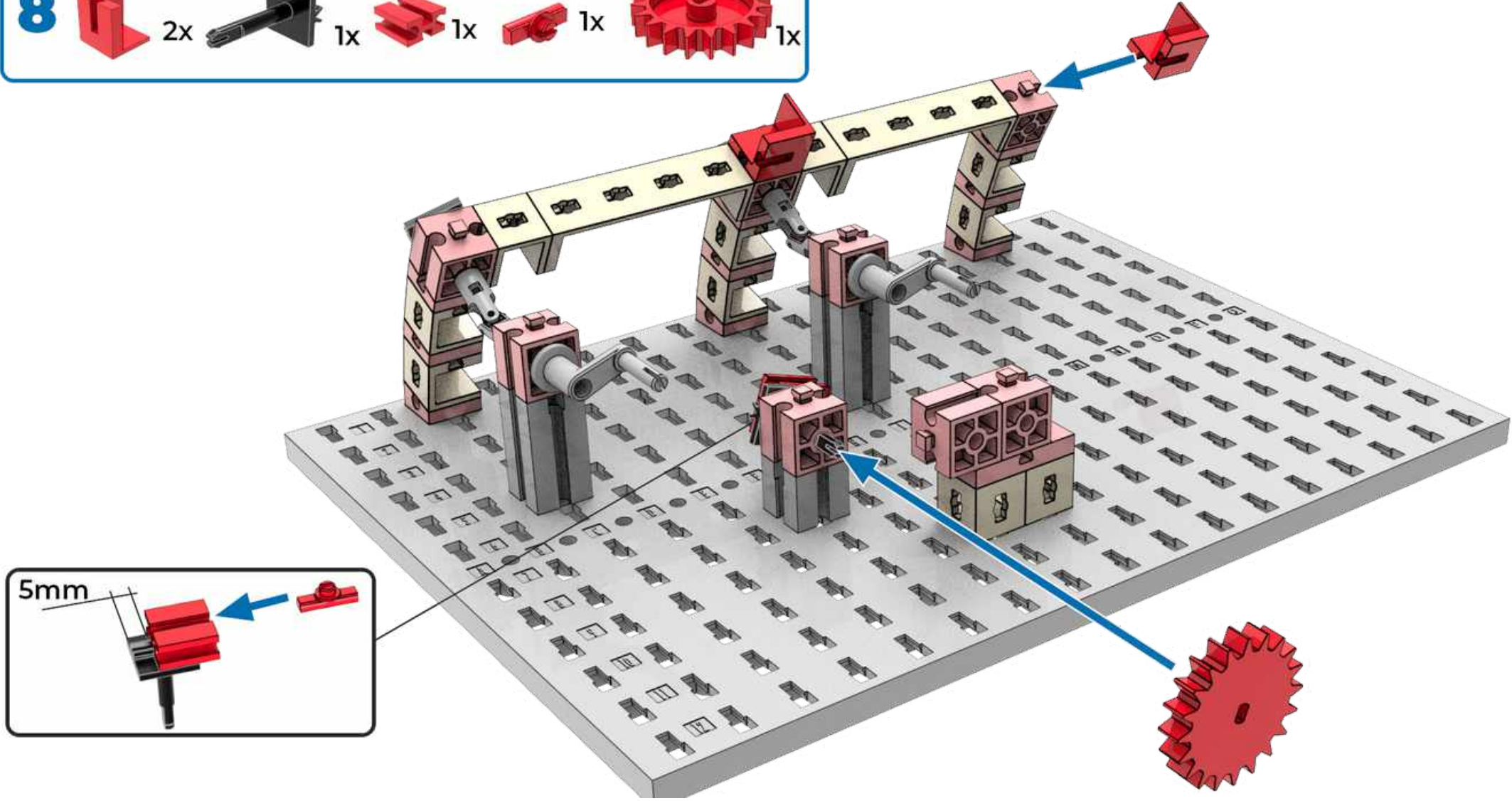

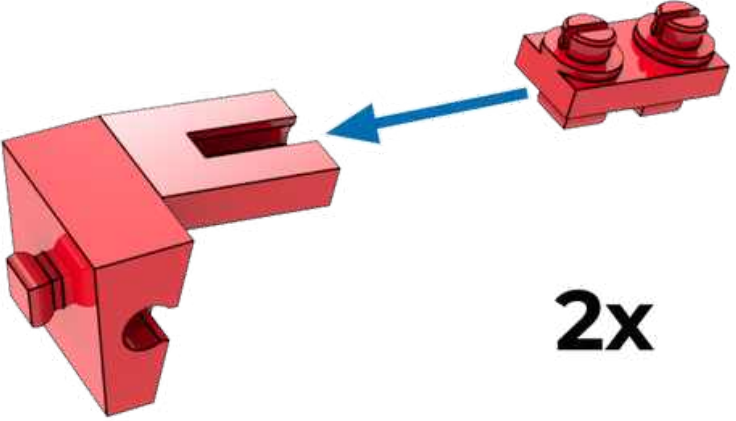

9 ^{15°} 2x 2x 2x

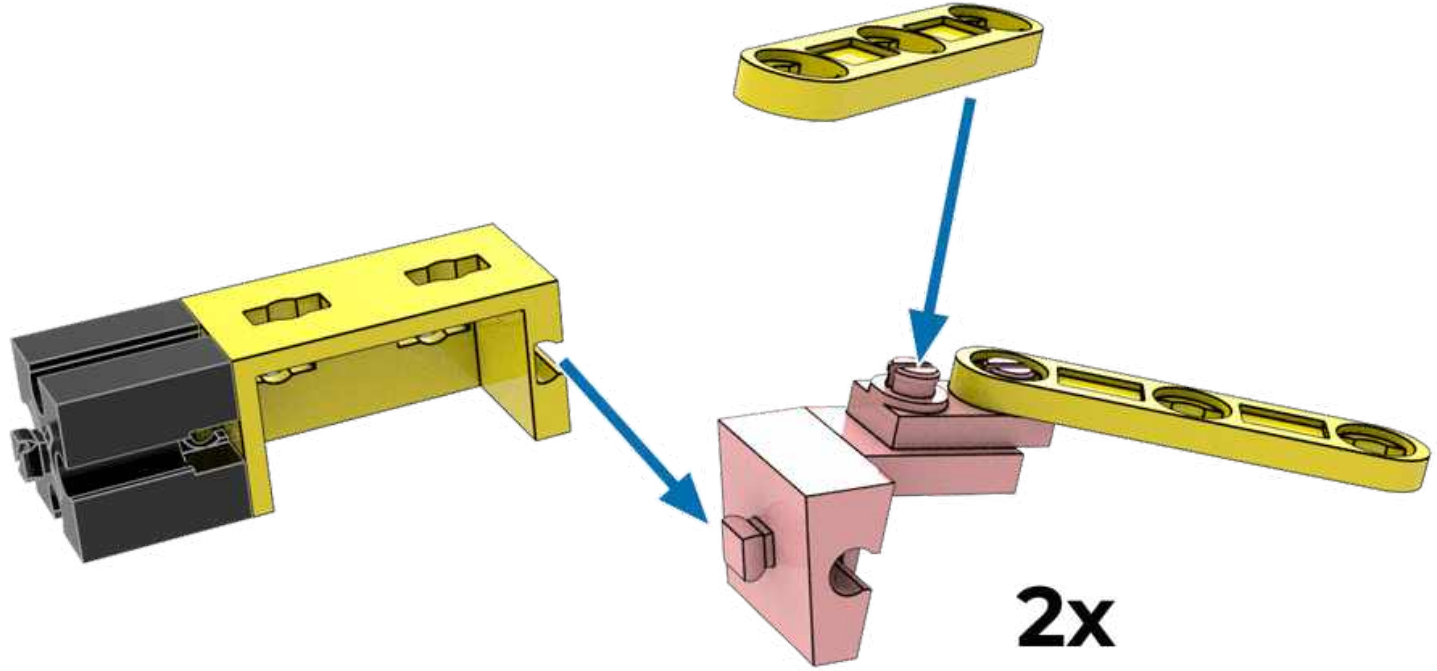

10  2x  2x  4x

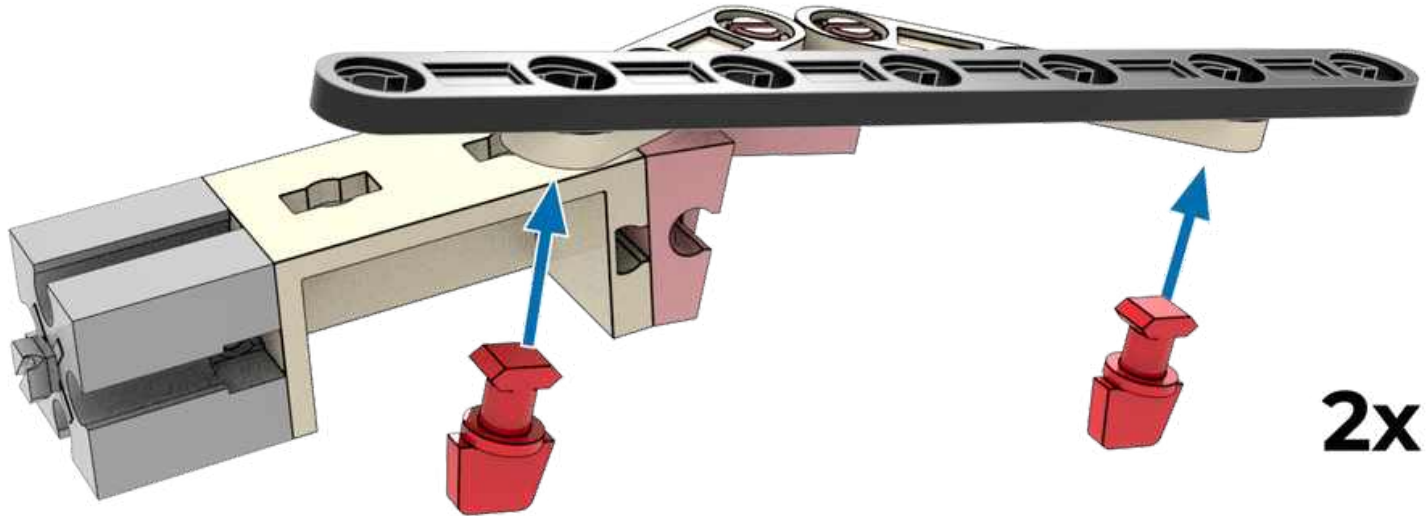

11 90 2x 4 4x



12 90 1x

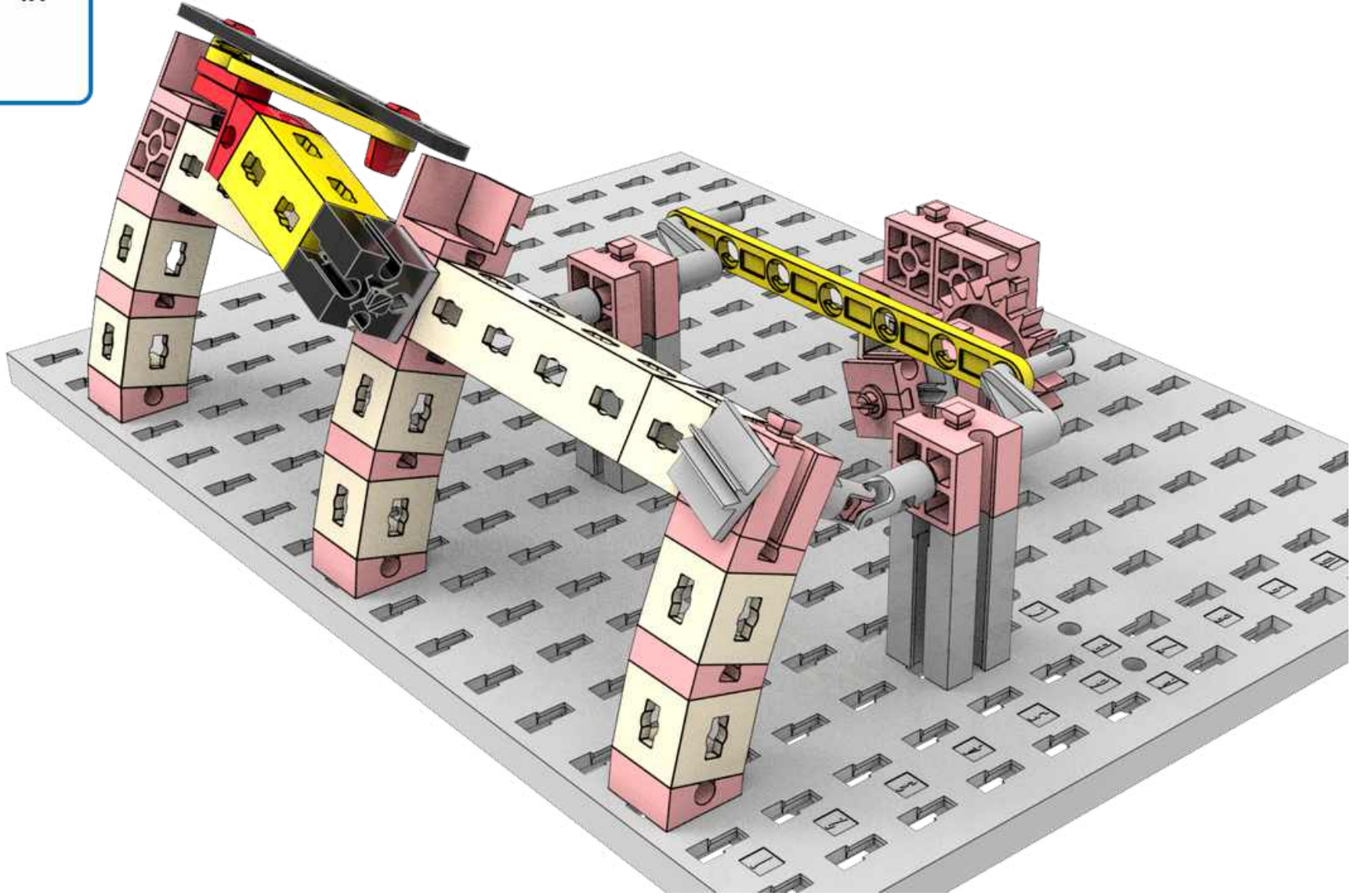

13 45 1x

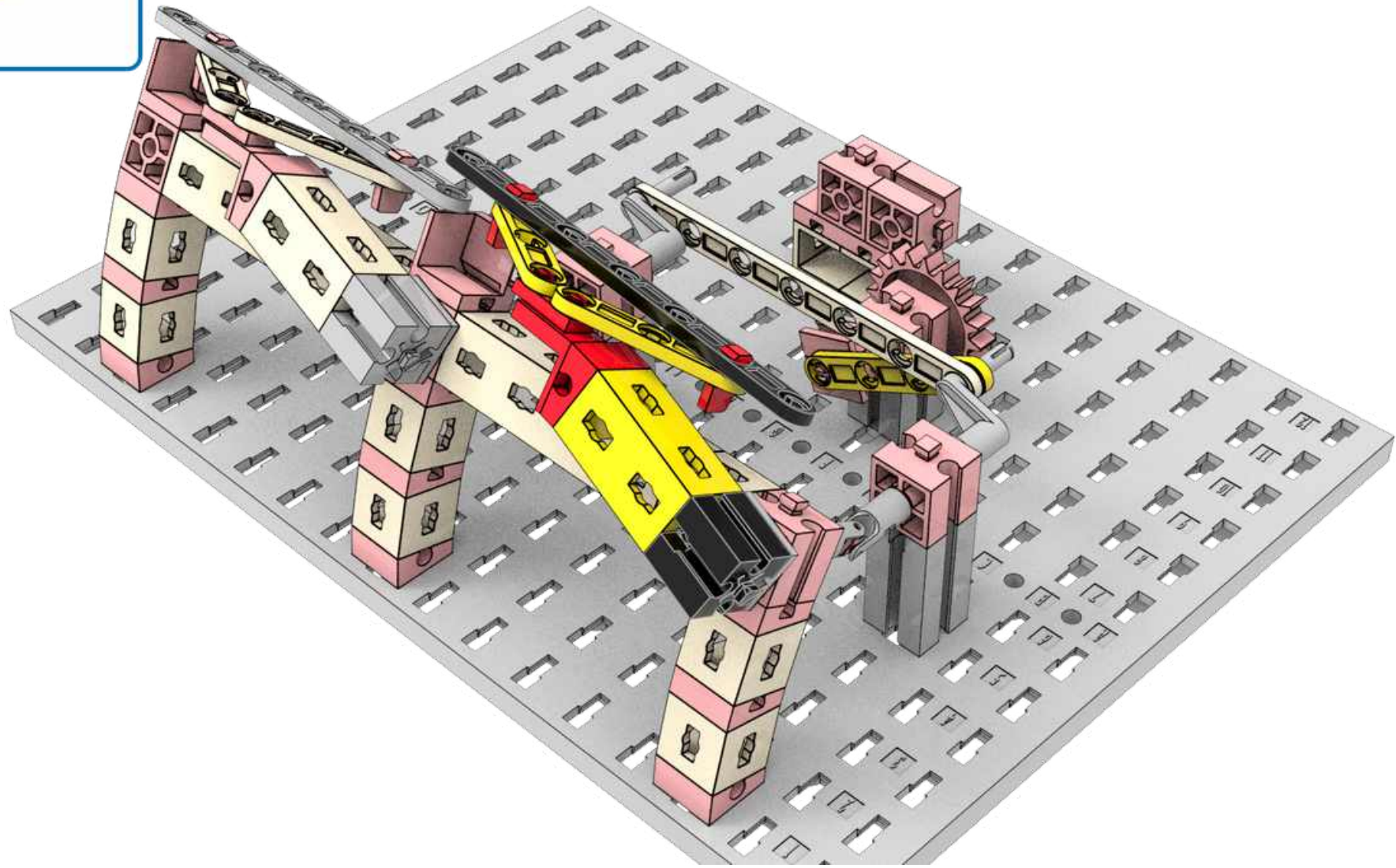

14  1x  1x

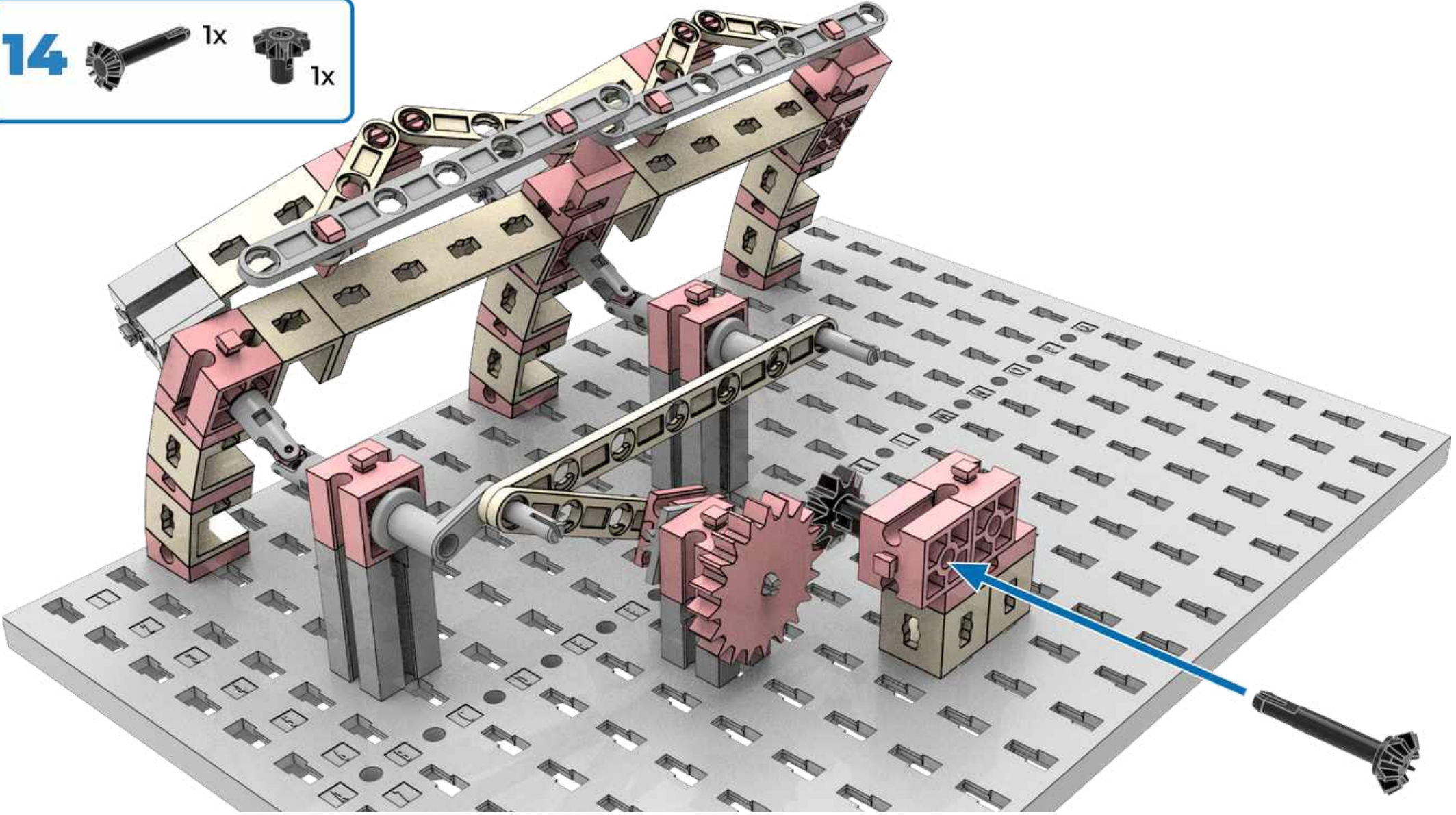



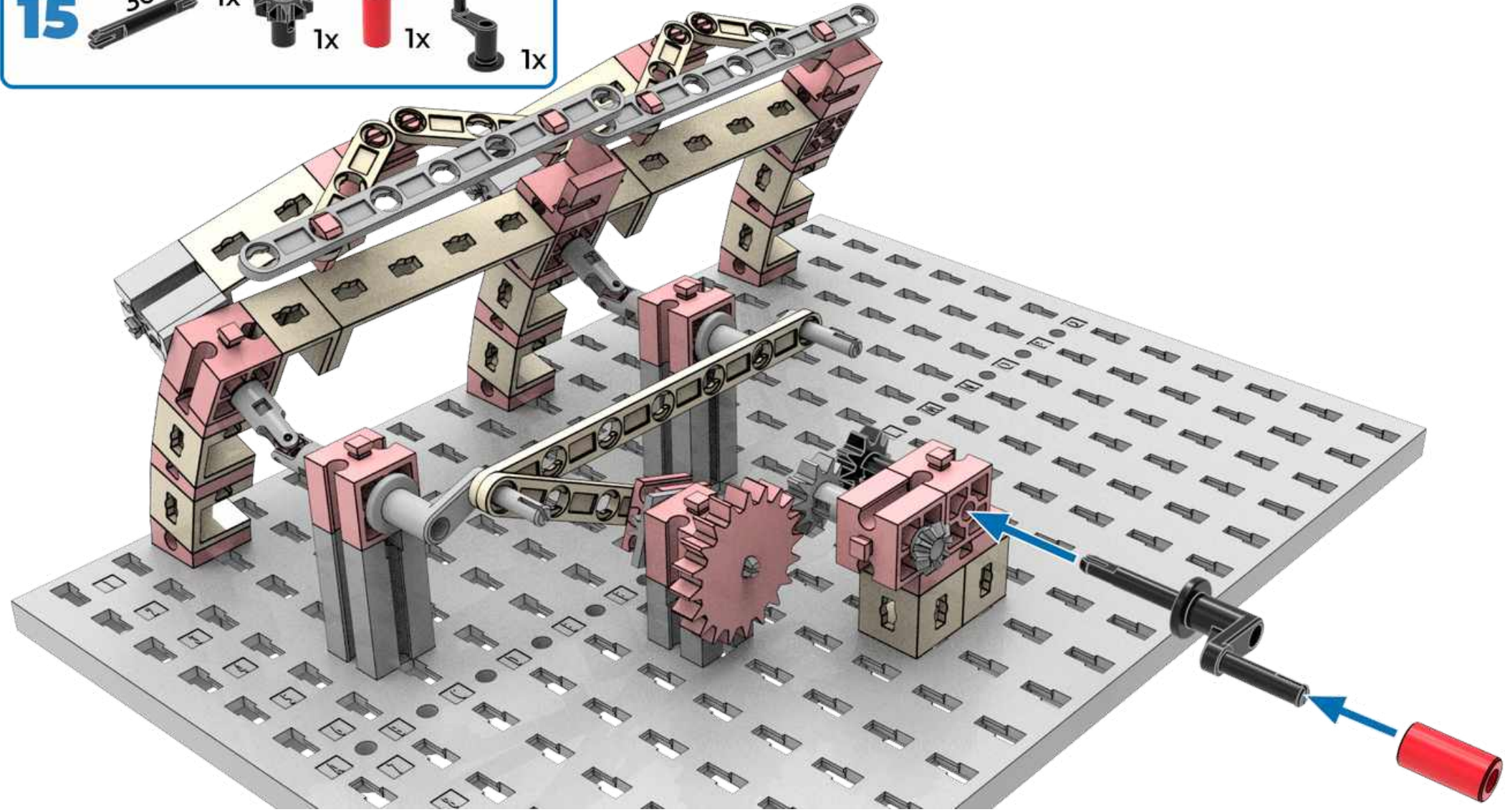
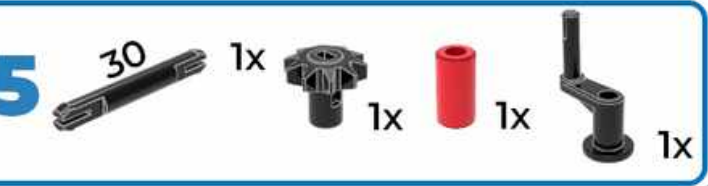

15 30 1x 1x 1x 1x





Federwaage



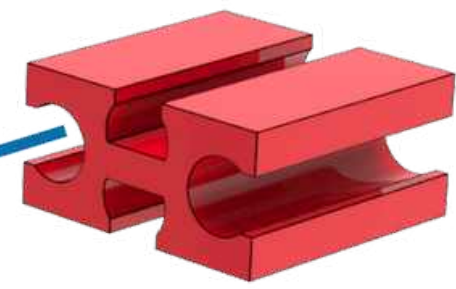
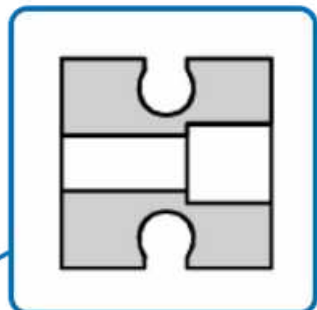
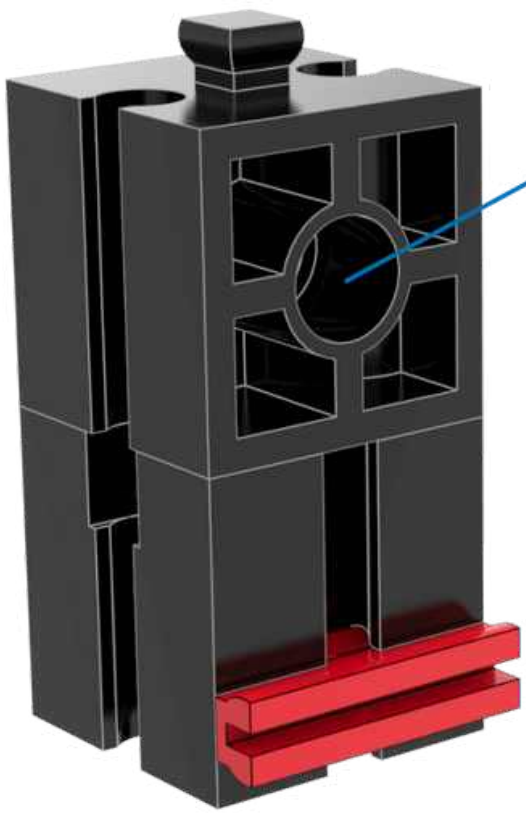

- 1**  1x  1x  1x  1x



2  1x  1x  1x

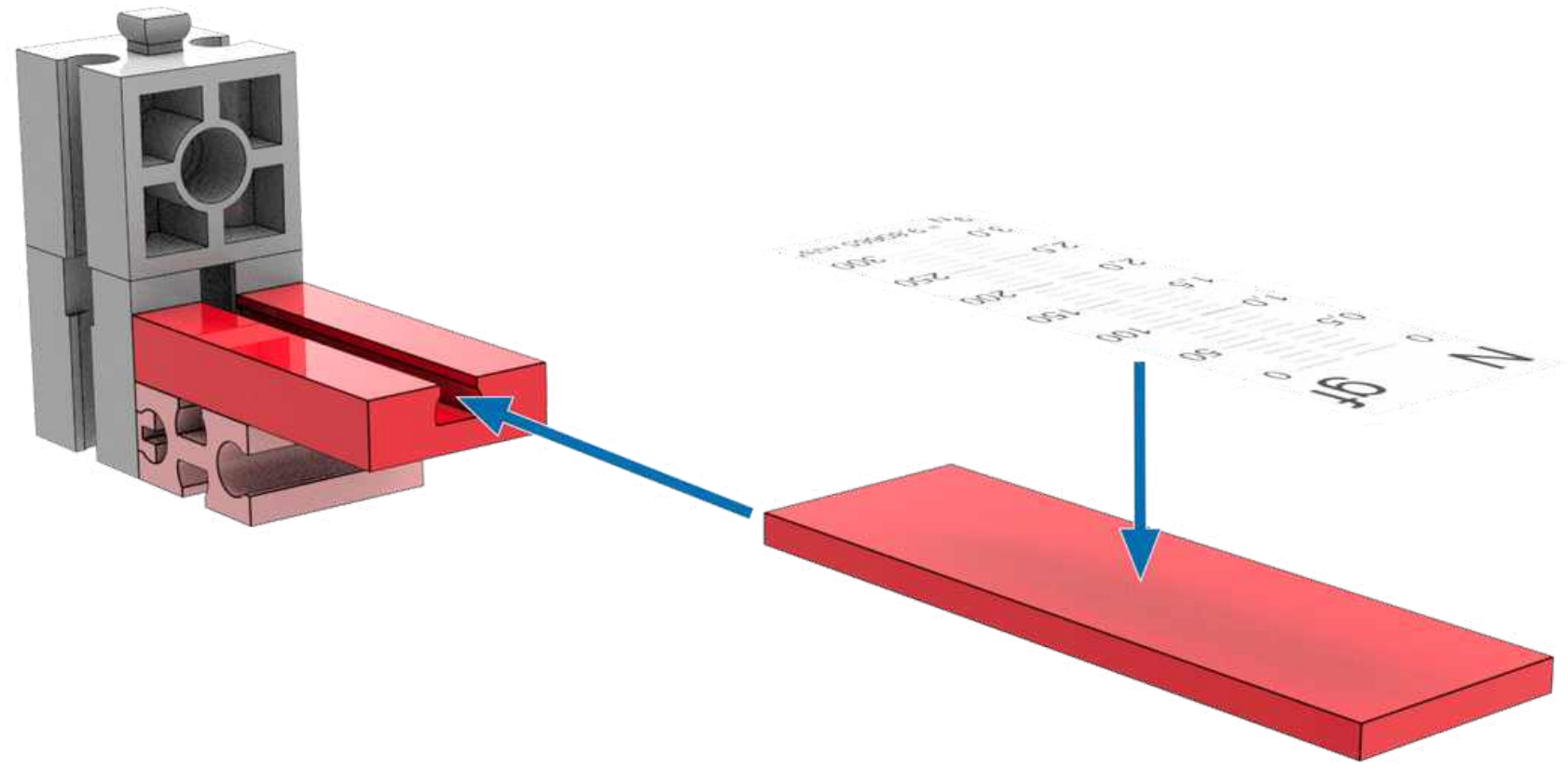

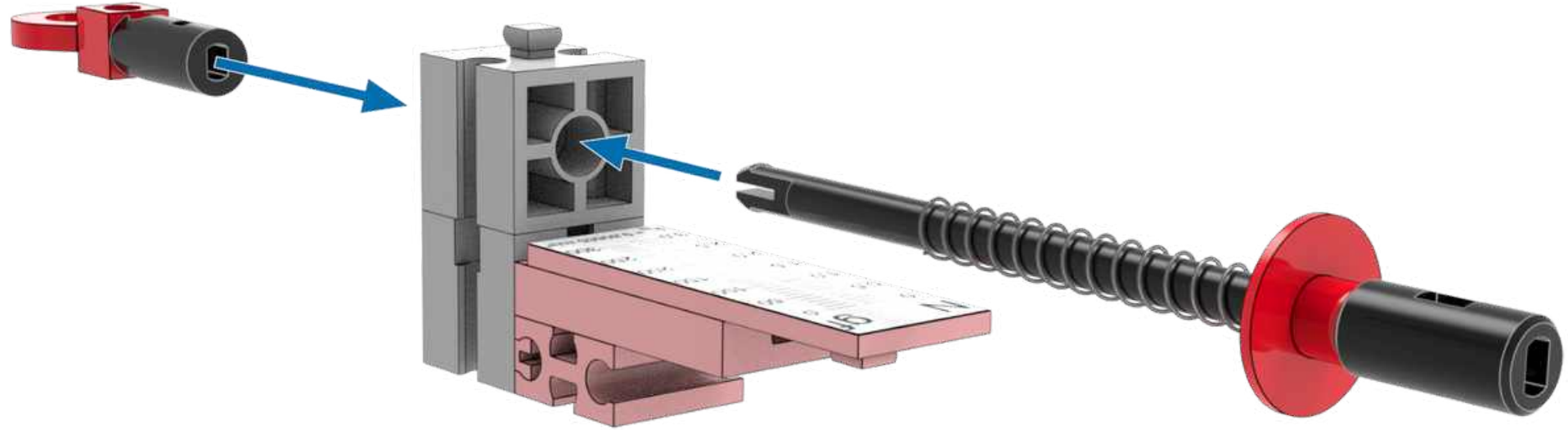
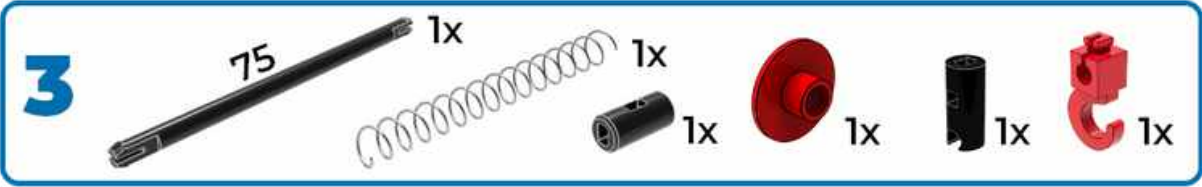

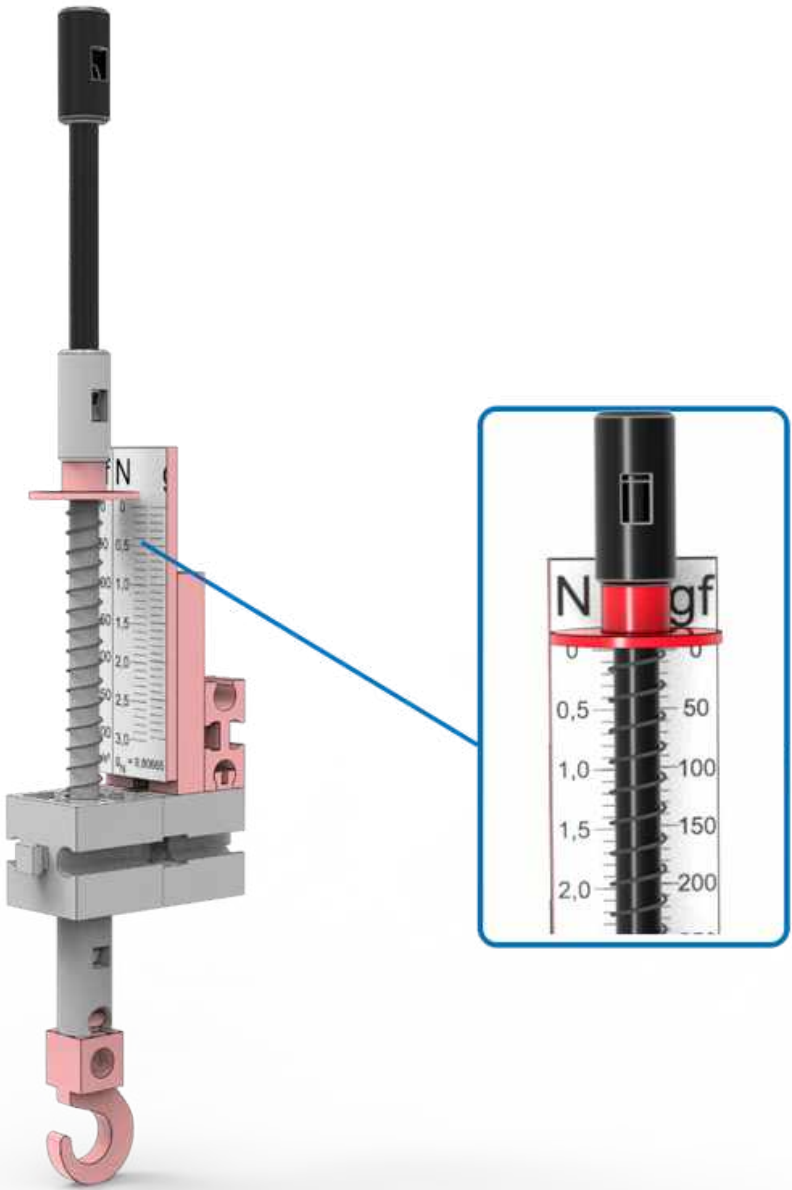

Flaschenzug





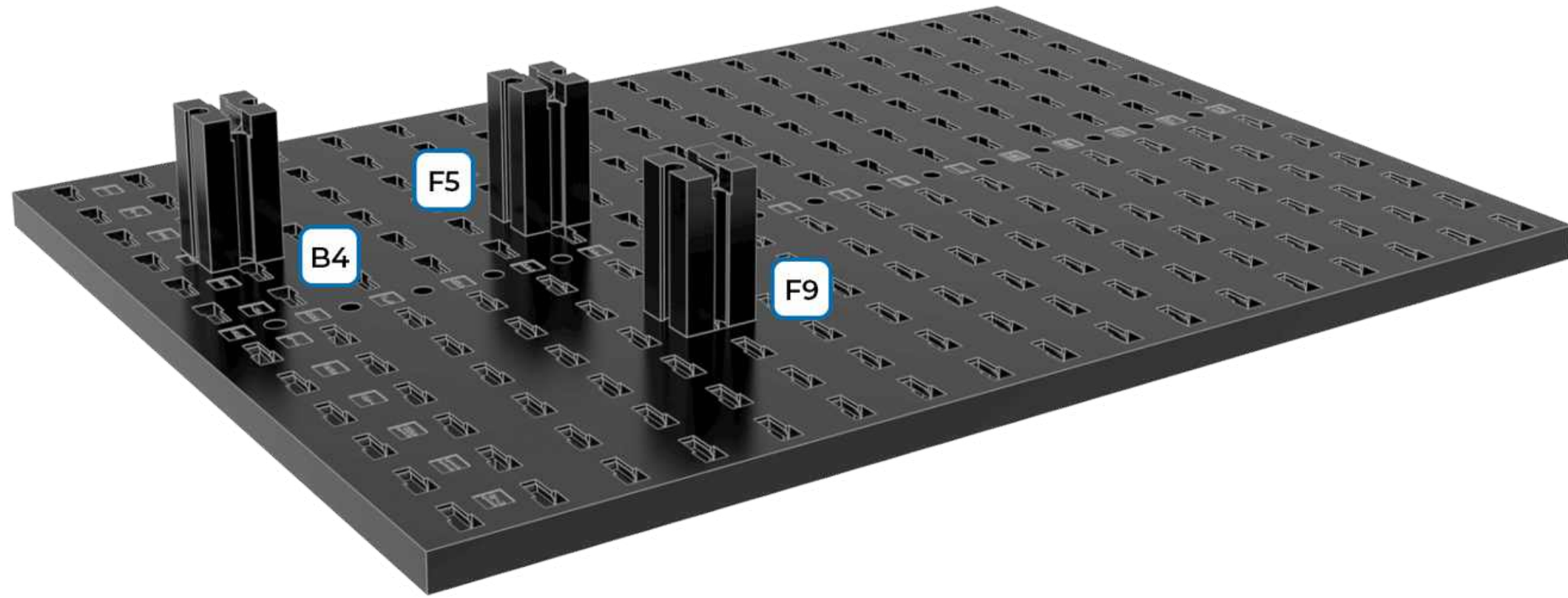
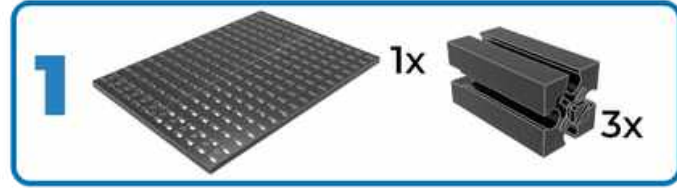

2 ^{30°} 2x 2x 2x 1x

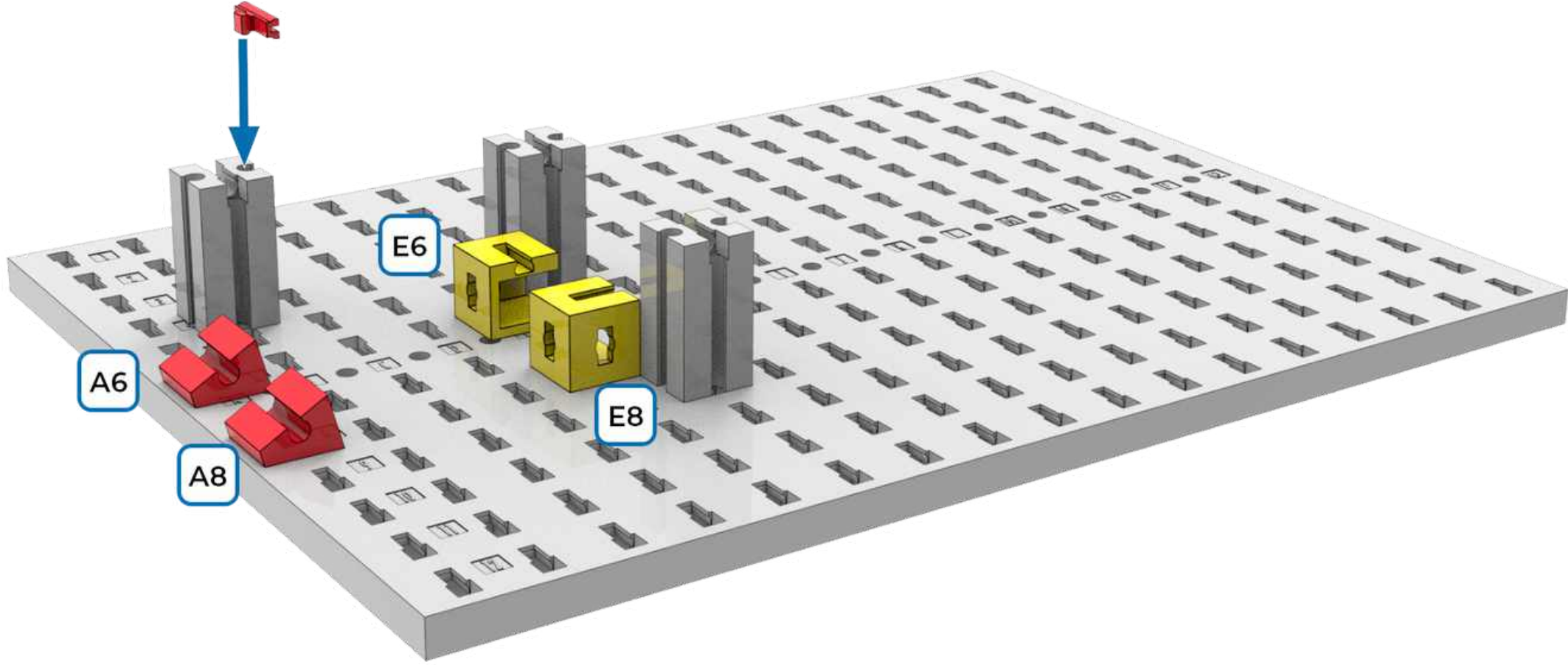

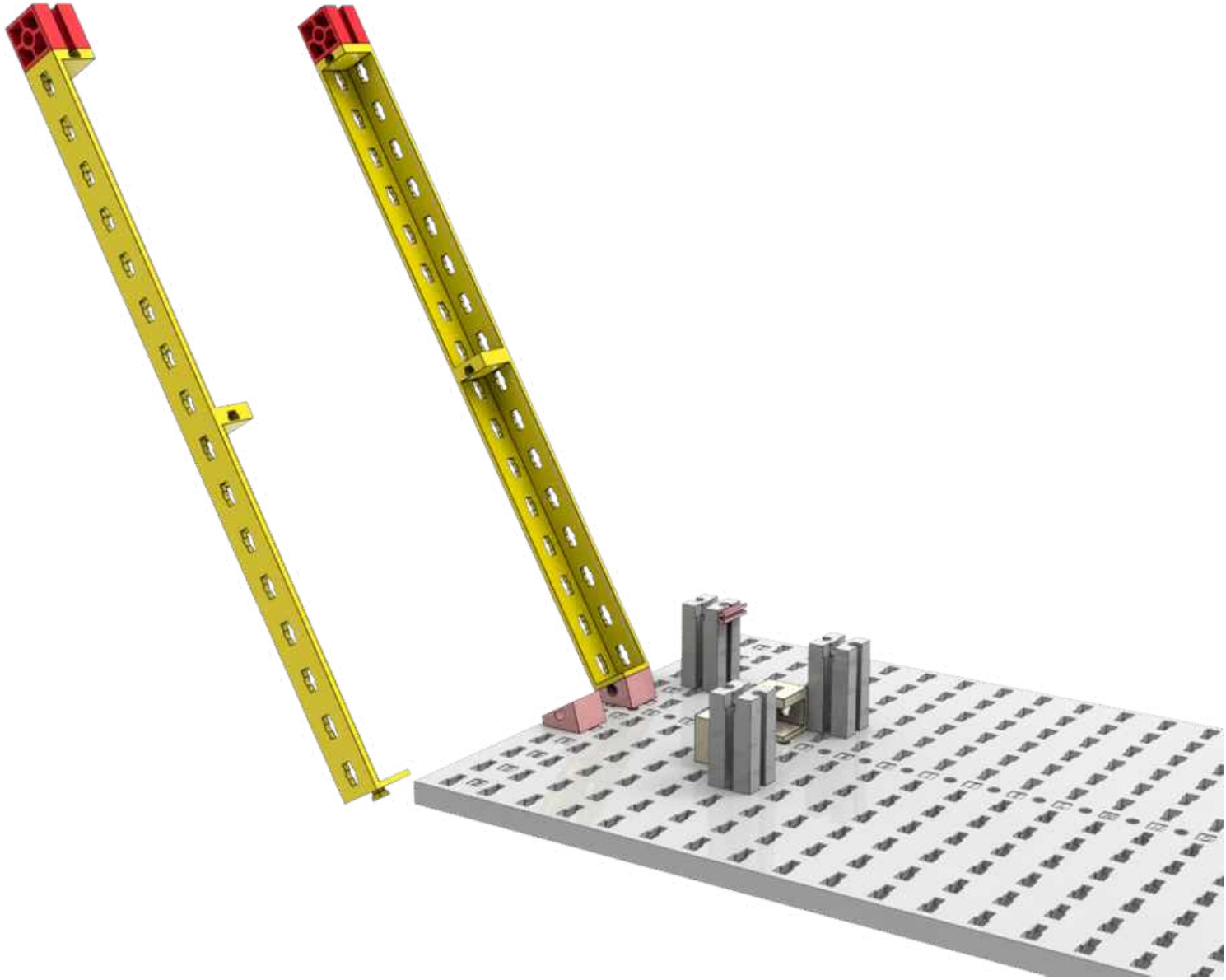

3  4x 2x

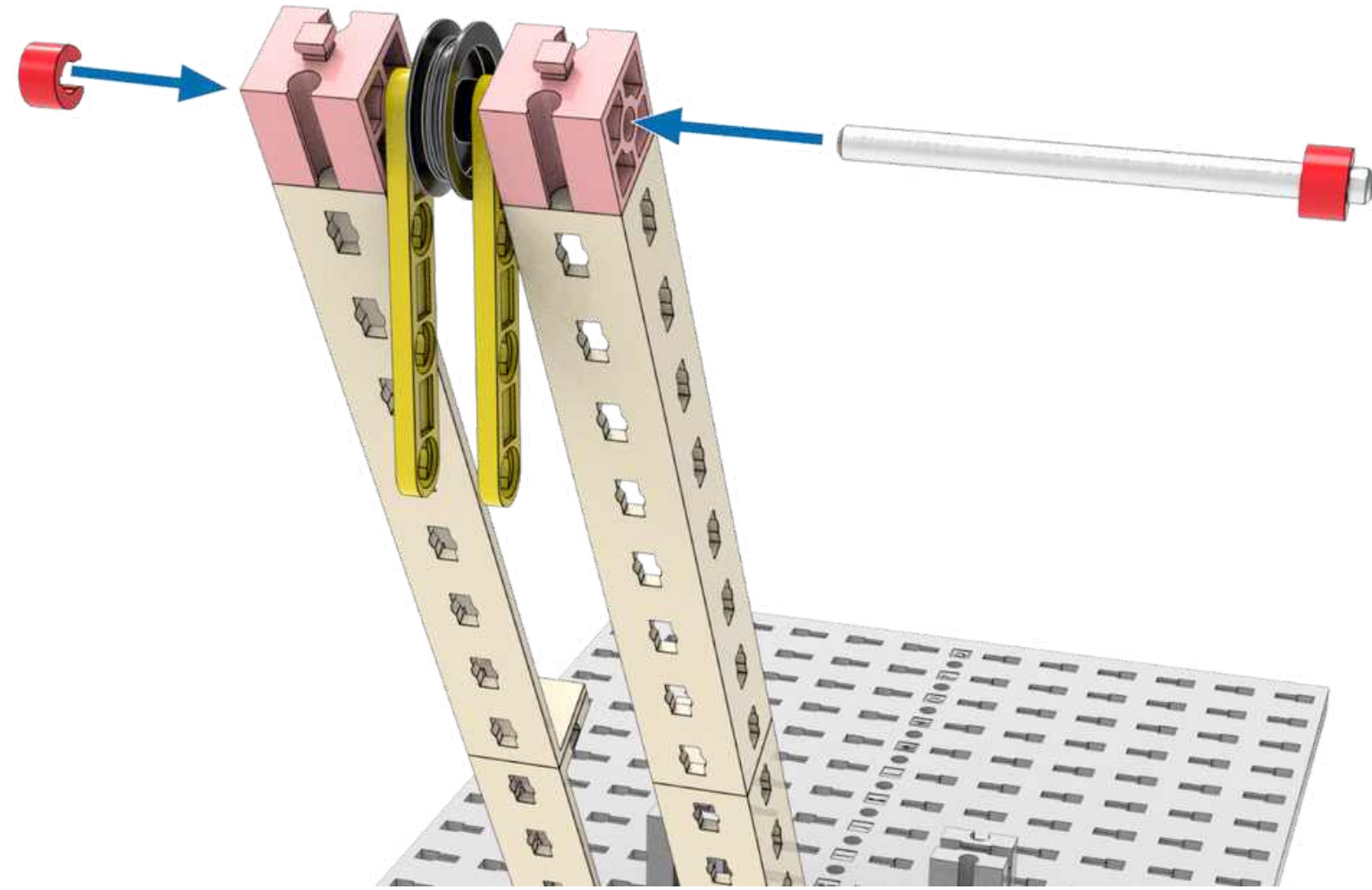
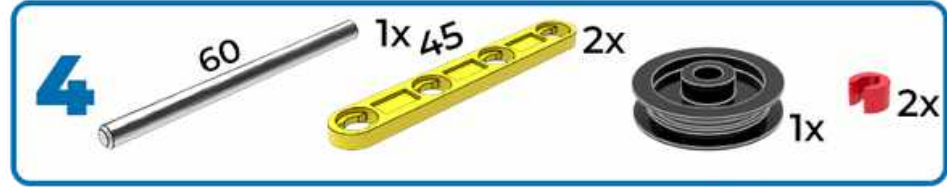

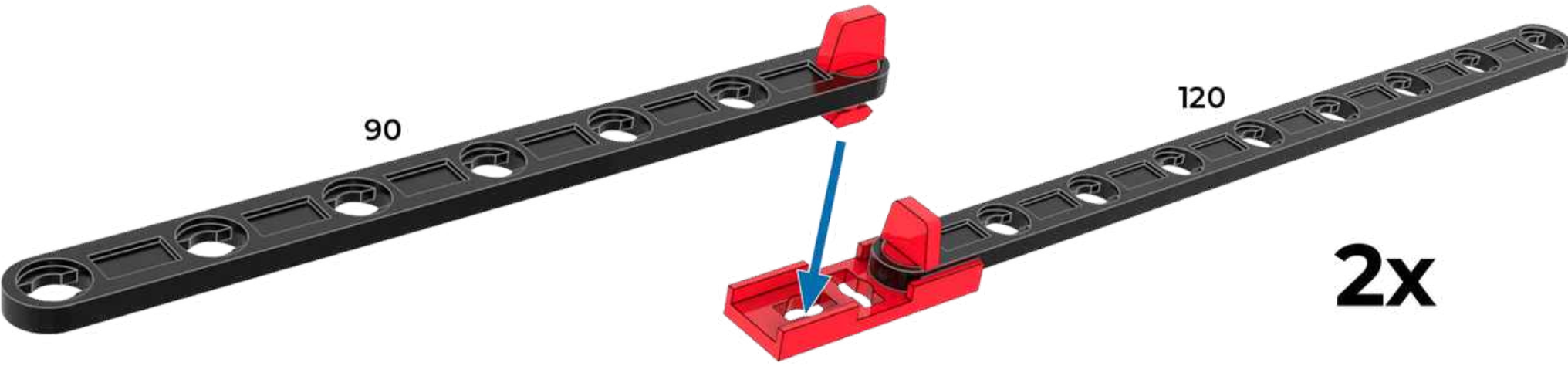

5  2x 90  2x 120  2x  4x





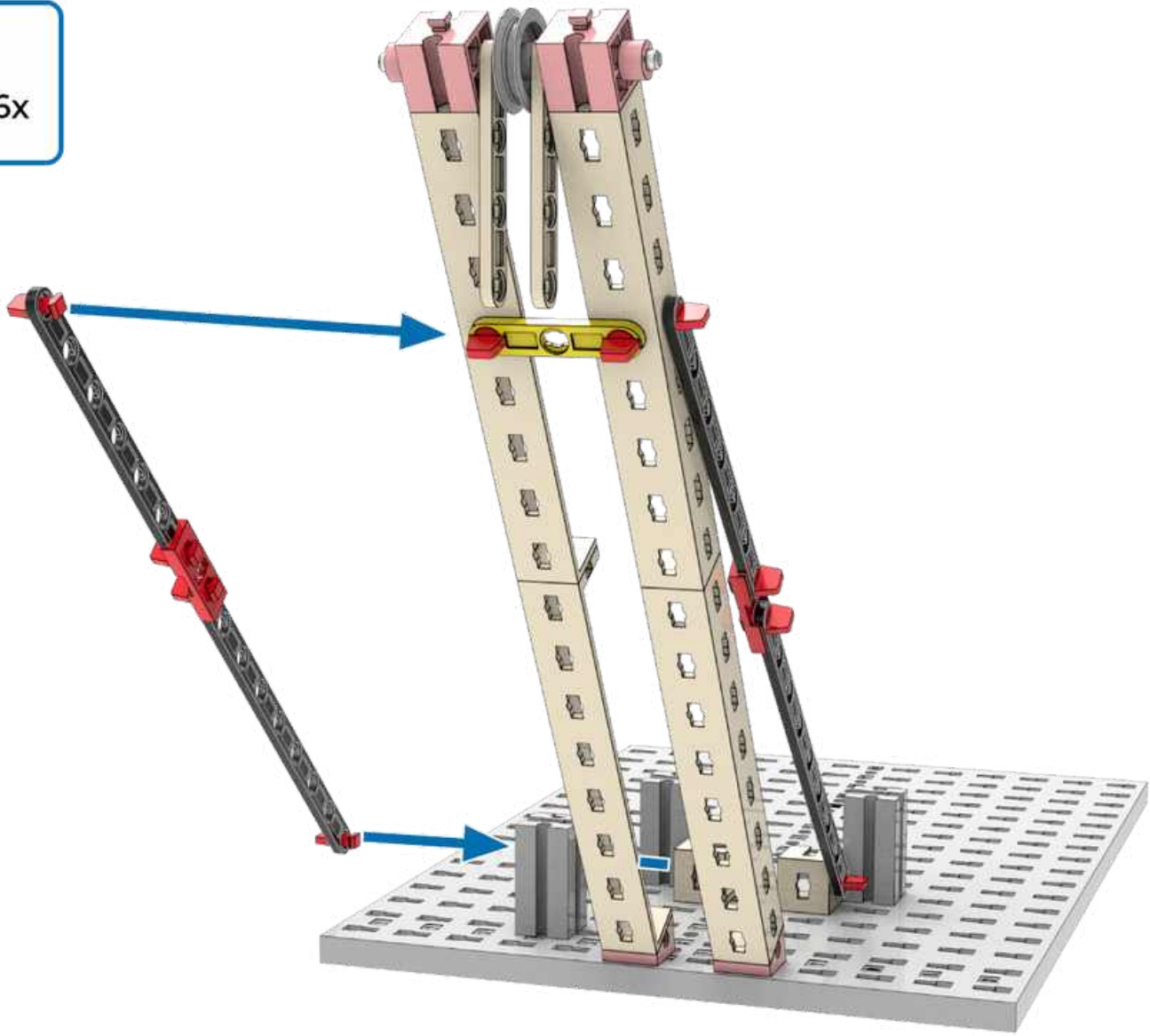

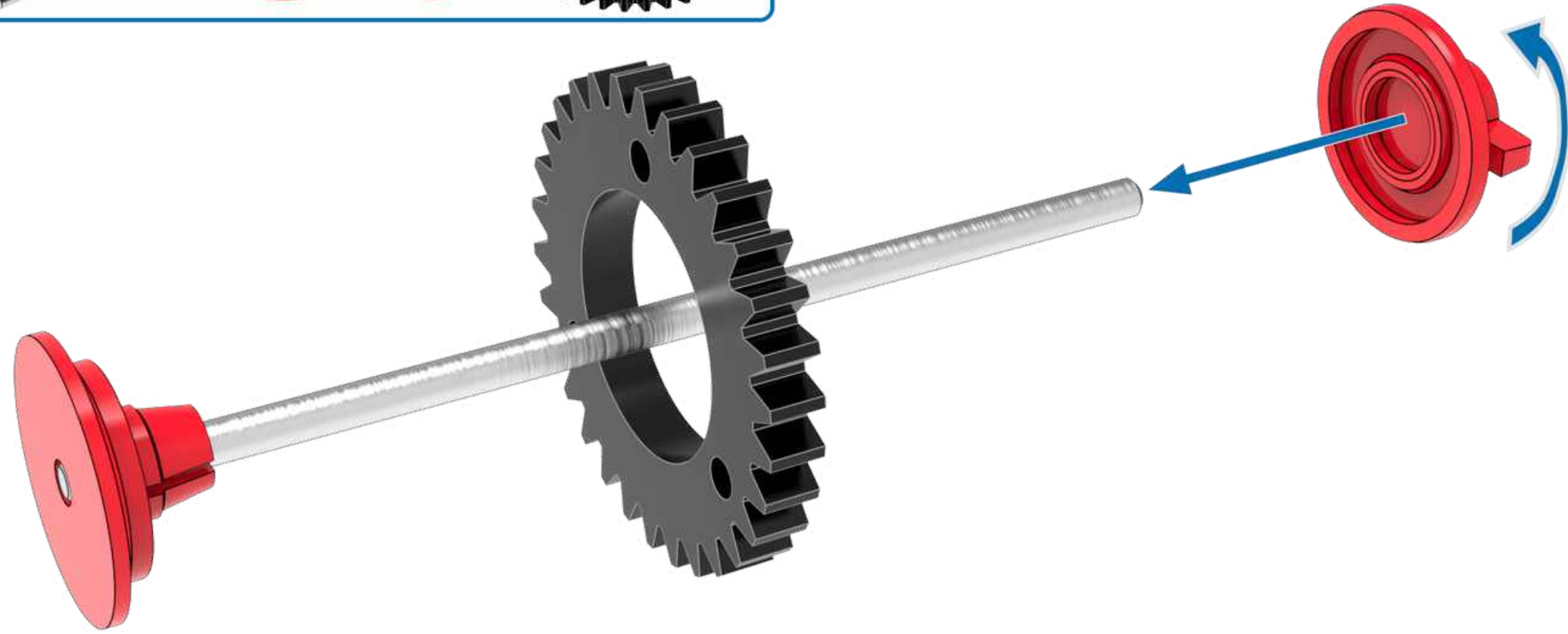
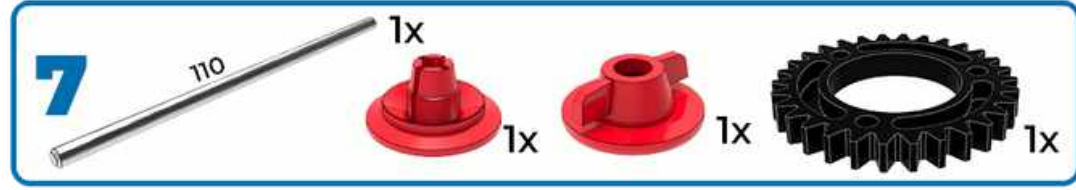
6  1x  6x



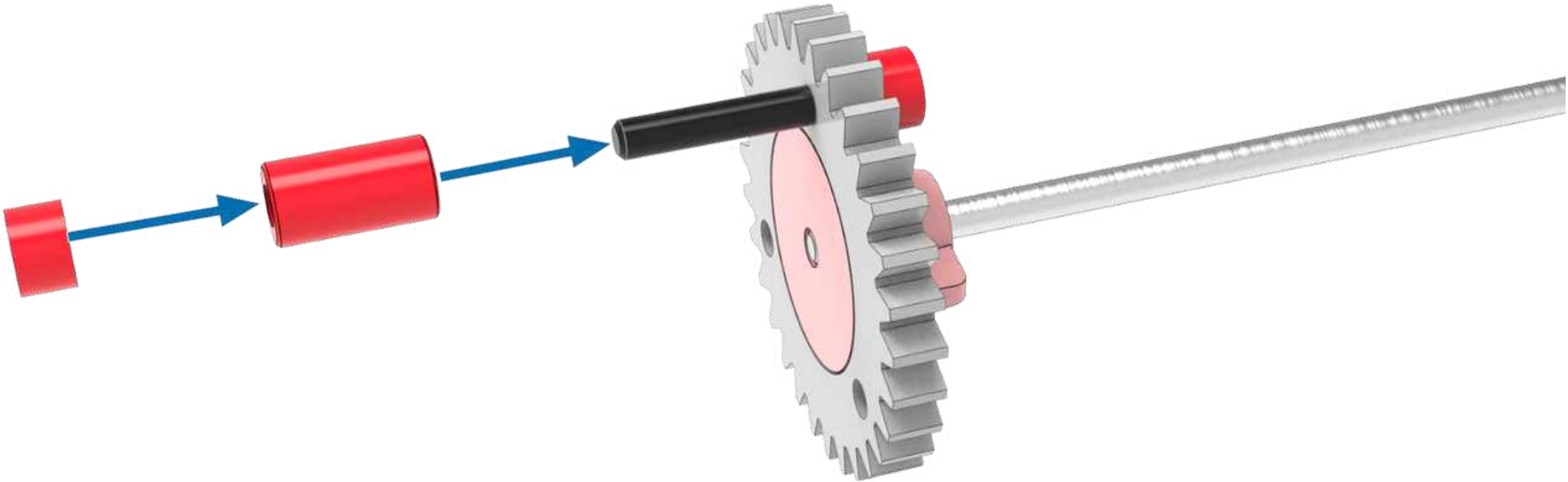





8 30 1x 1x 2x

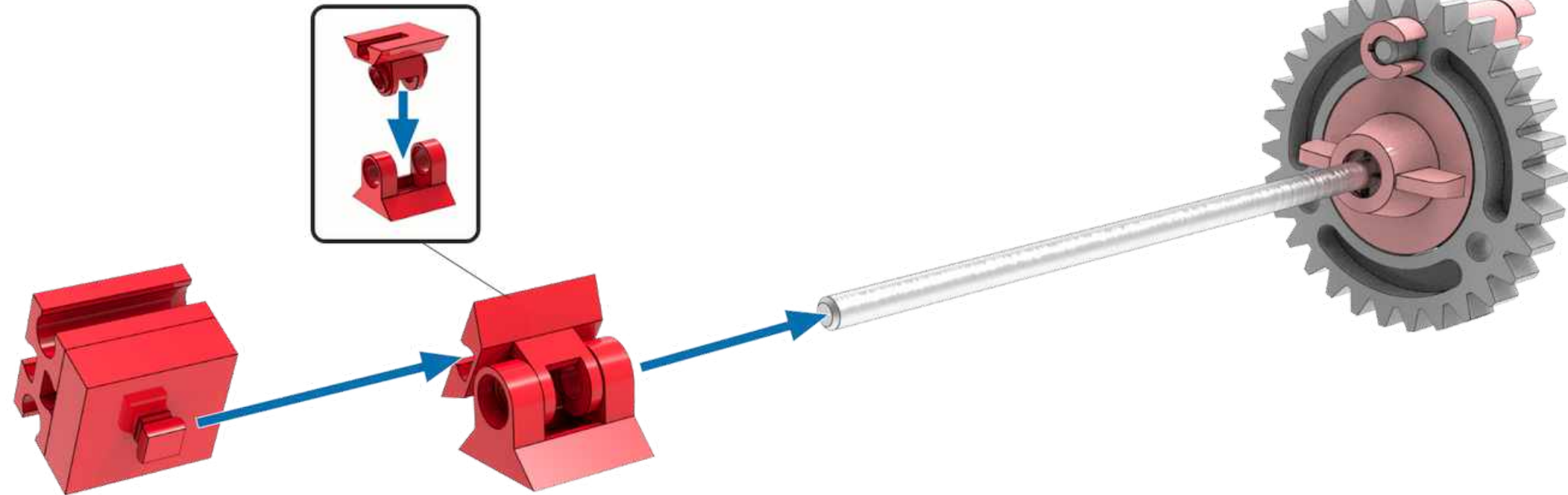

- 9  1x  1x  1x  1x



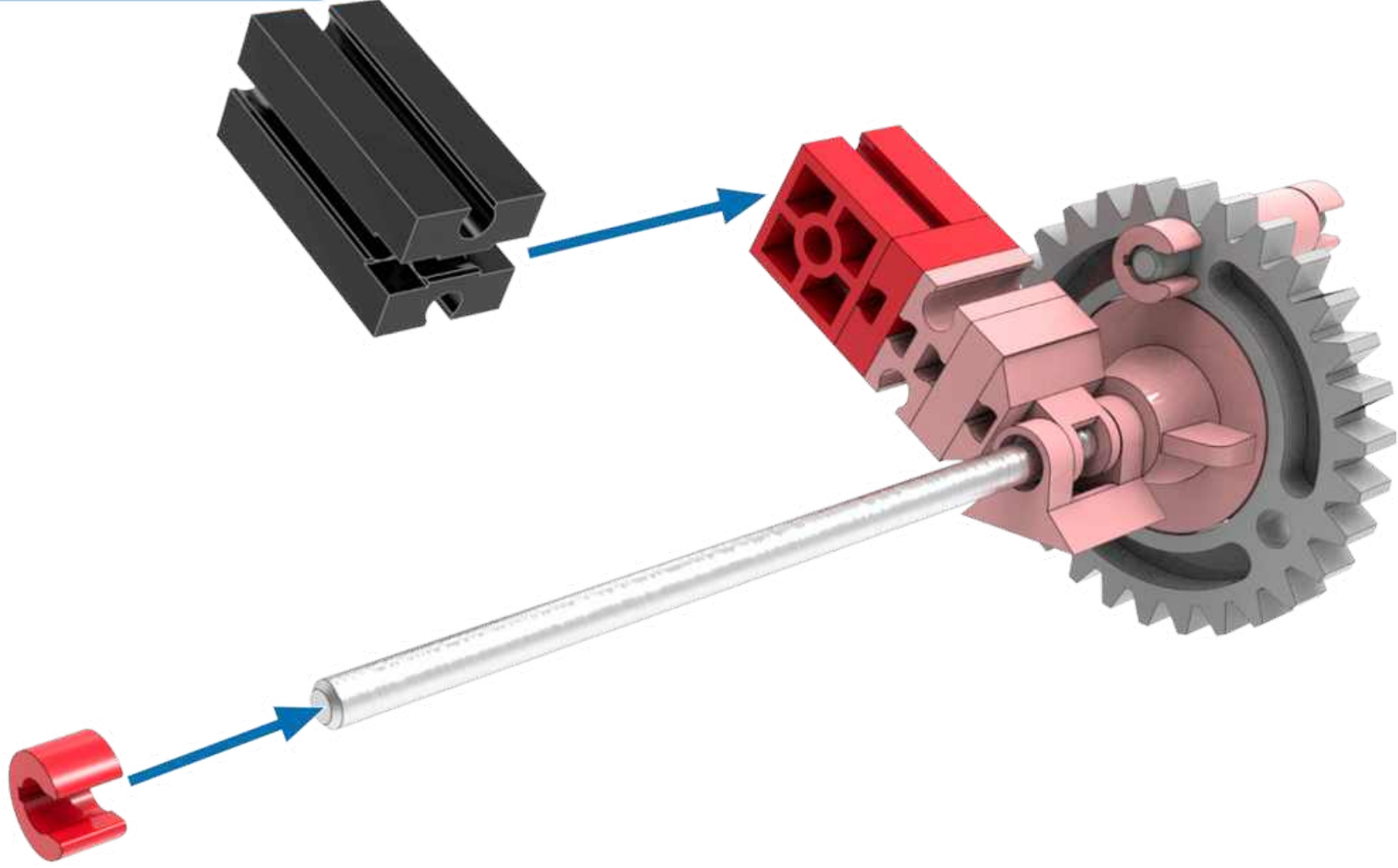

- 10**  1x  1x  1x  1x



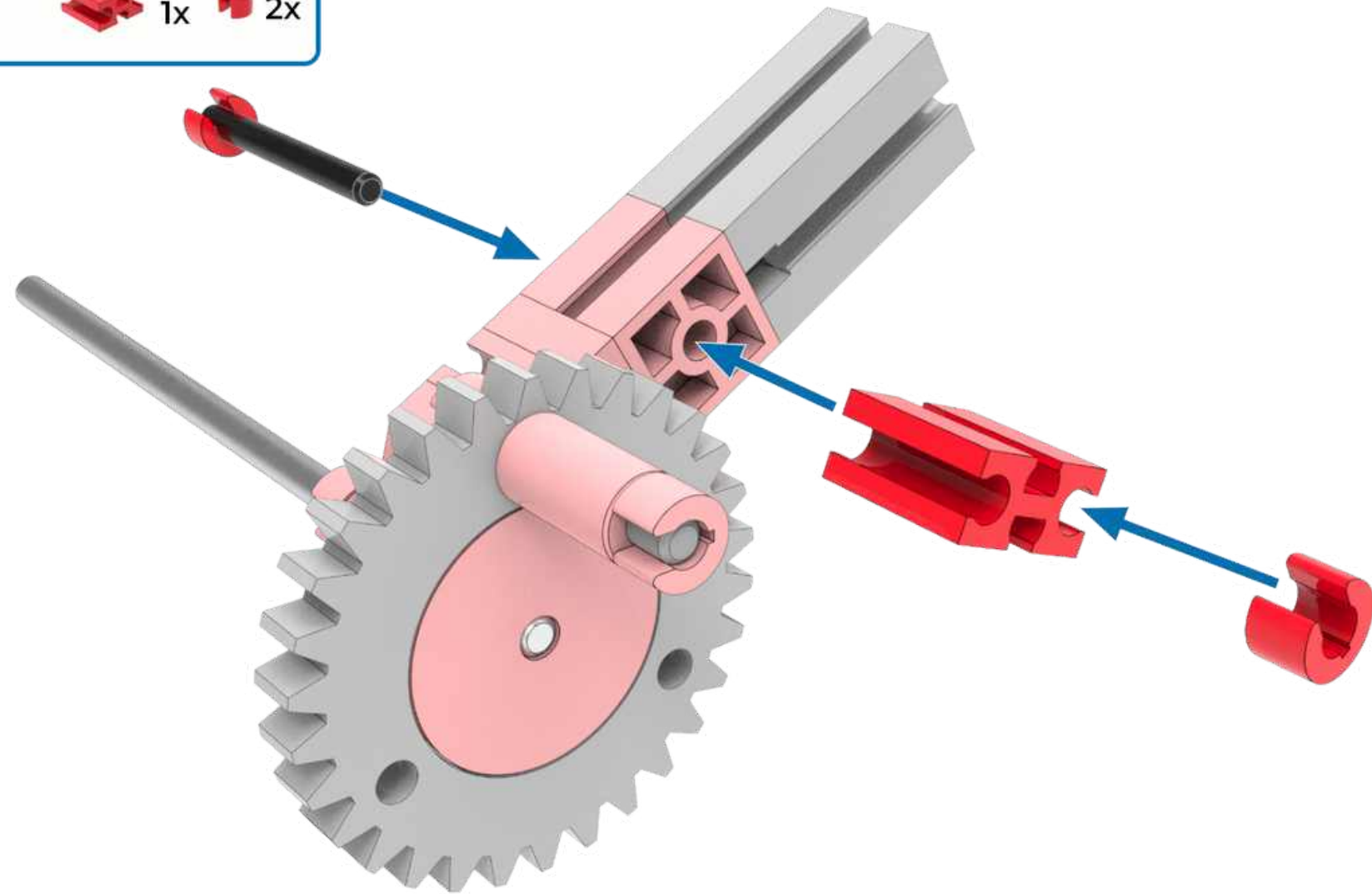



11 30 1x 1x 2x

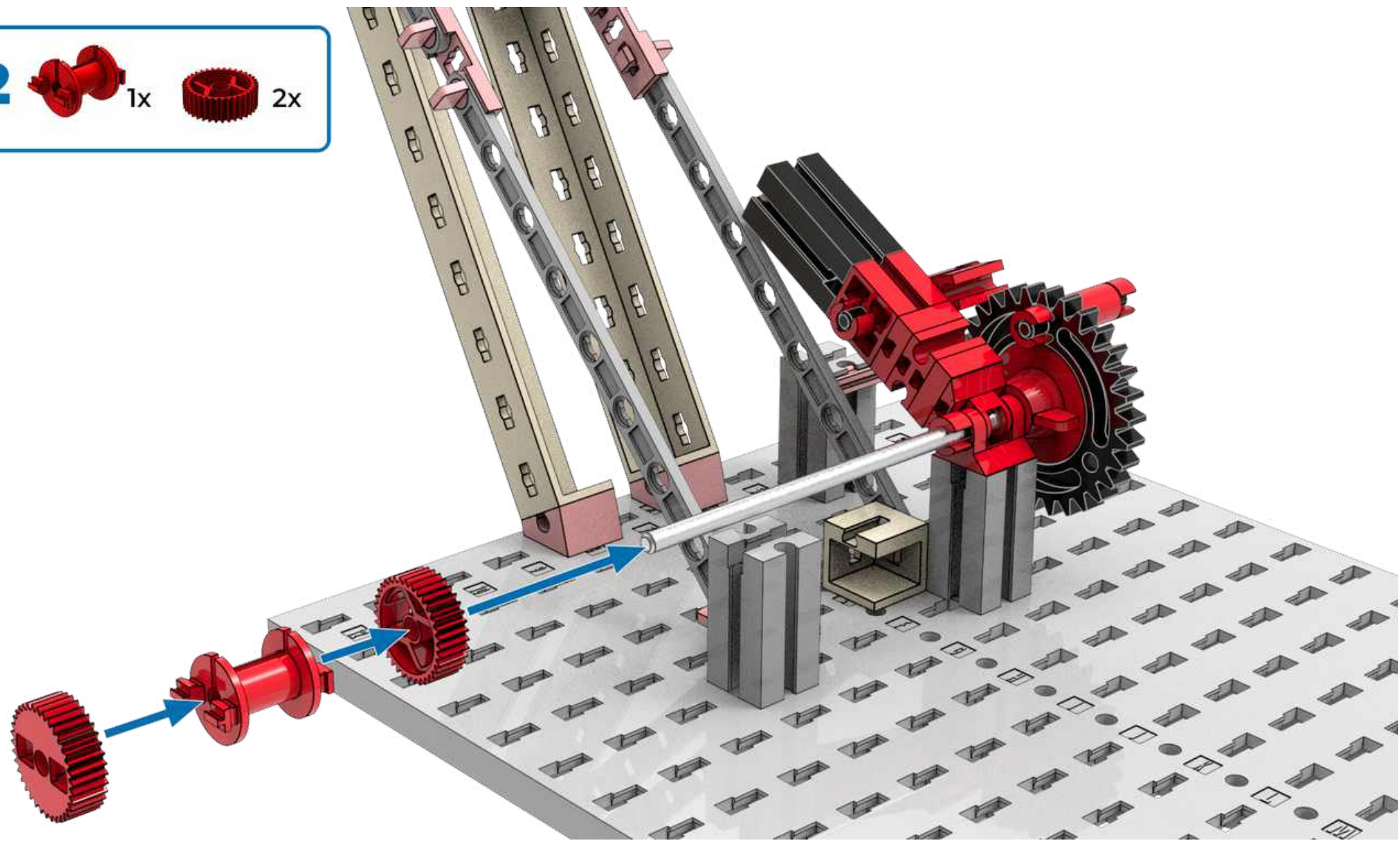

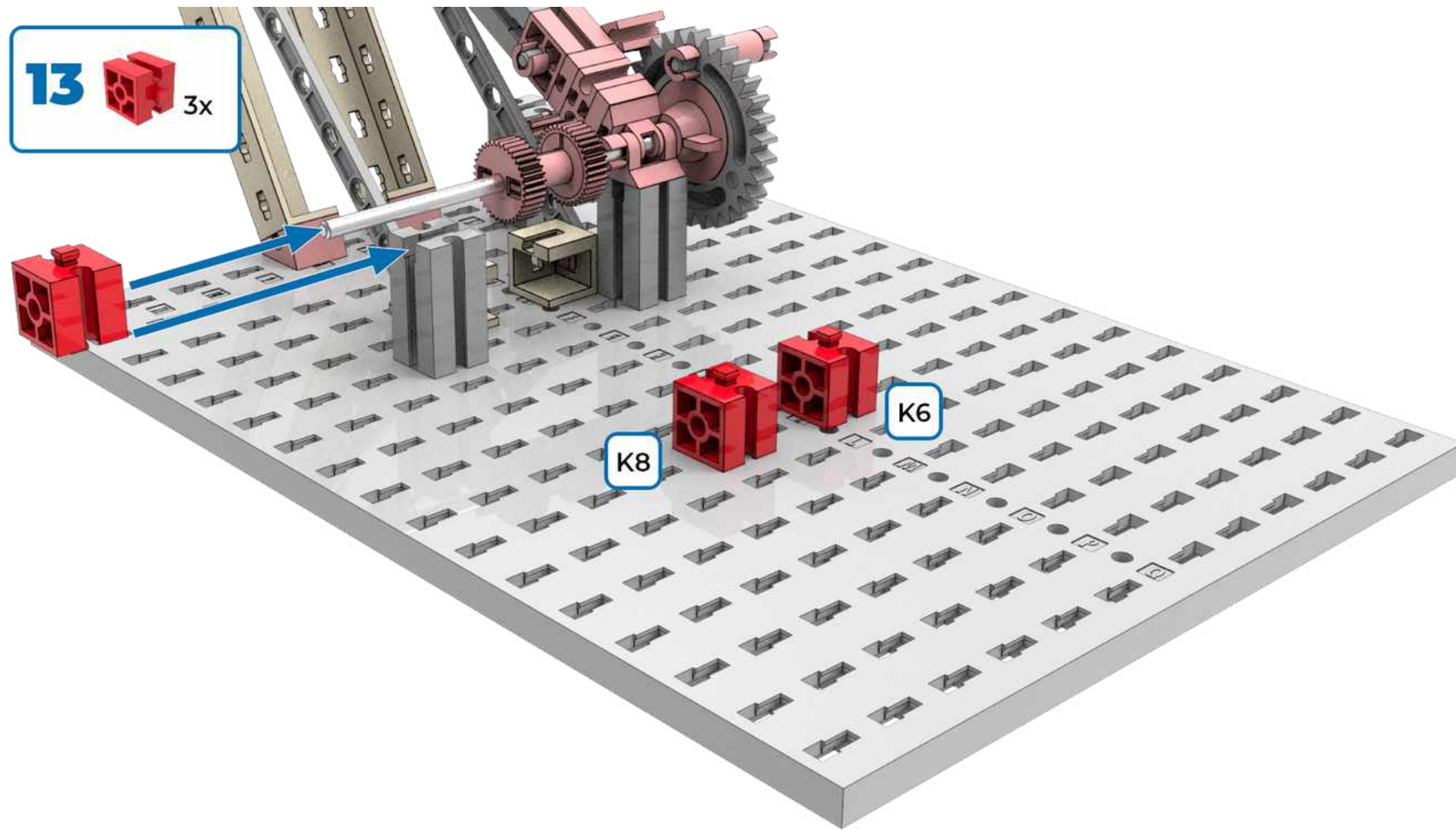



12  1x  2x



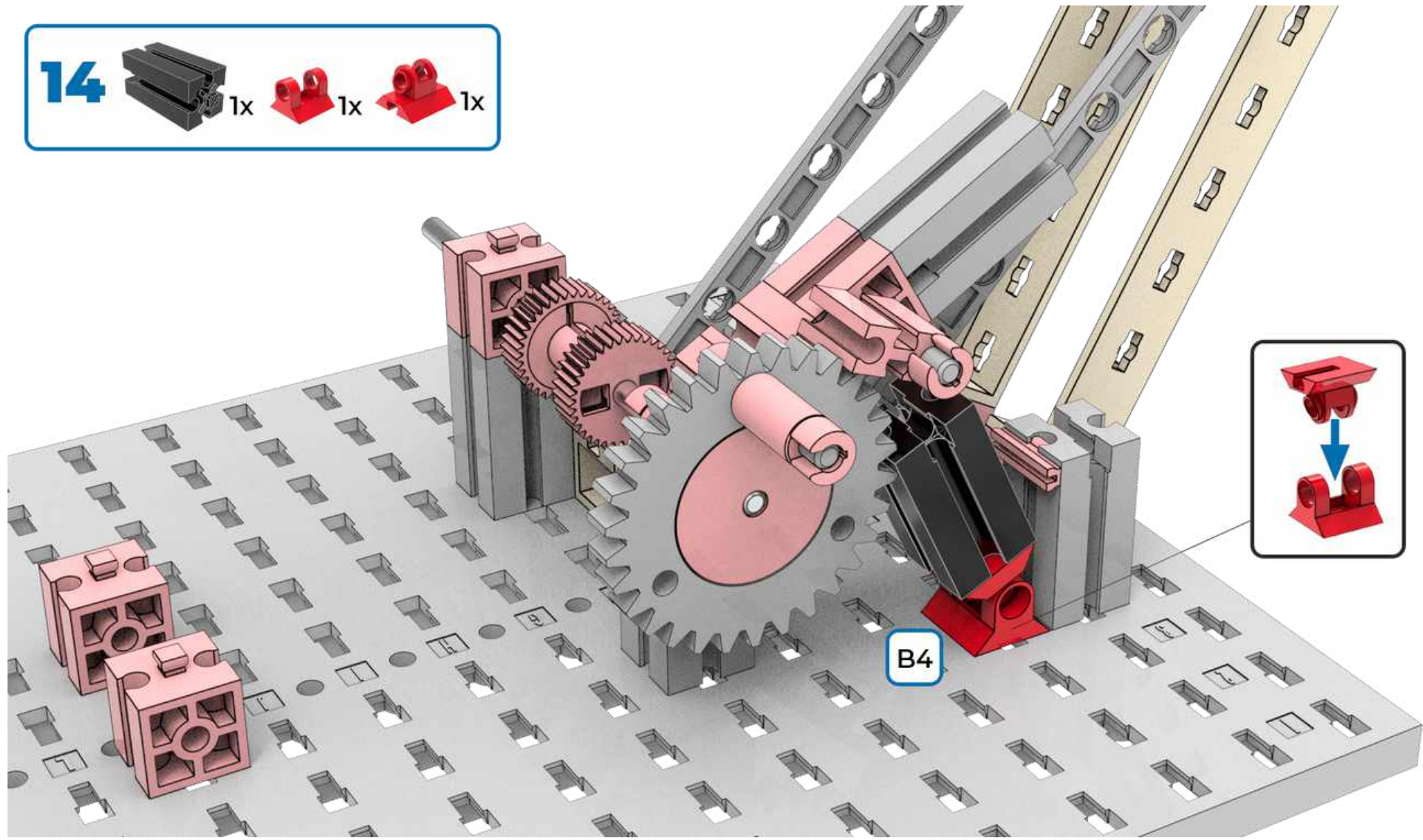

- 14**  1x  1x  1x



- 15**  1x  1x  1x  1x

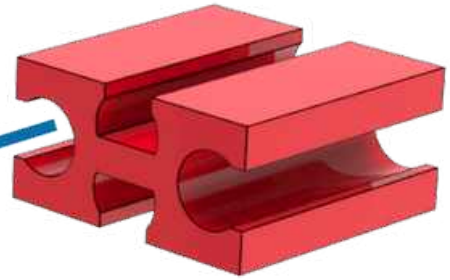
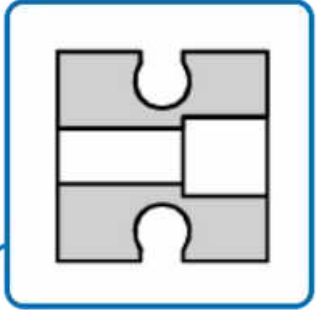
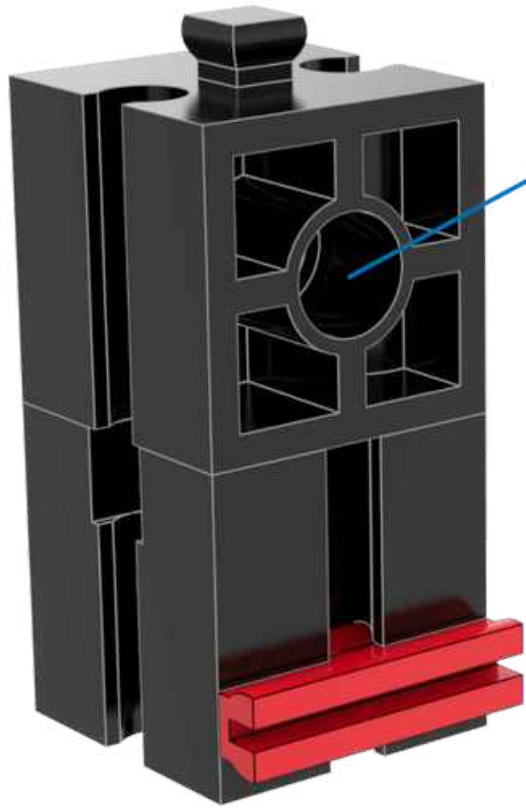

16  1x  1x  1x

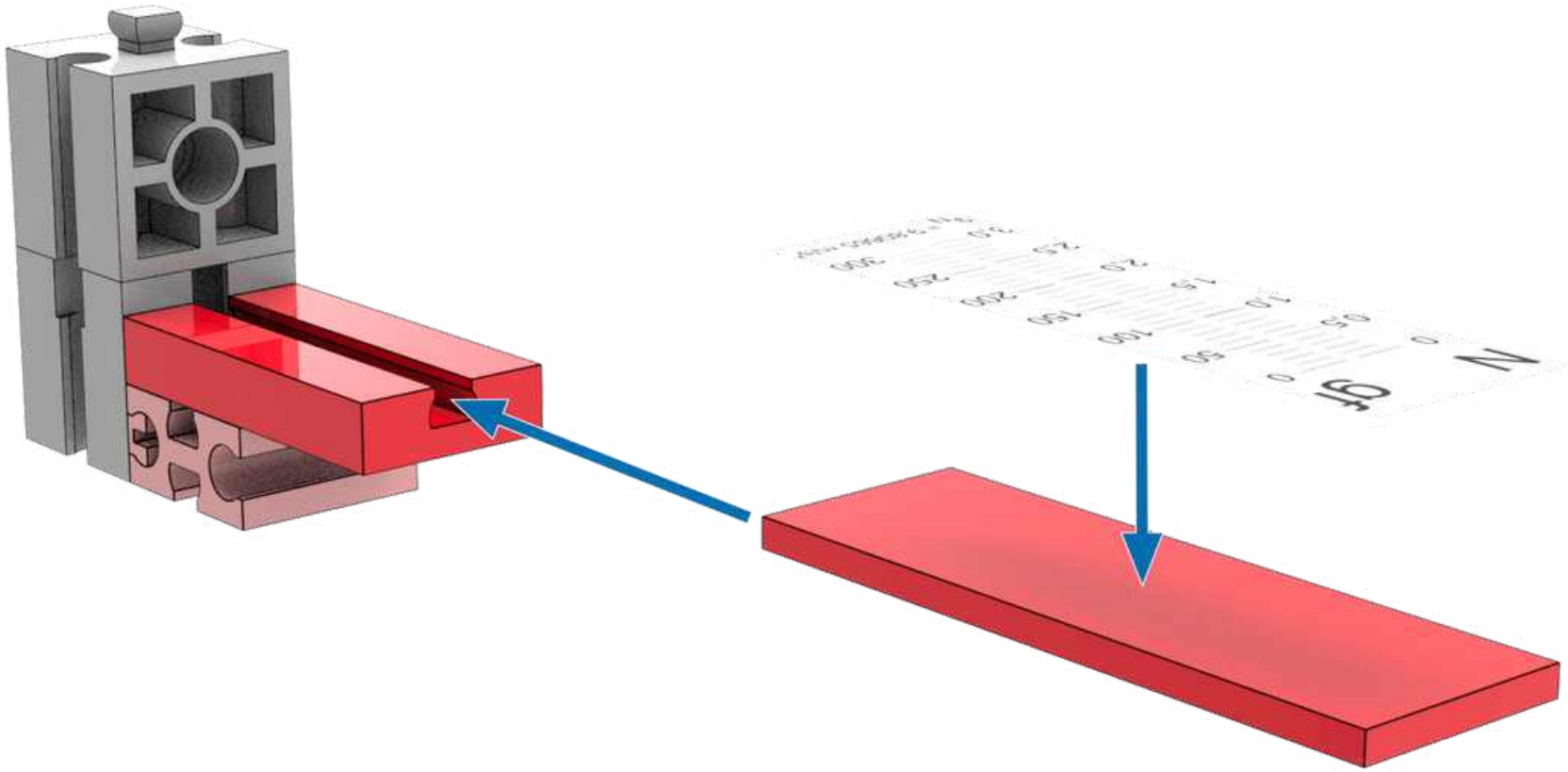

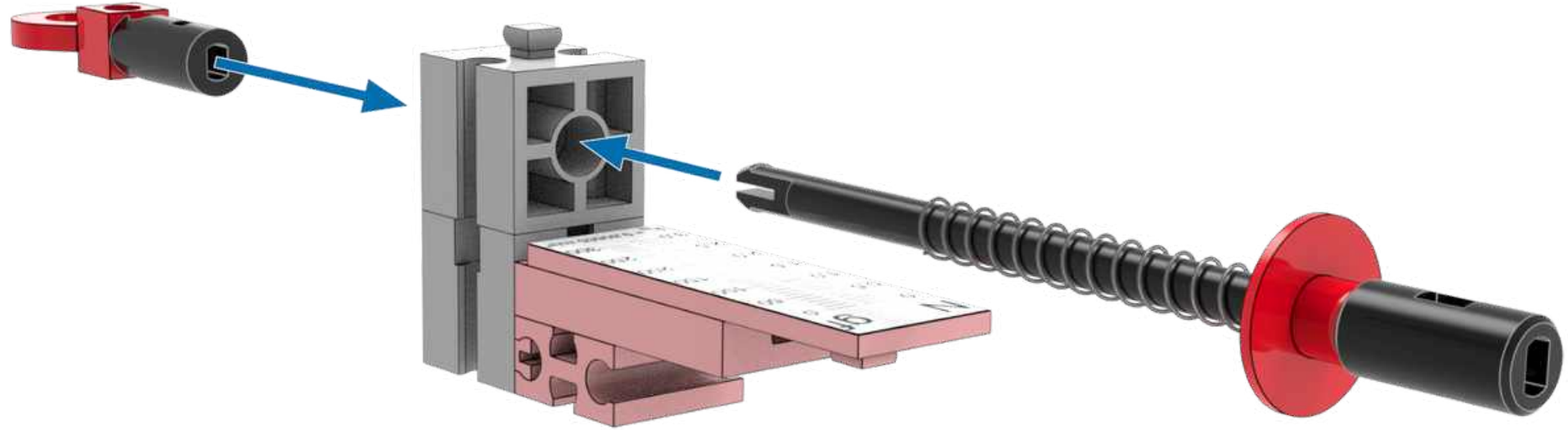

17 75 1x
1x
1x 1x 1x 1x

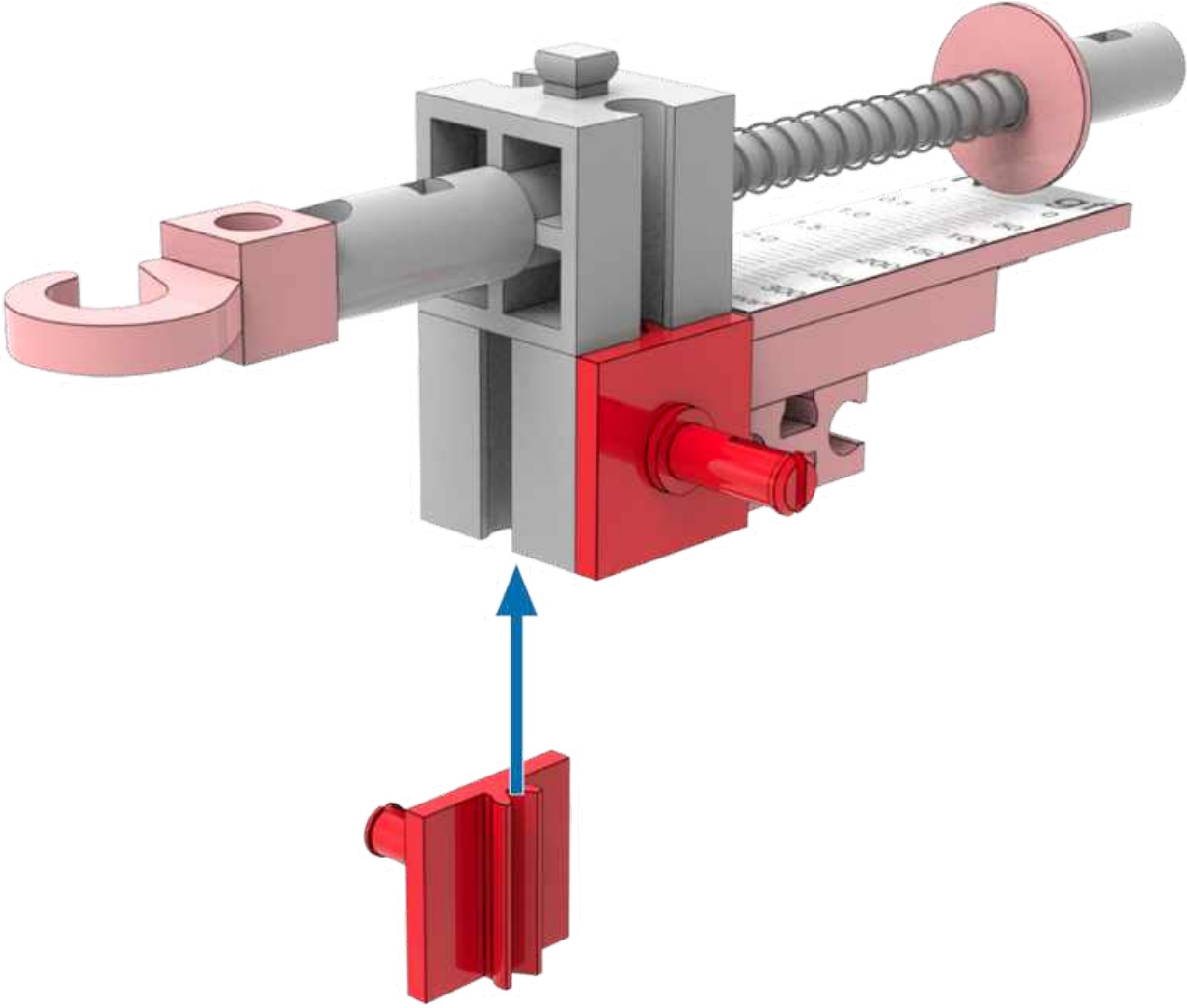

18  2x



19  2x  2x



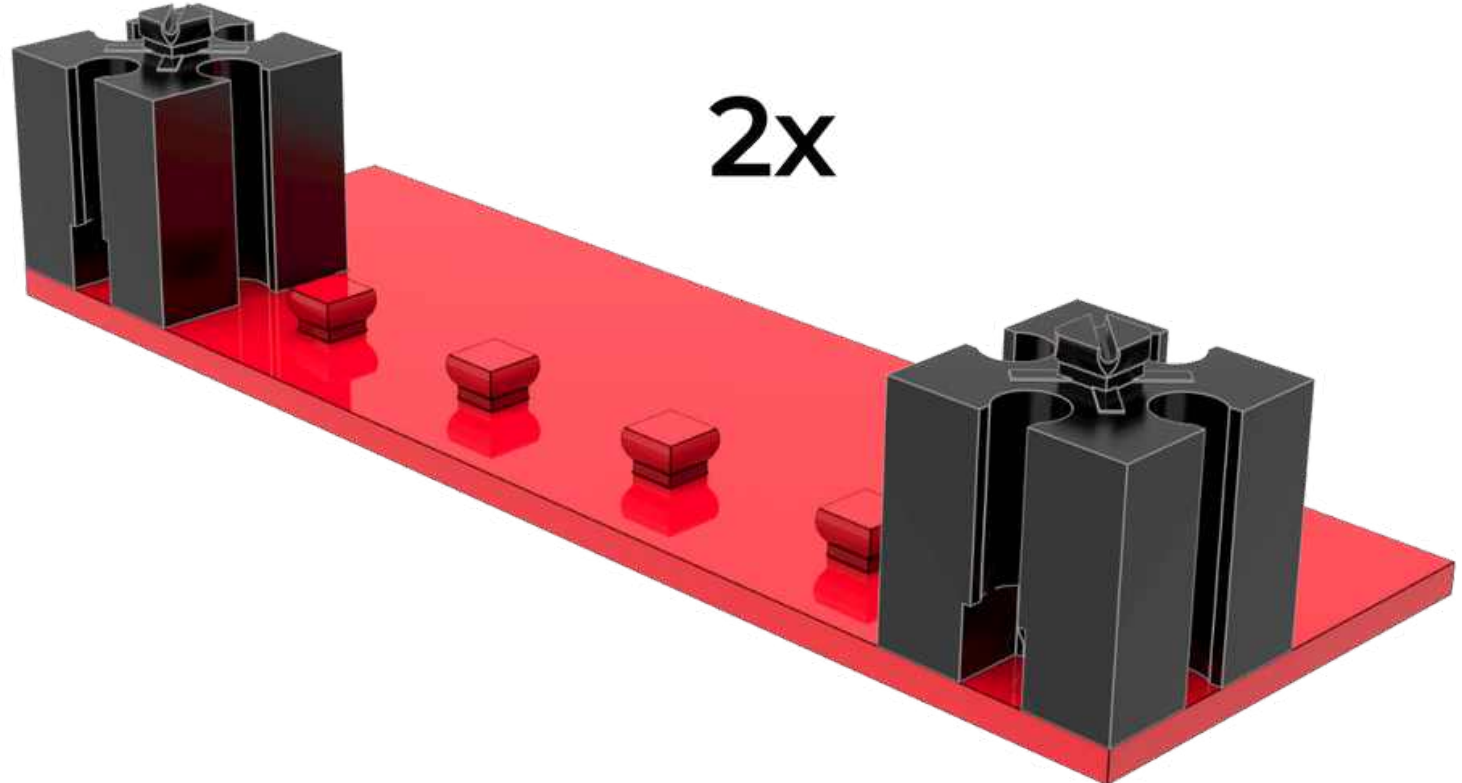
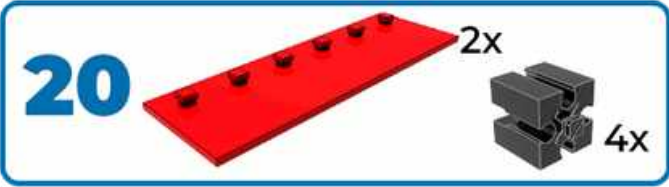

21 75 2x
4x

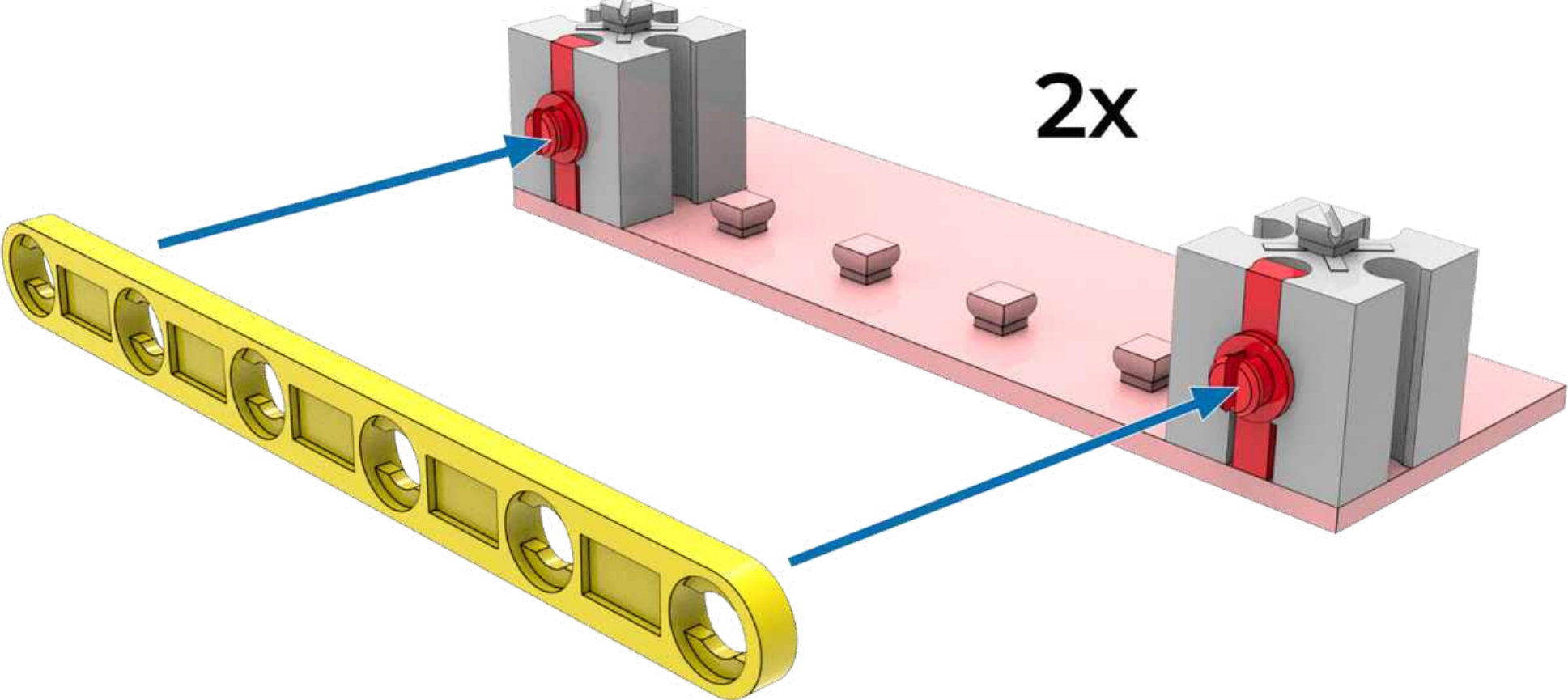

22  2x

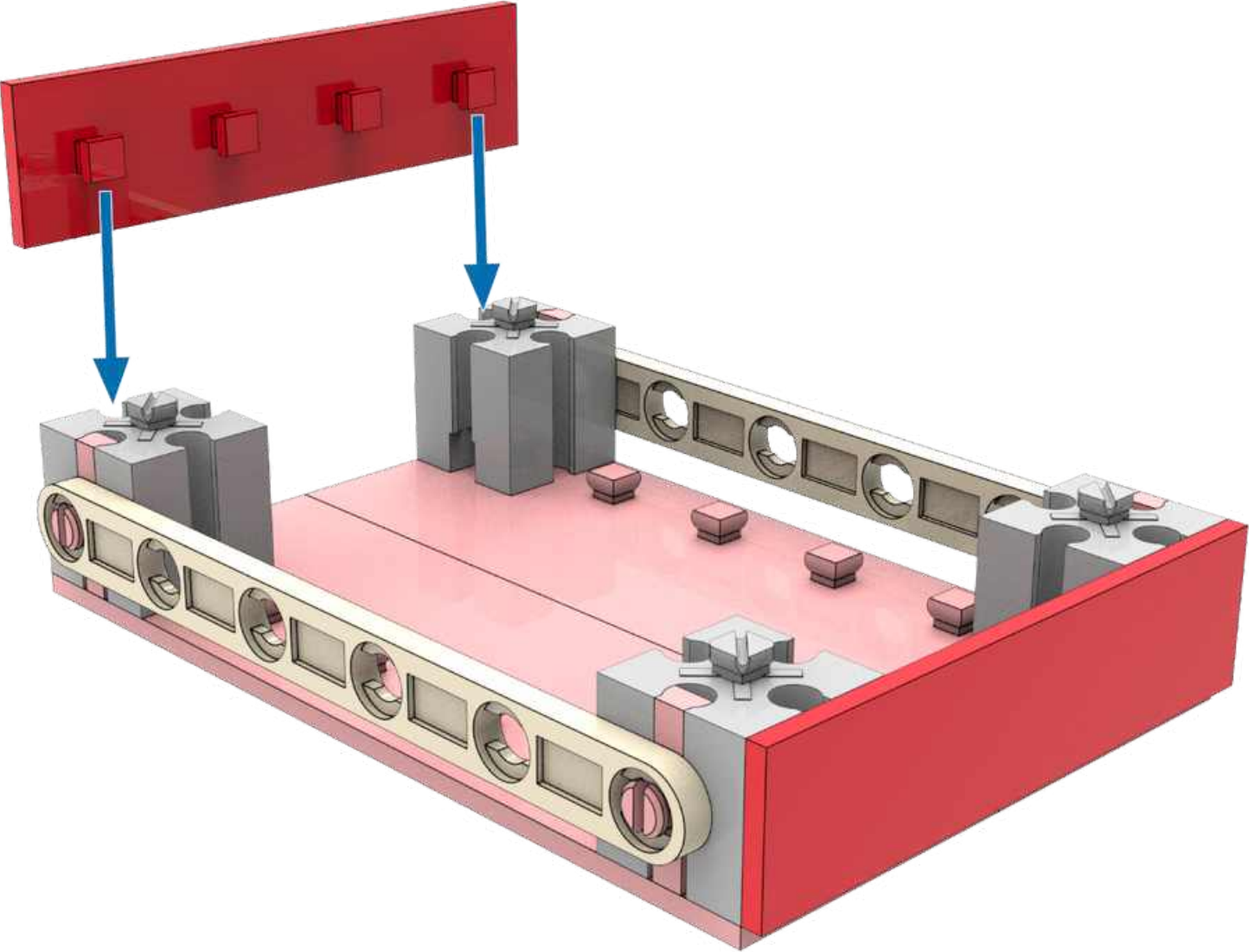

23  4x

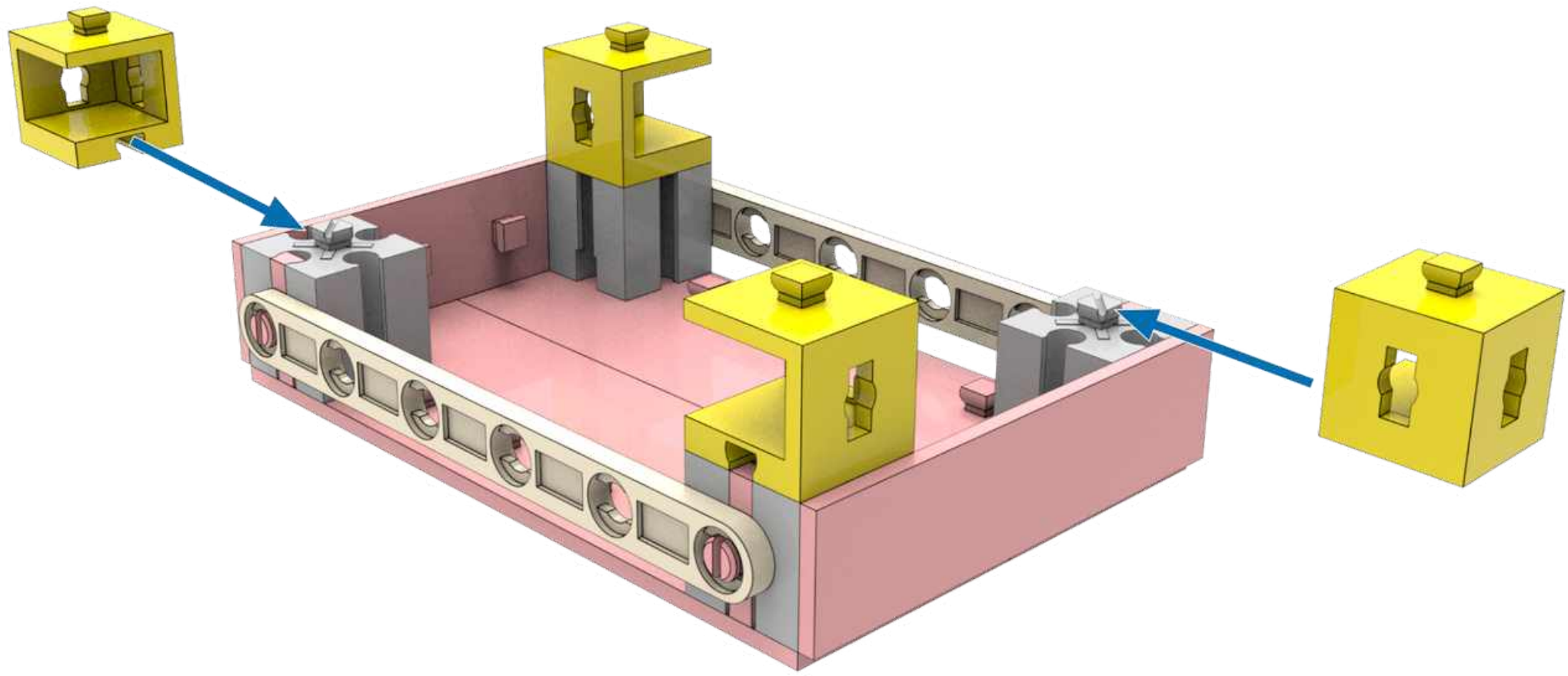

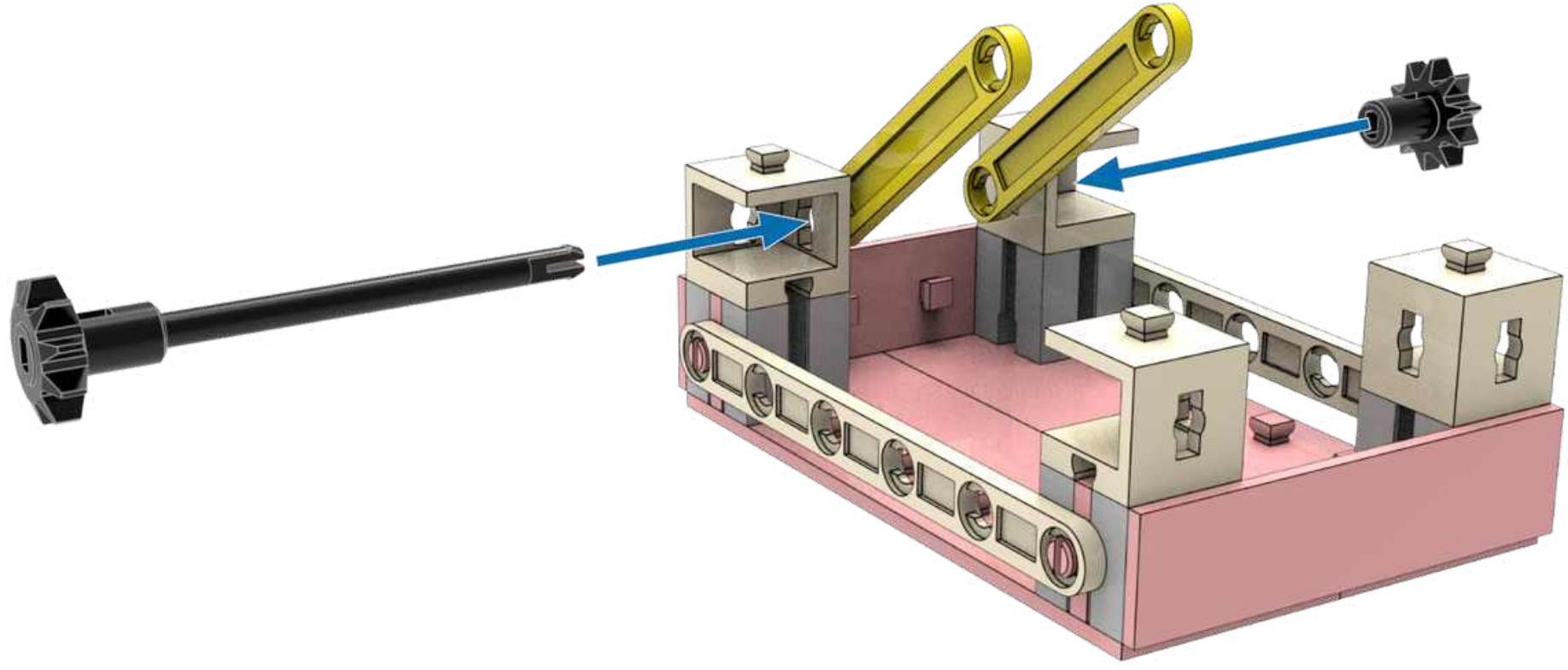

24 60 1x 42,4 2x  2x

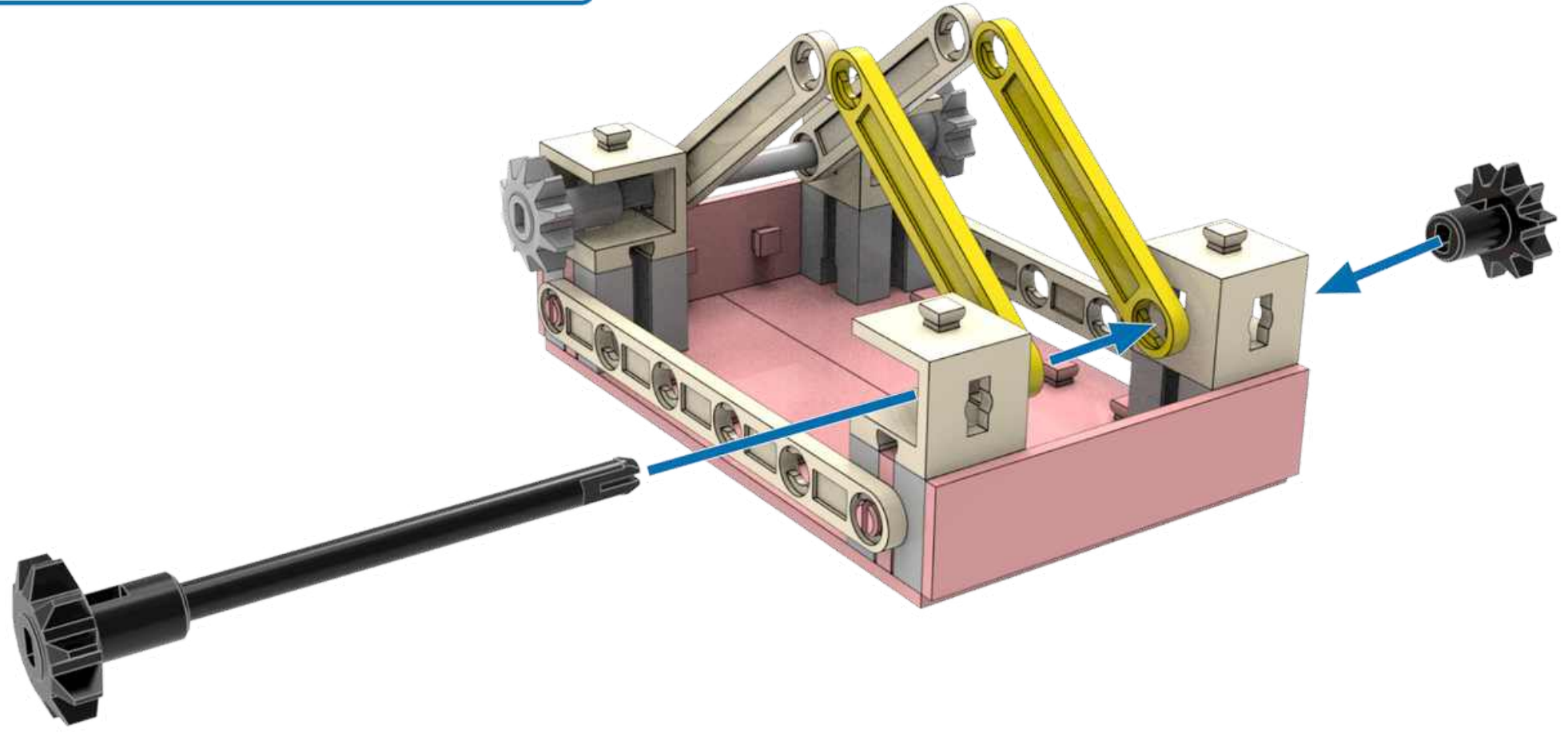

25 60 1x 42,4 2x  2x





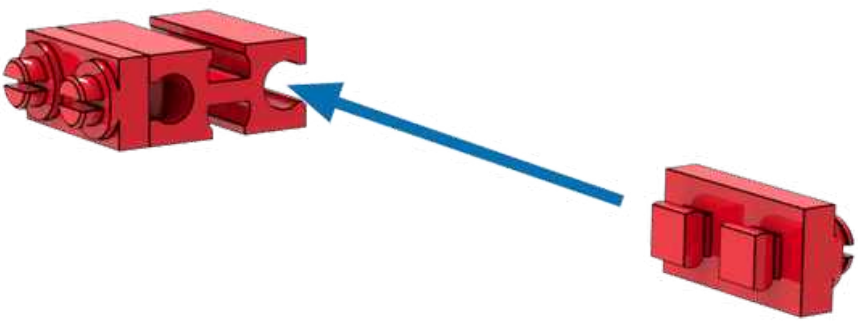

26  1x  2x

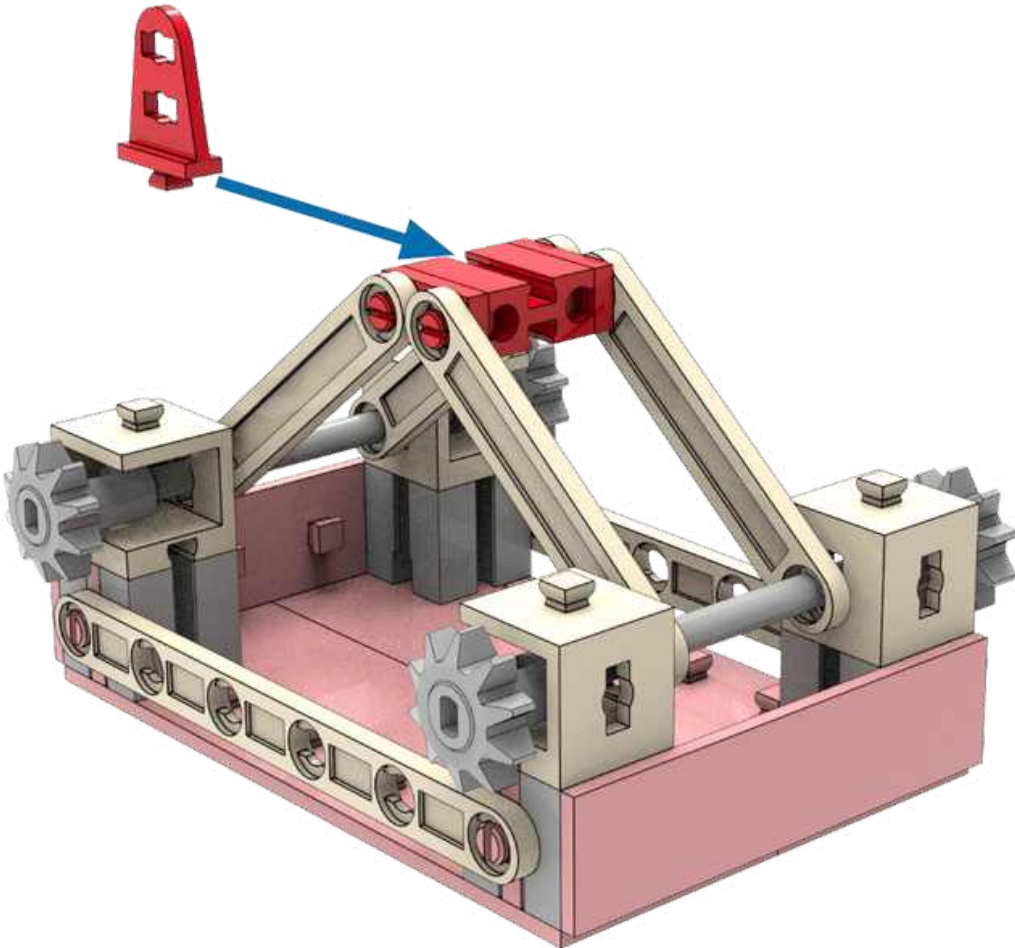



27  1x

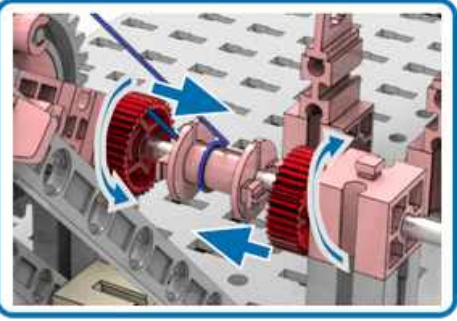
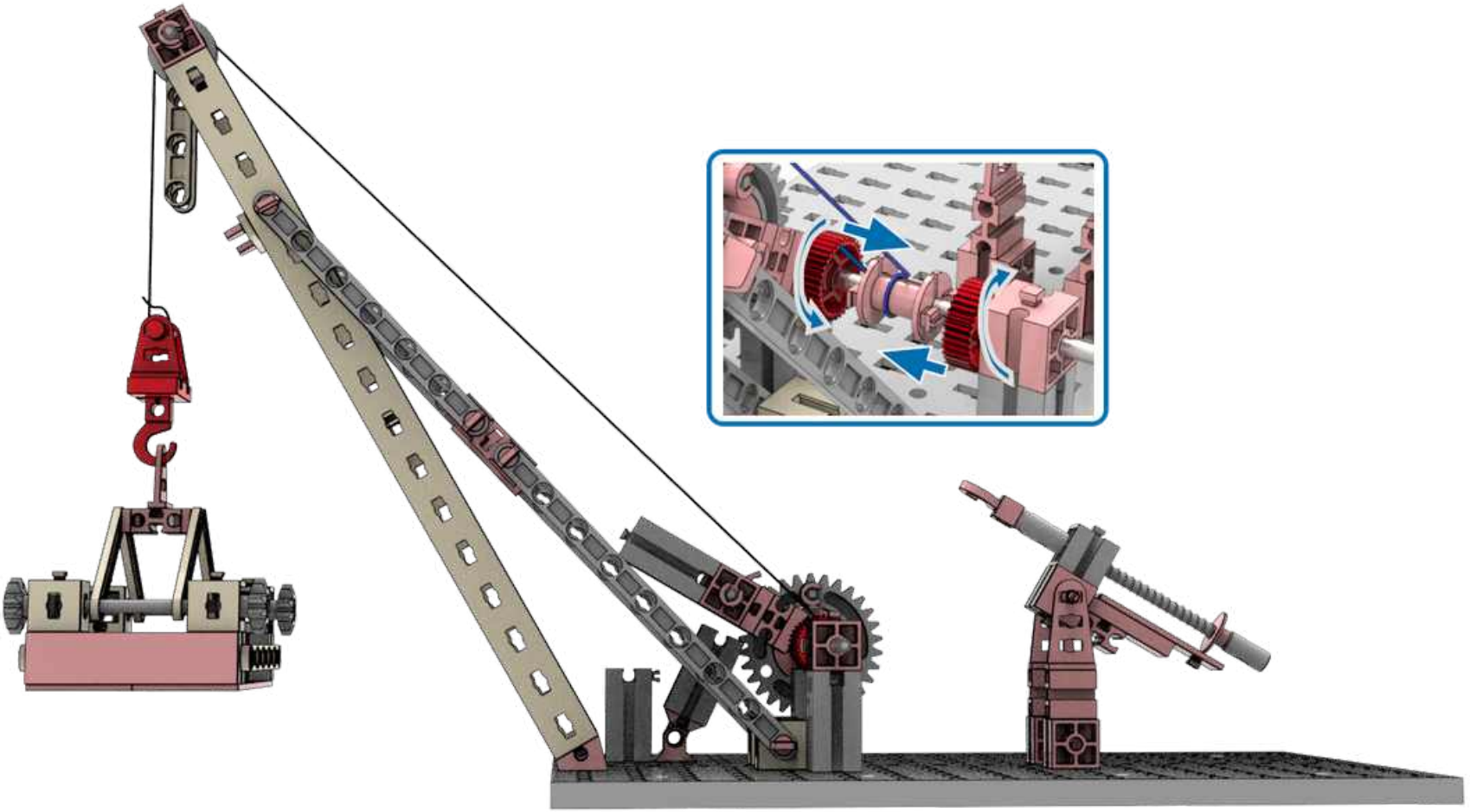
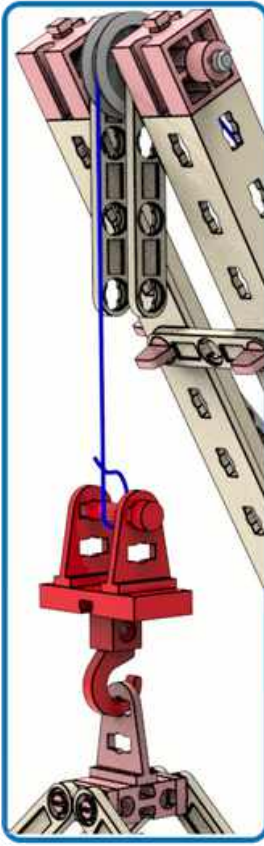

28  1x  1x  1x  2x  1x



29  1x  1x

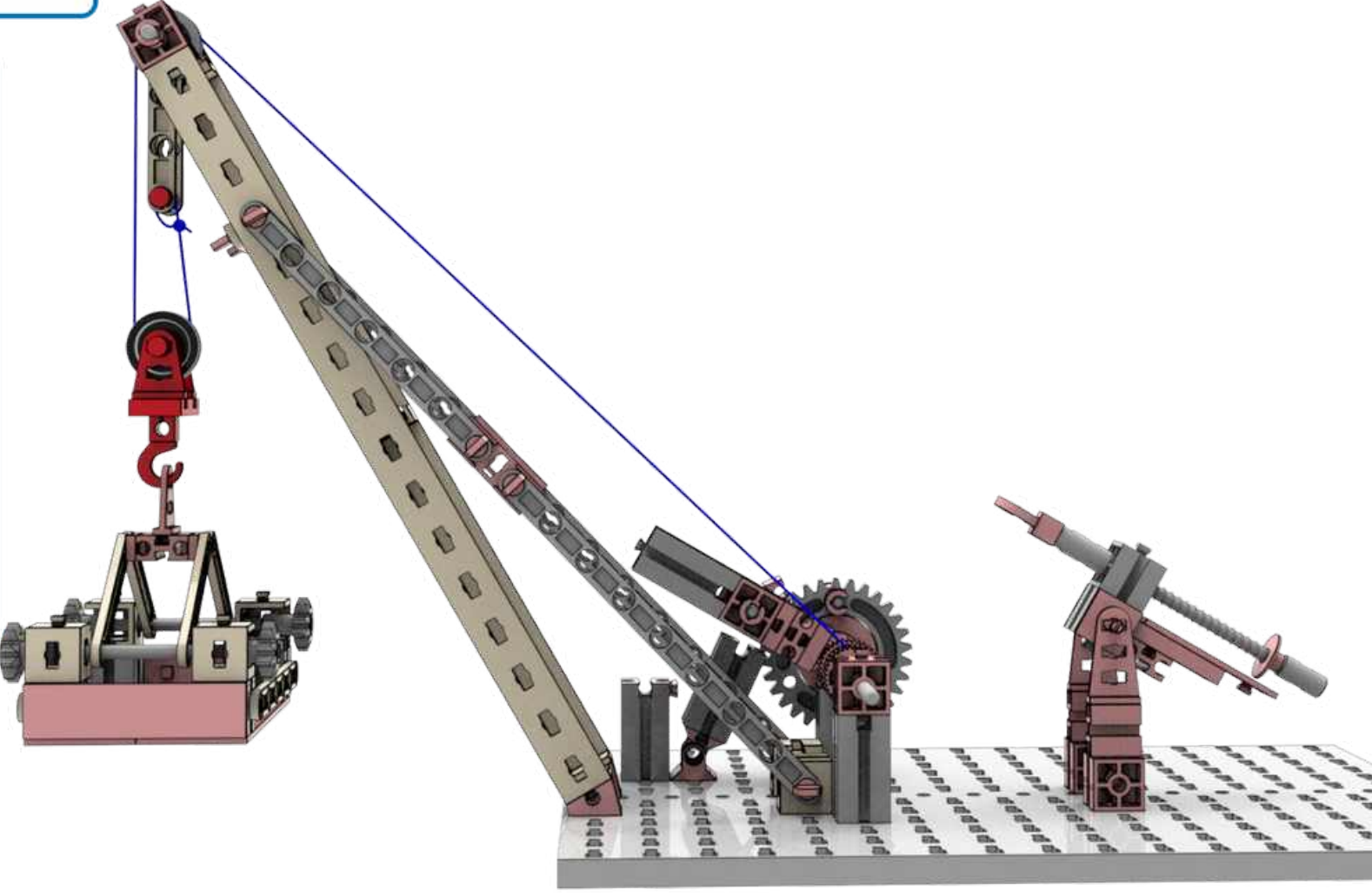
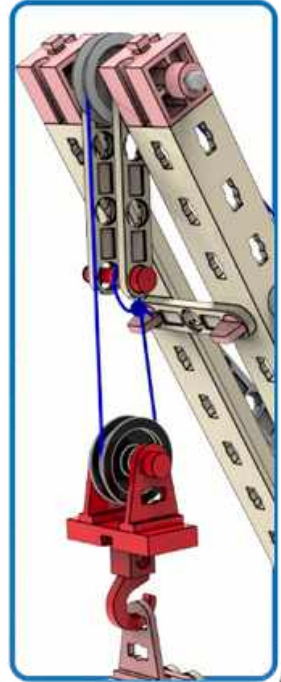

umbauen
modify
modifier
veranderen
modificar
modificar
modificare
переделать
改装



30  1x  1x  2x

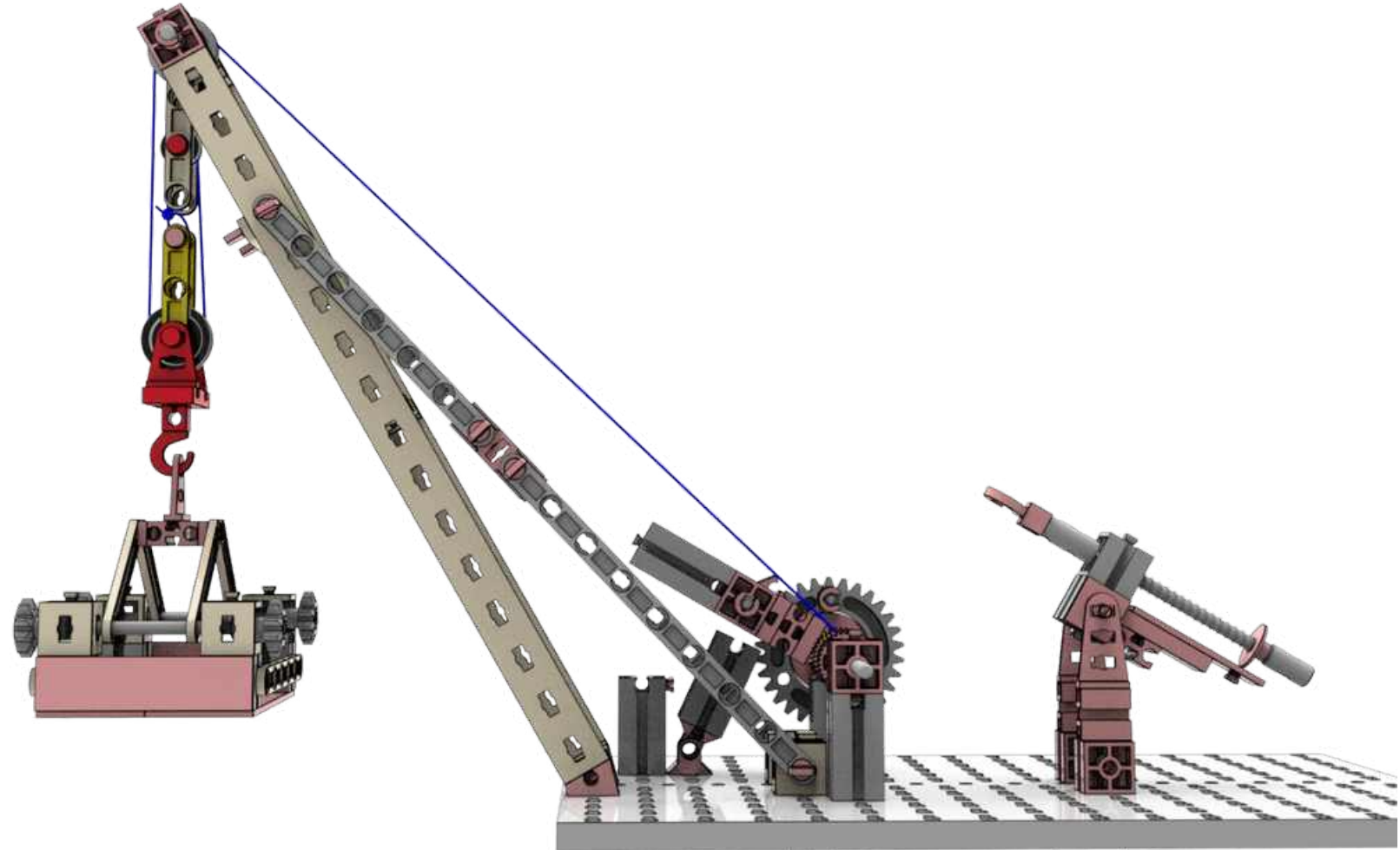
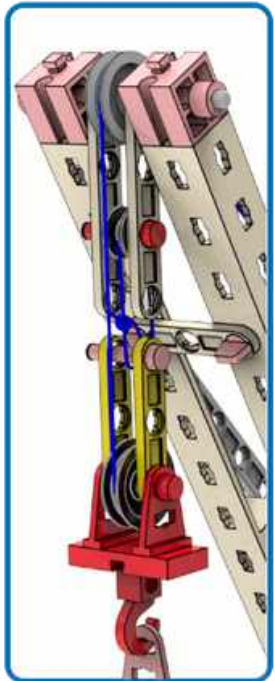

umbauen
modify
modifier
veranderen
modificar
modificar
modificare
переделать
改装

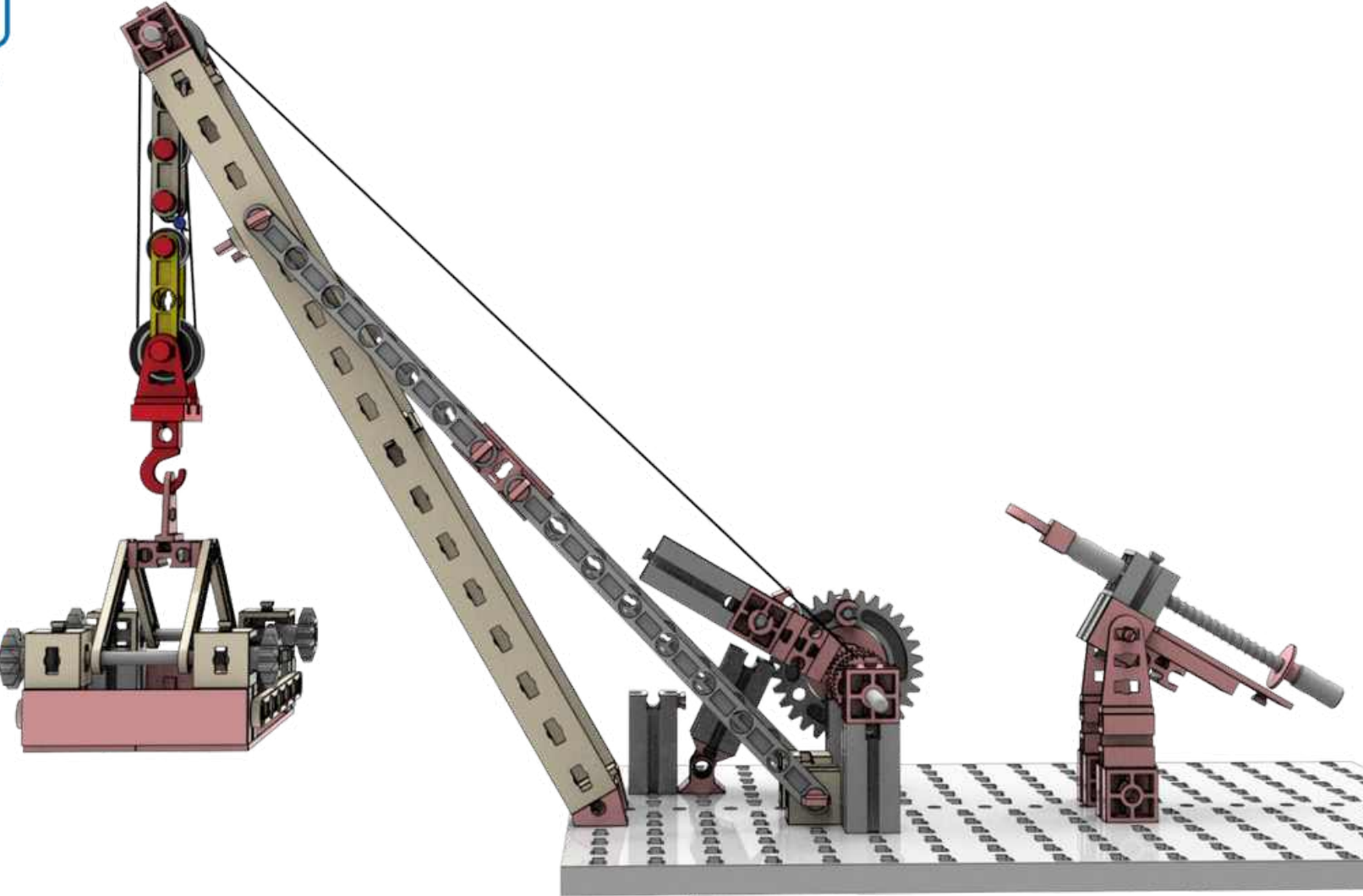
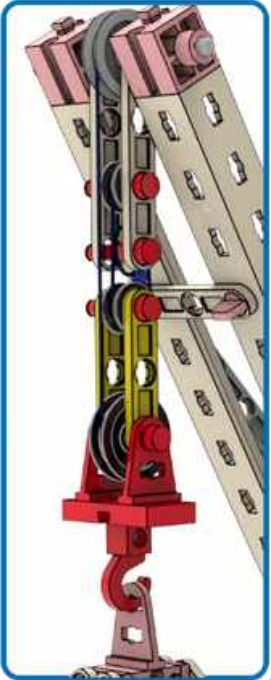

31  1x  1x

umbauen
modify
modifier
veranderen
modificar
modificar
modificare
переделать
改装



32  1x  1x  2x

umbauen
modify
modifier
veranderen
modificar
modificar
modificare
переделать
改装

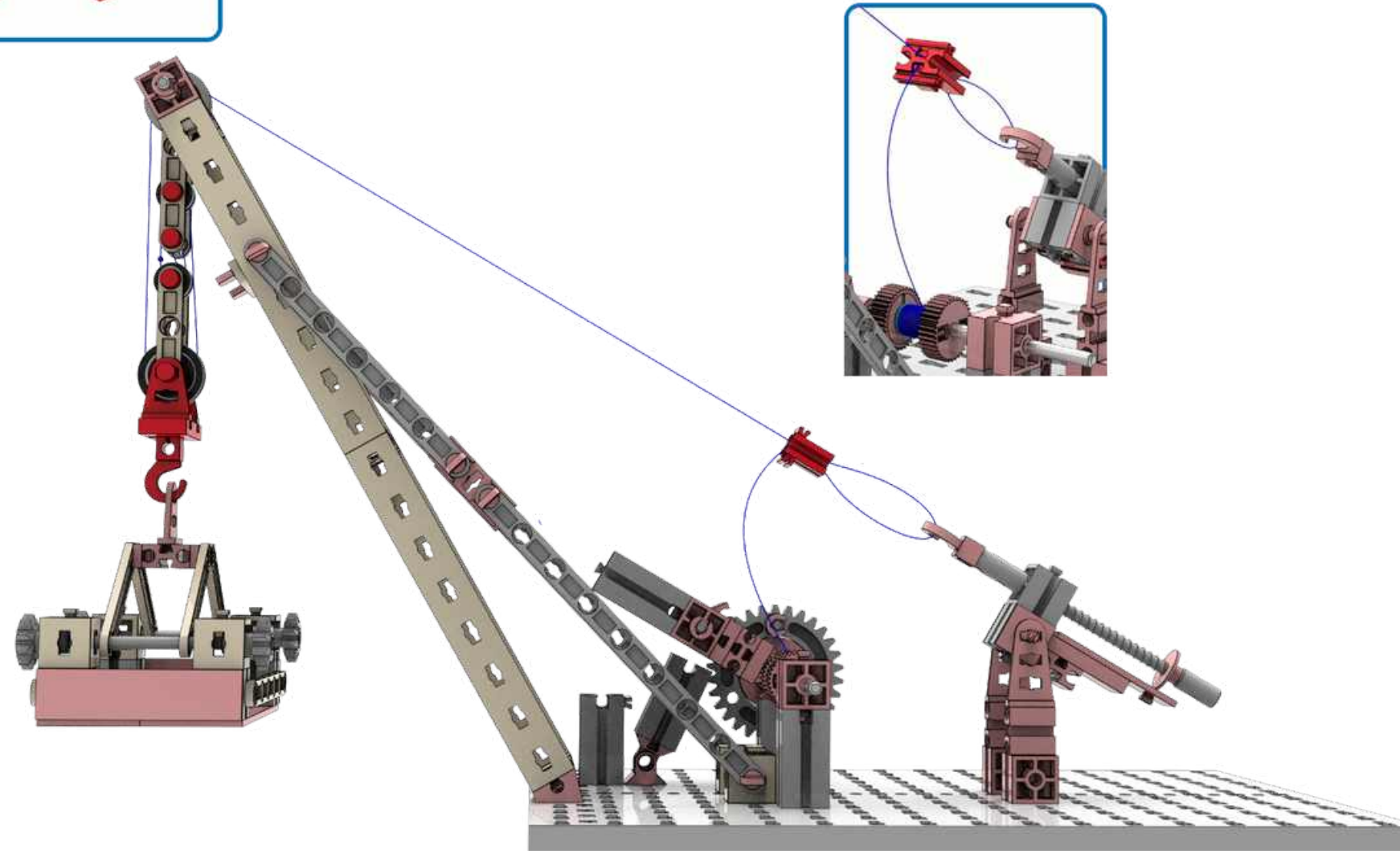



Schiefe Ebene



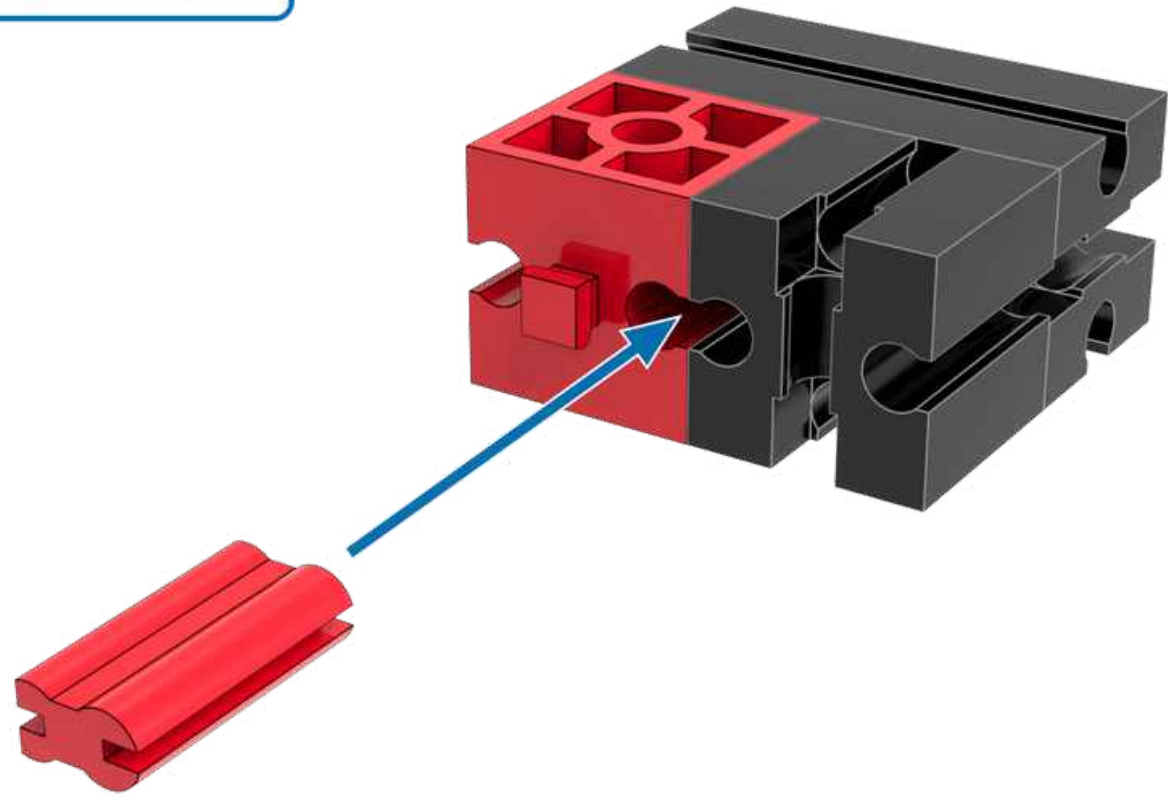
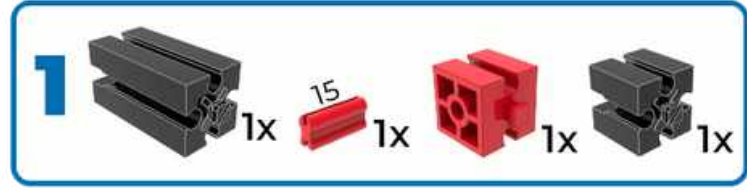





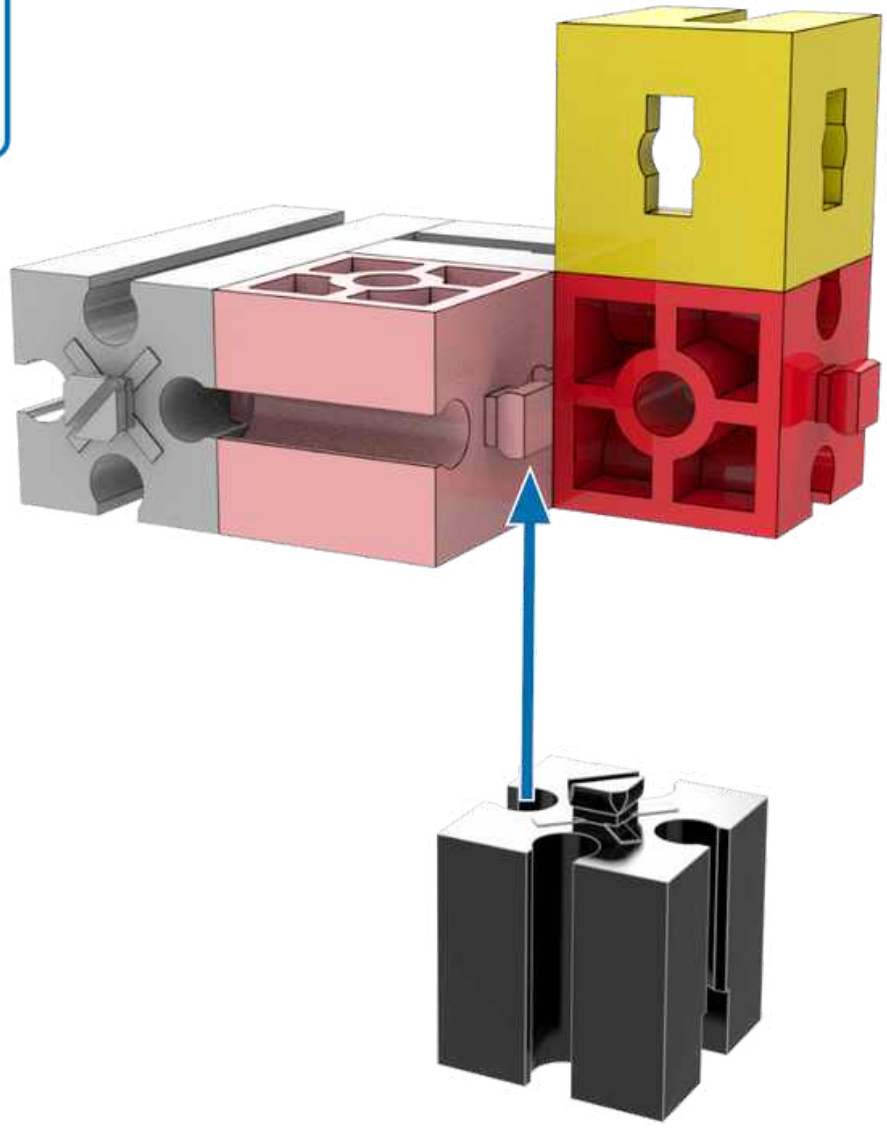

2  1x  1x  1x

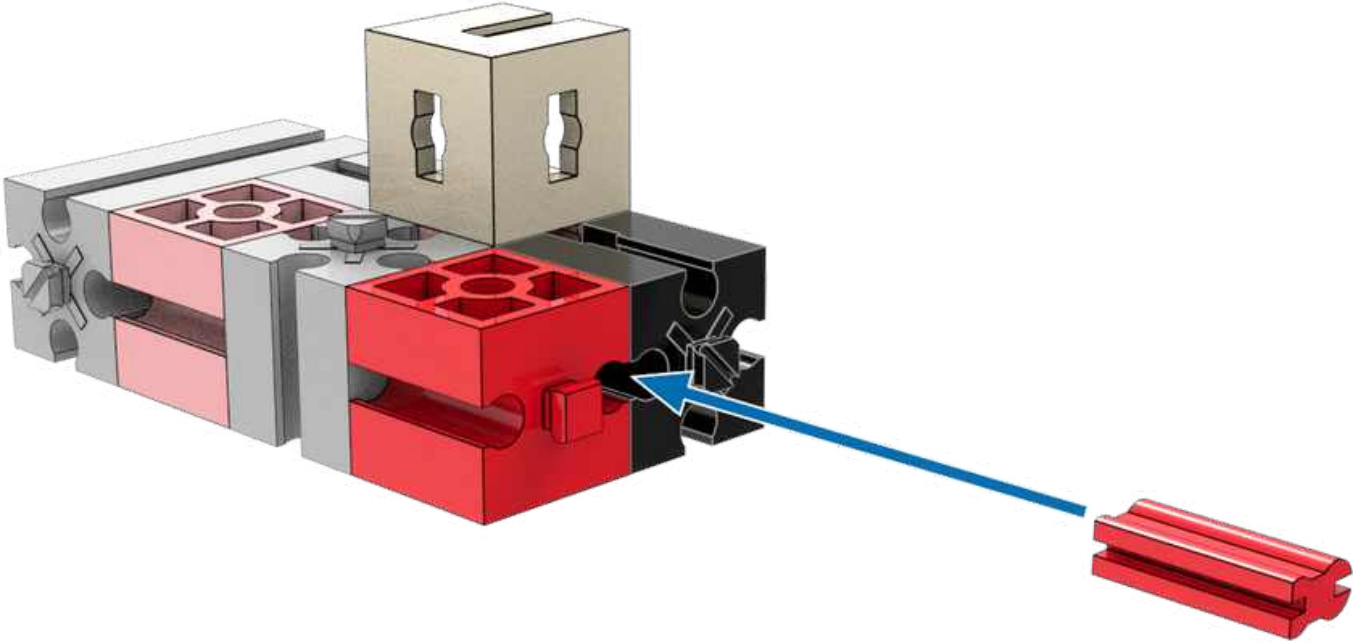

3  1x  1x  1x

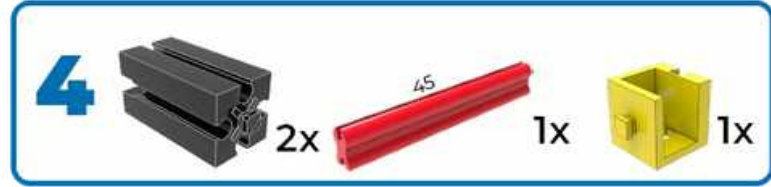





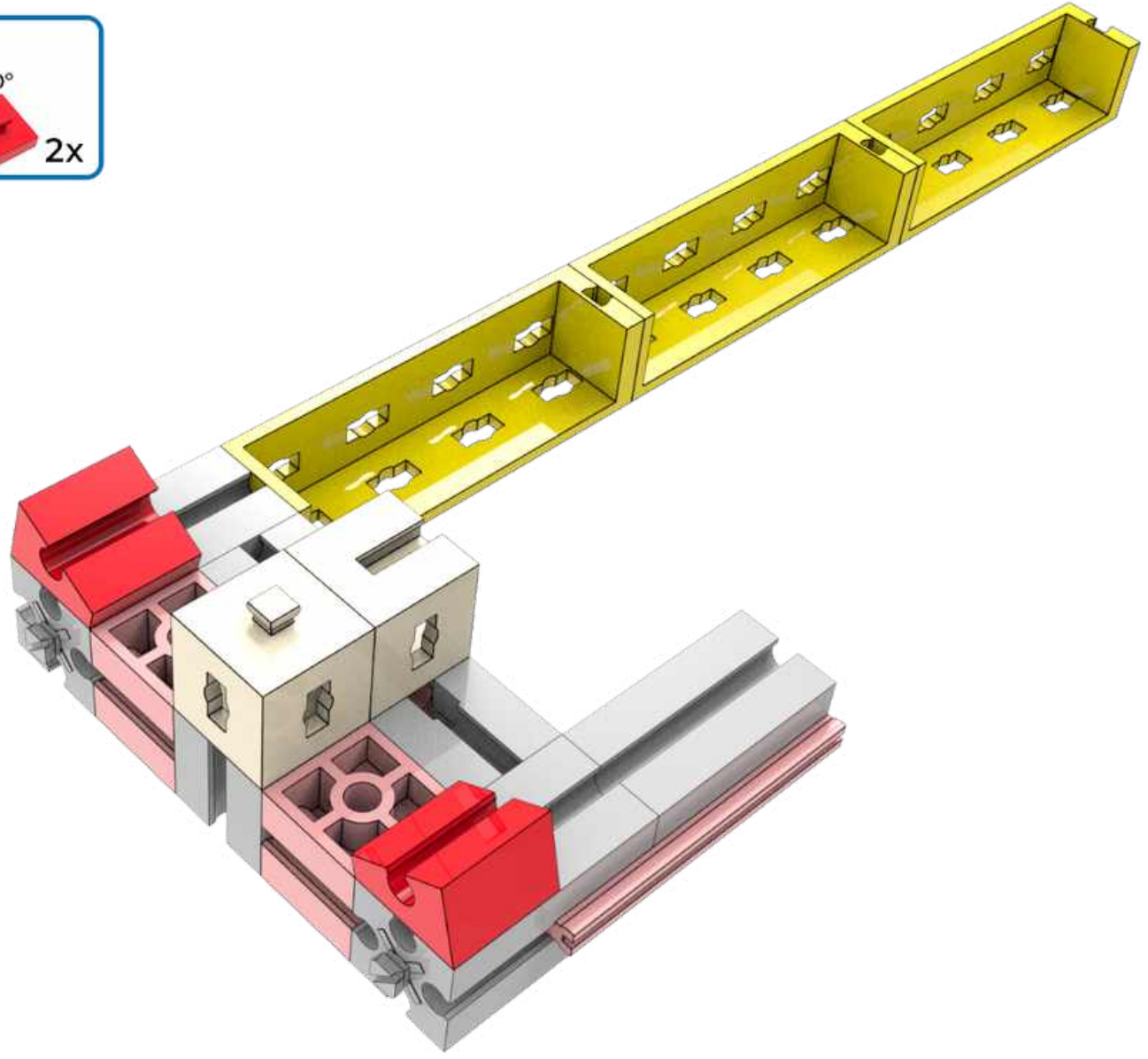

5  3x  30° 2x

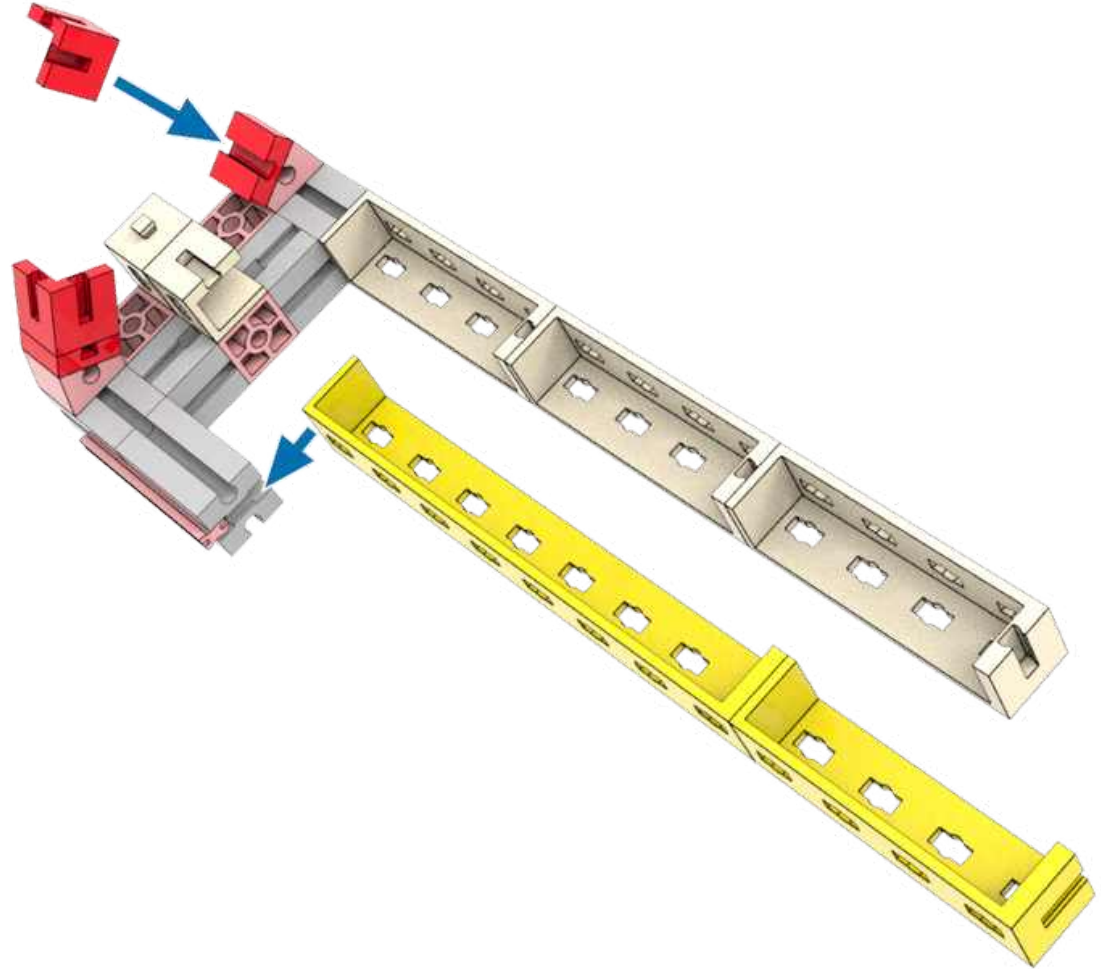



6  1x  1x  2x  2x

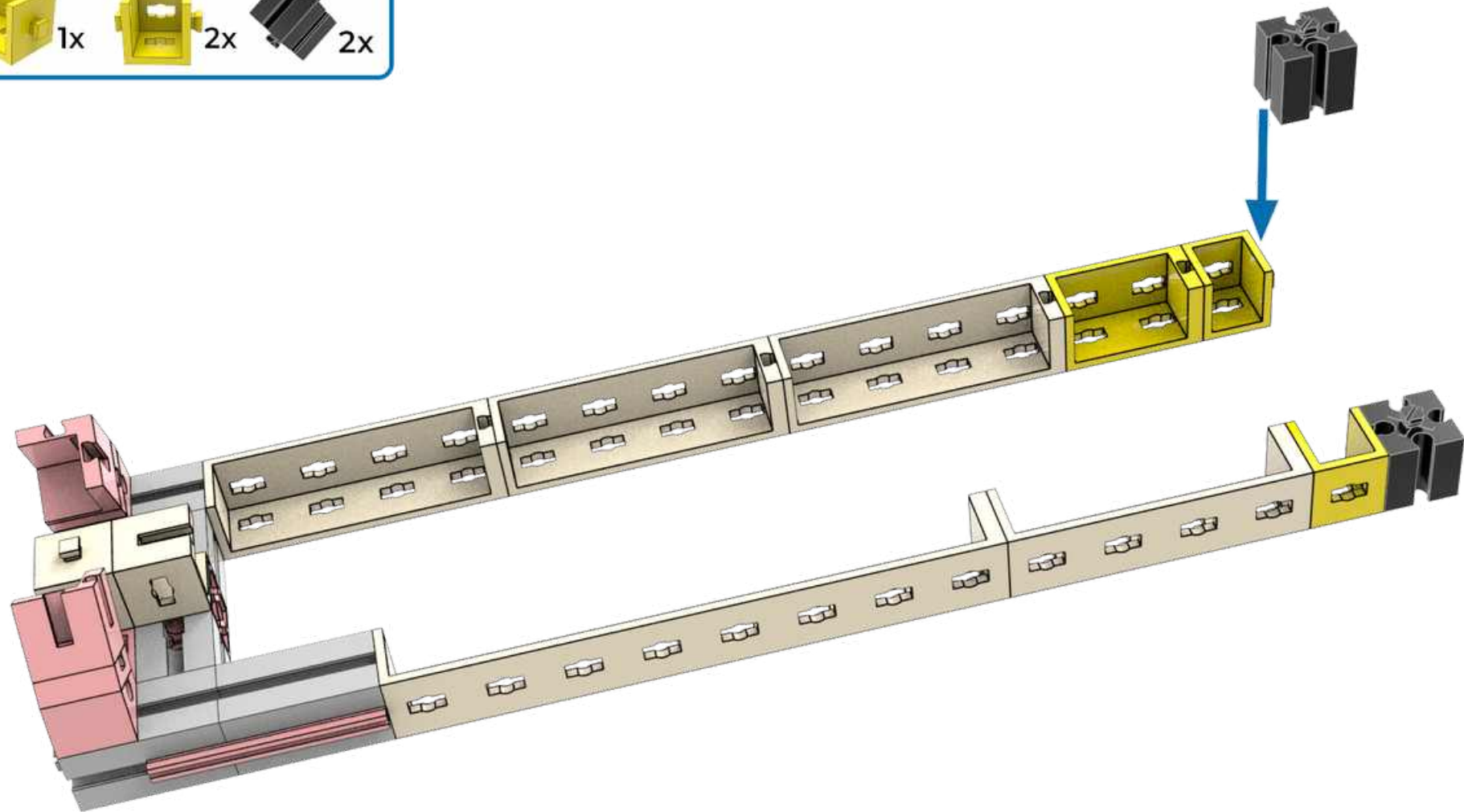

7  1x  2x  2x



8  1x  1x  2x

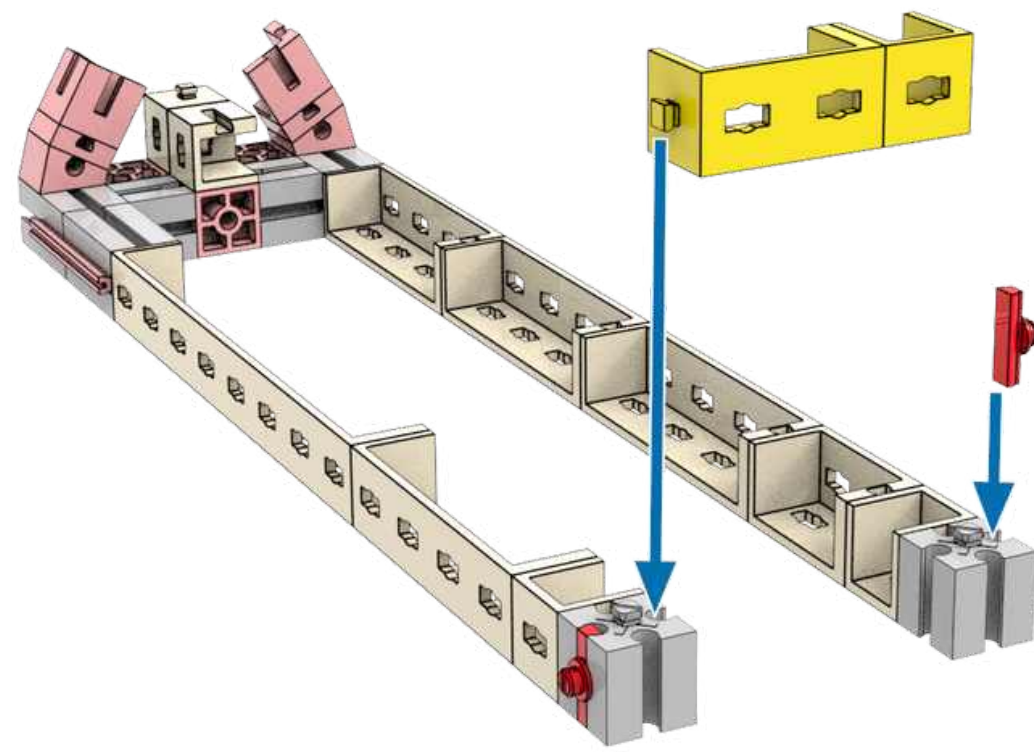

9  4x  2x

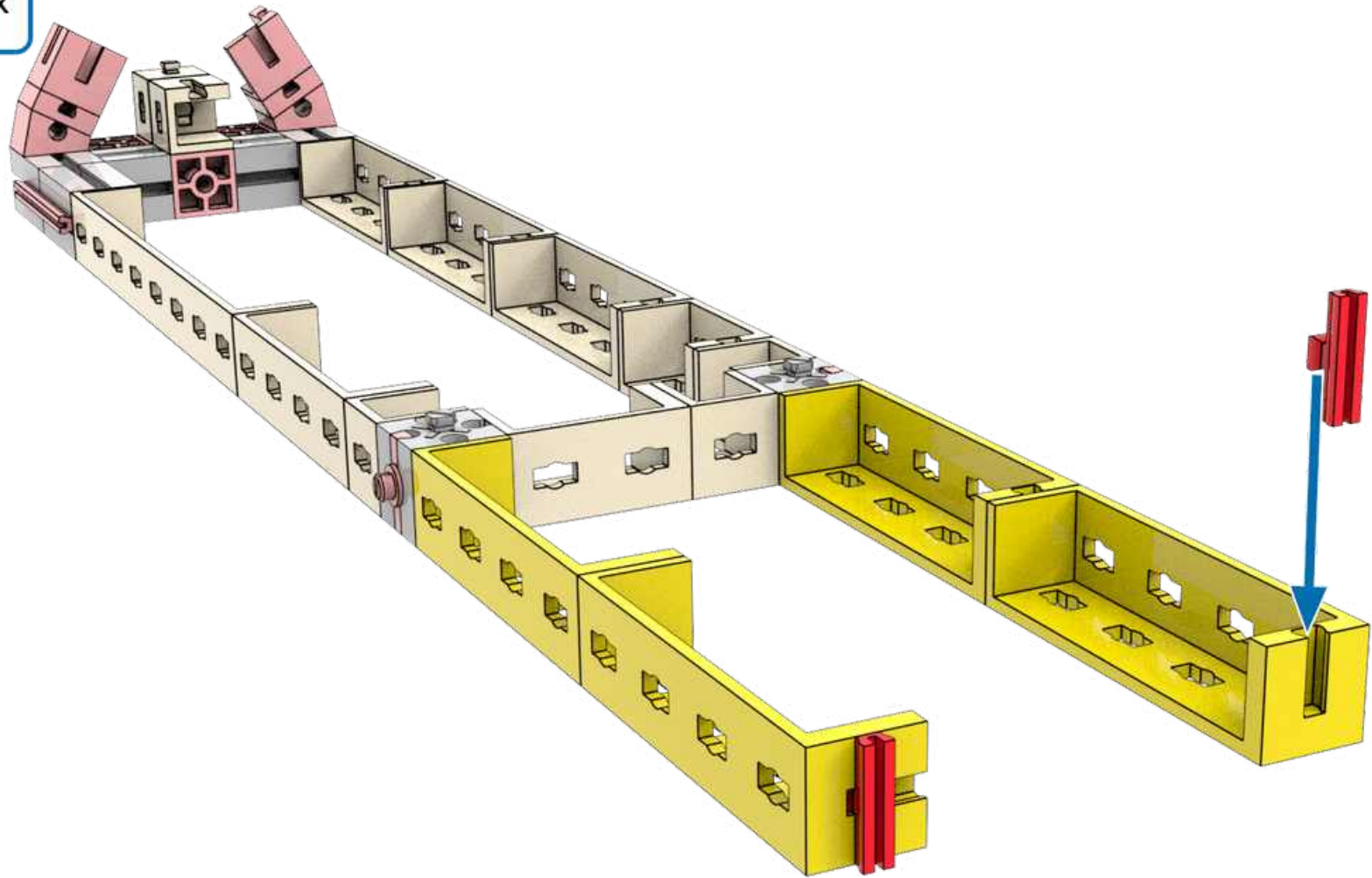

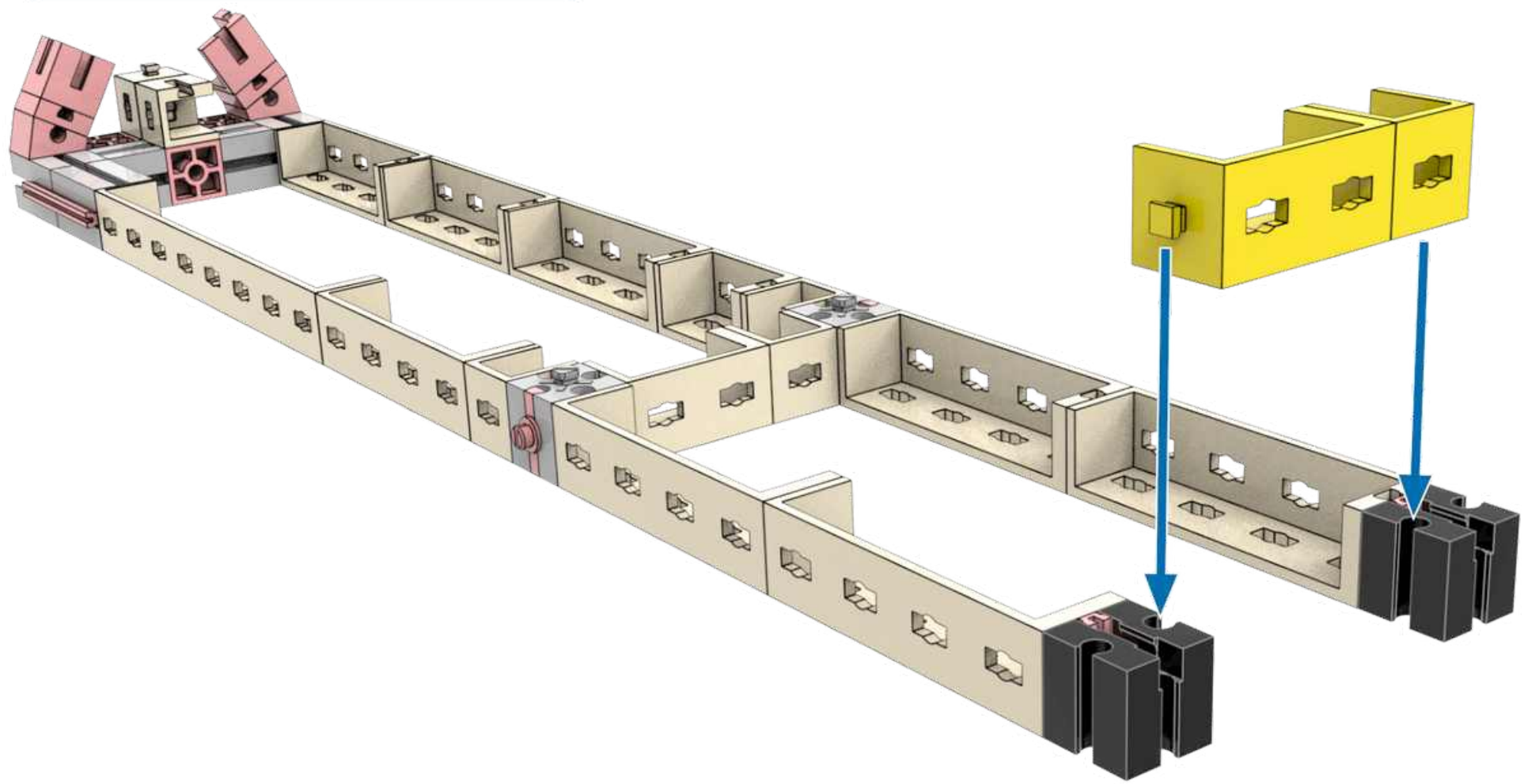

10  2x  1x  1x

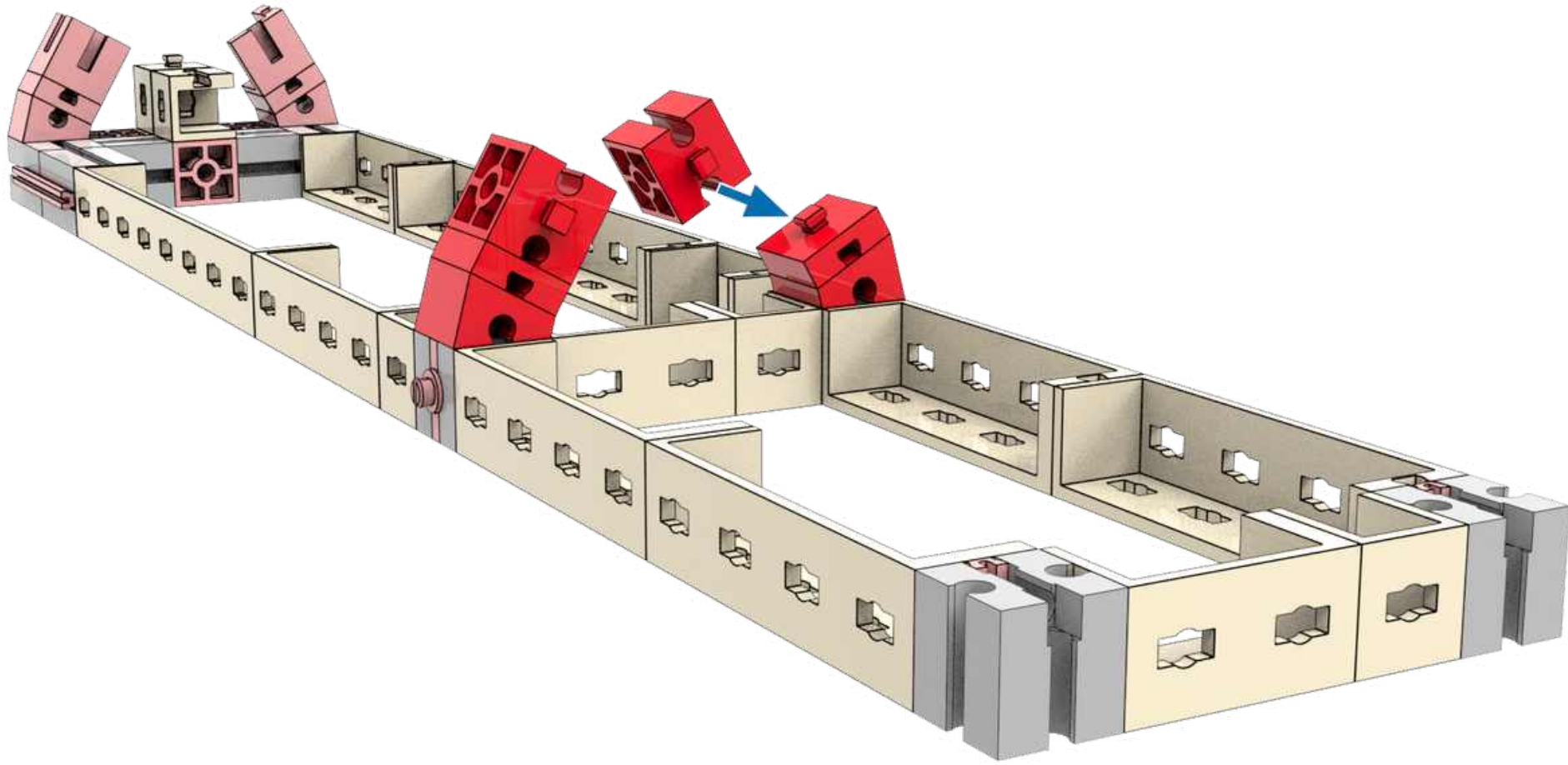

11 ^{30°} 2x 2x 2x



12 ^{30°} 2x  2x  2x  2x

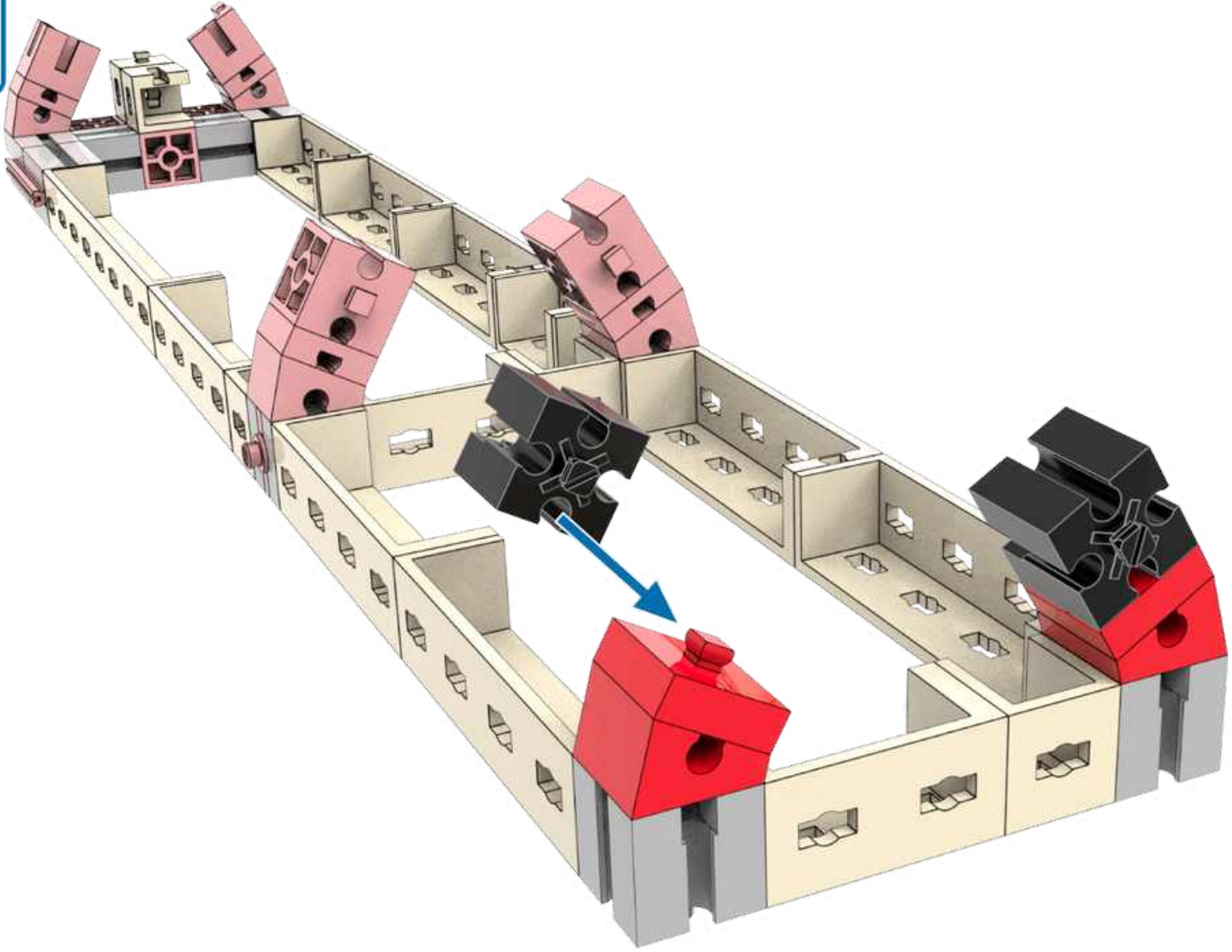

13



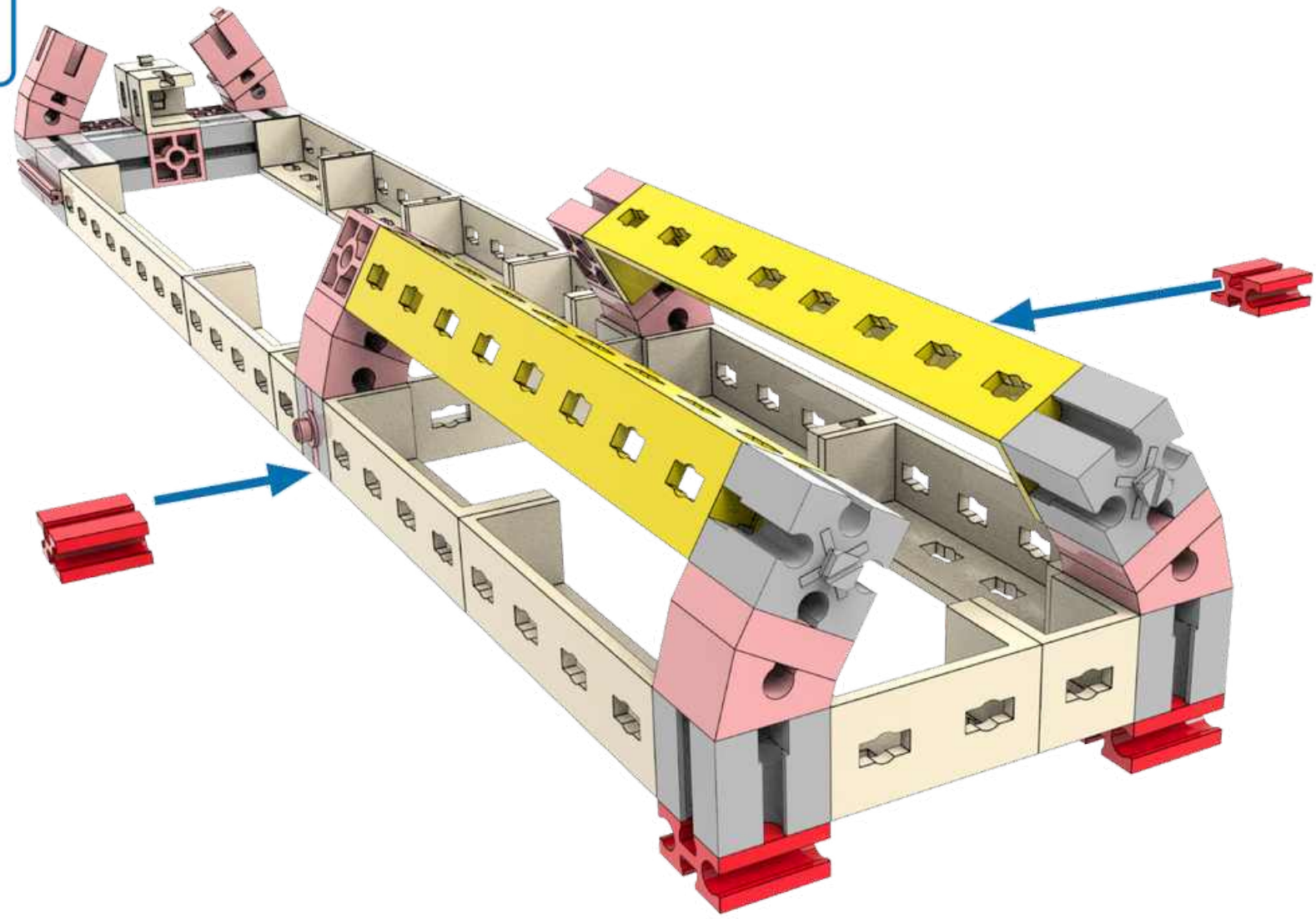

2x
4x



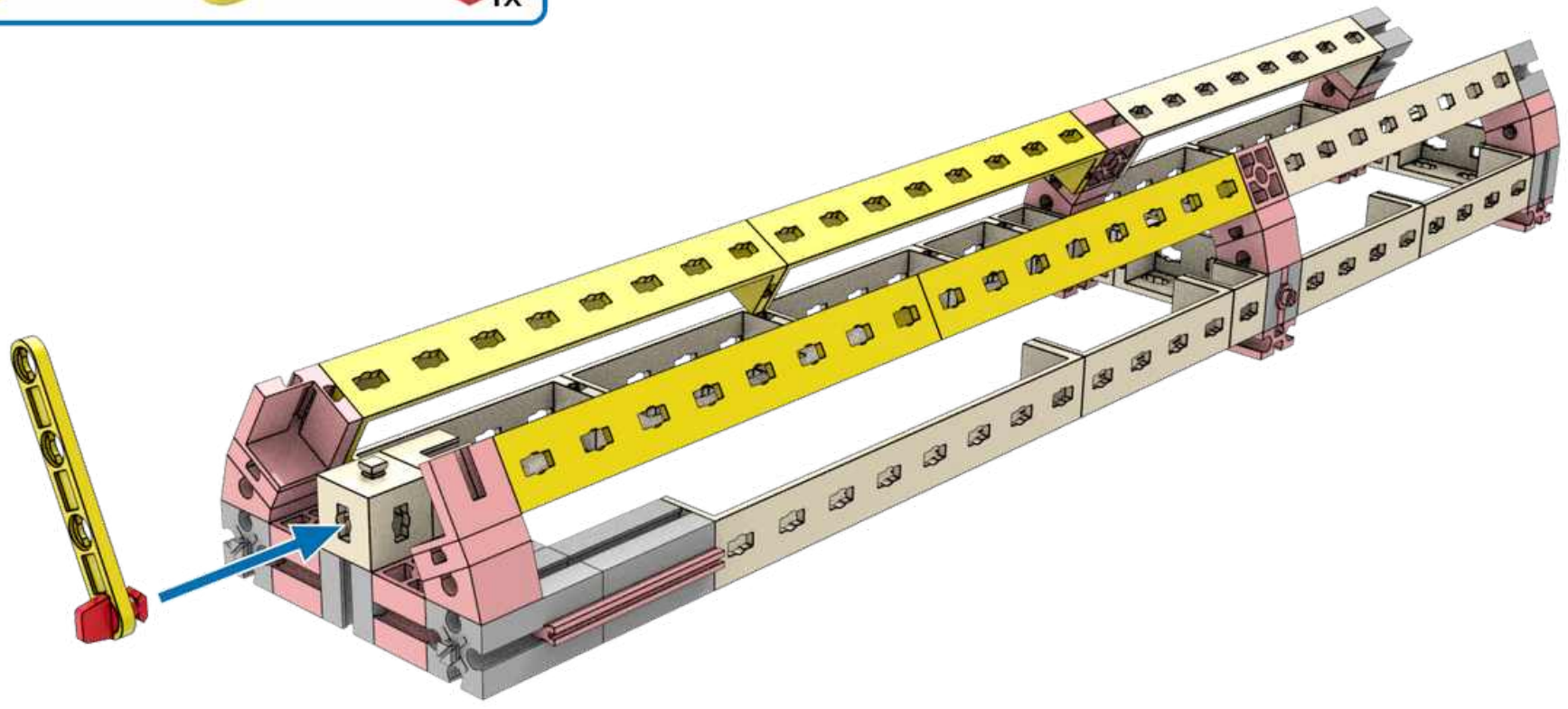

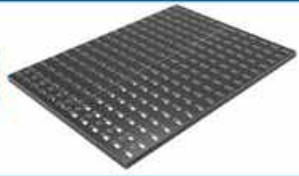
14 4x 45 1x 4 1x

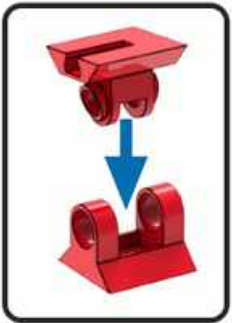
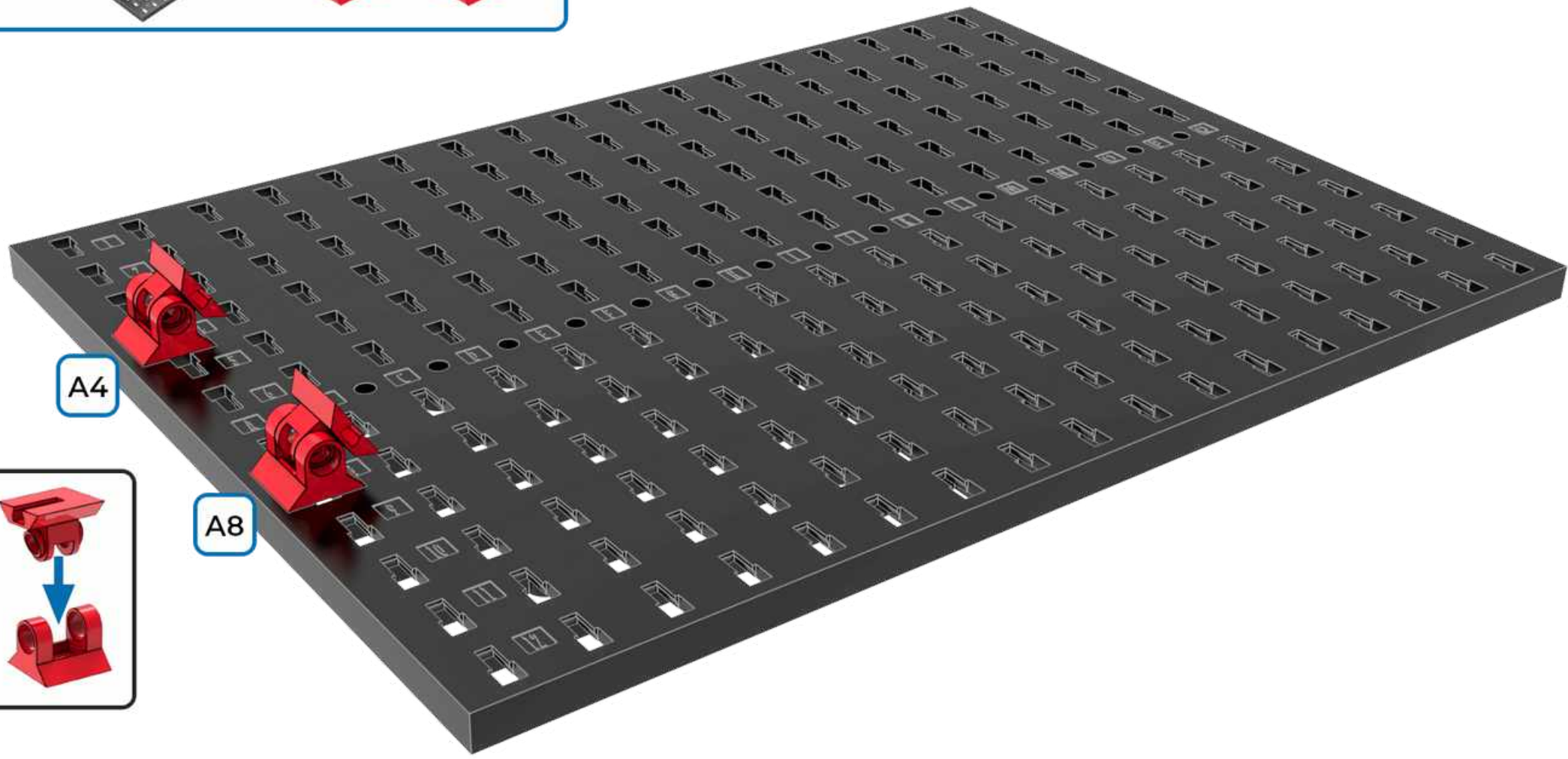

15  1x  2x  2x





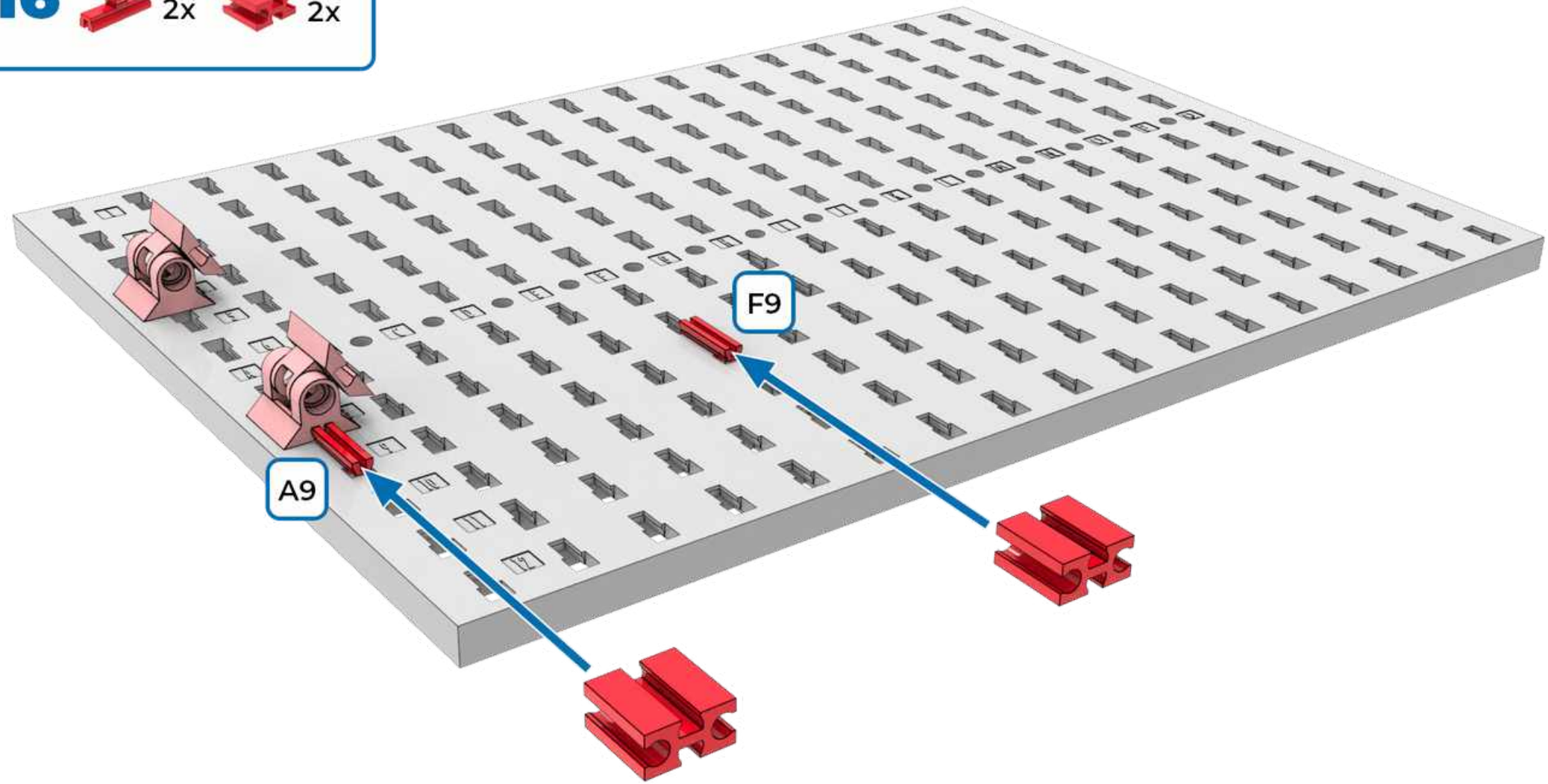

16  2x  2x

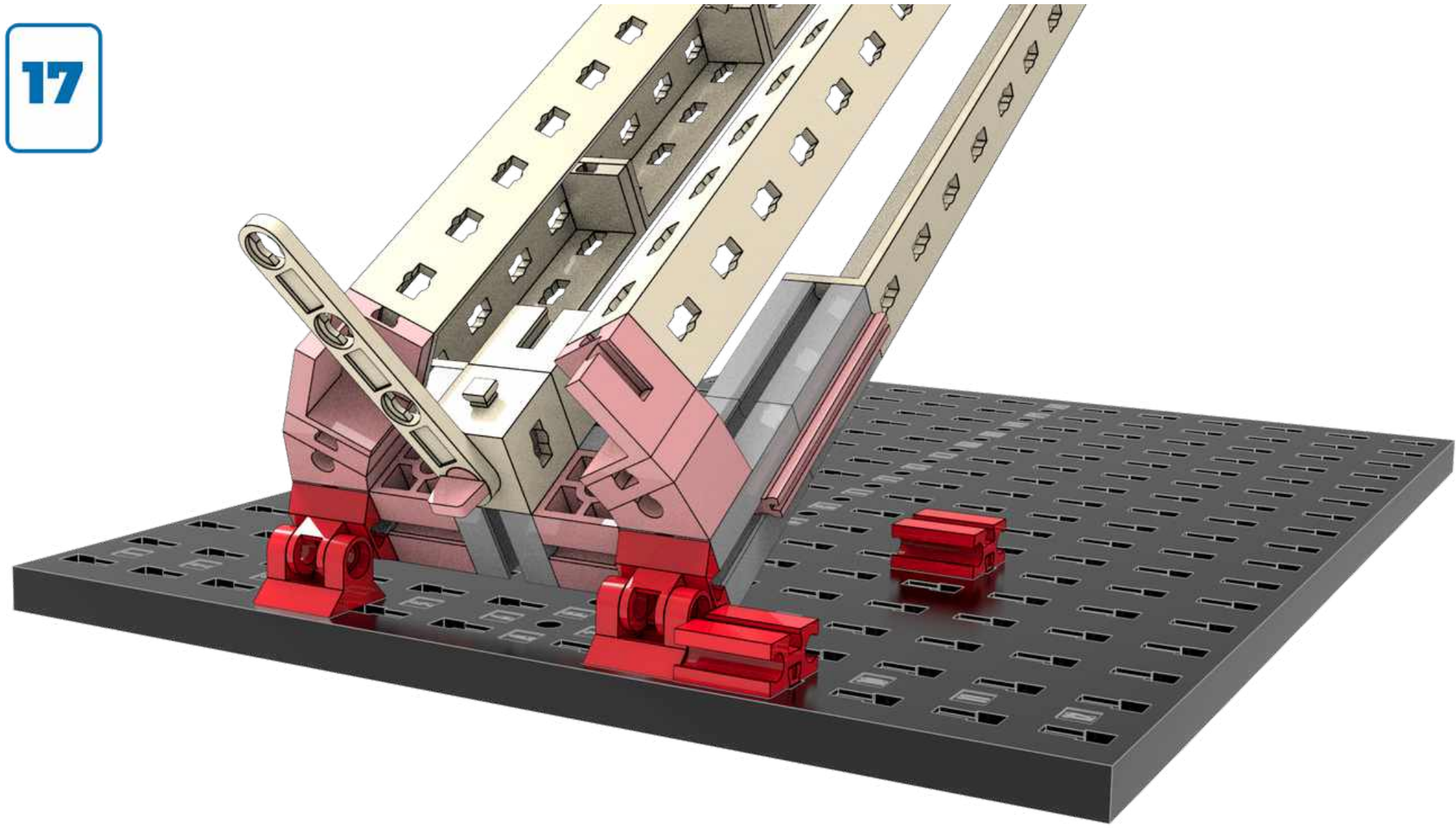





17

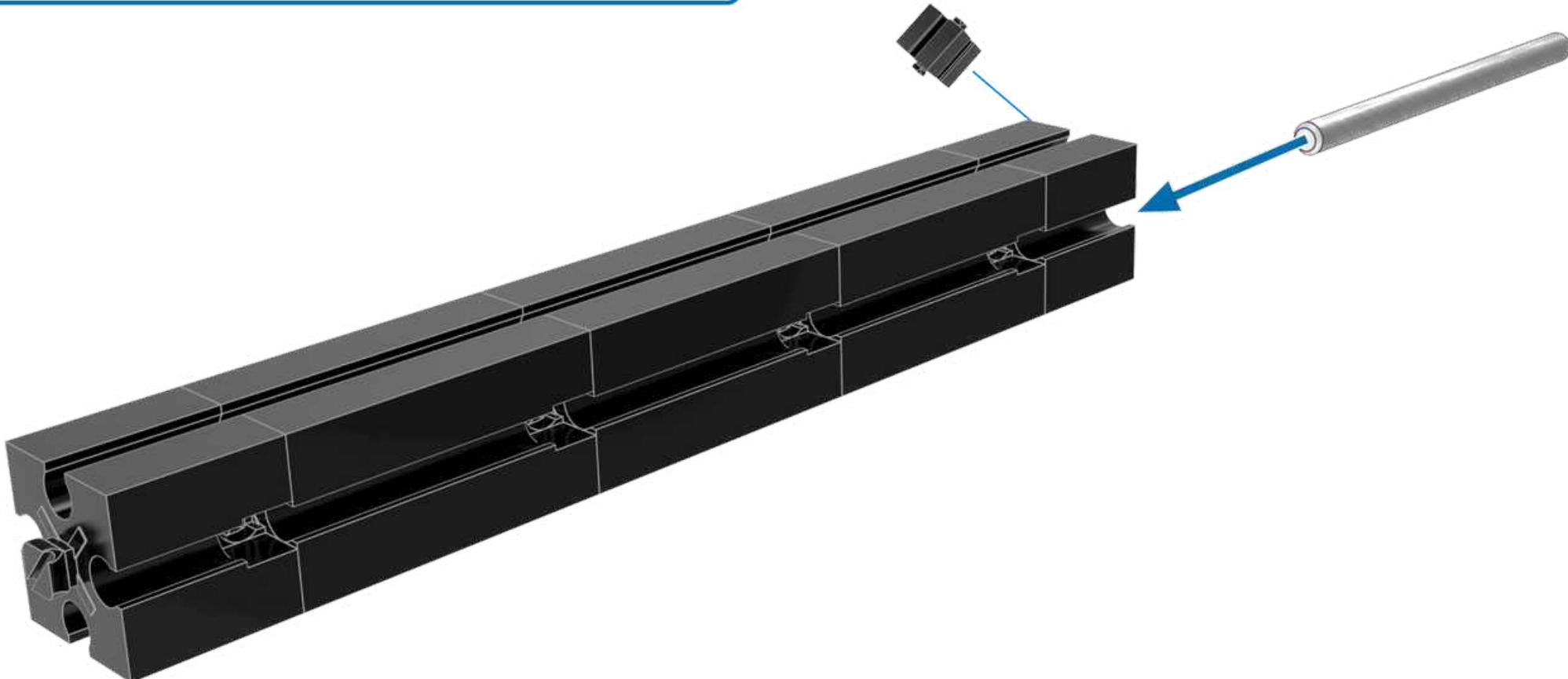



18  3x  1x  1x  60 1x



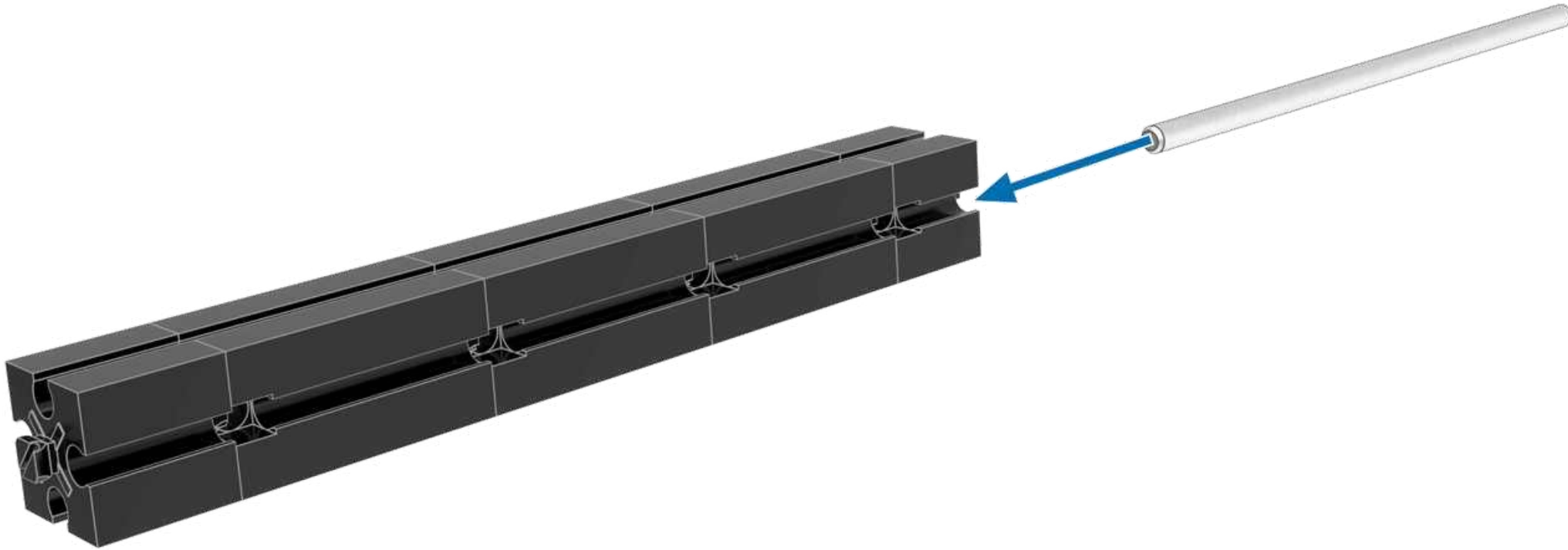

19  3x  1x  1x  1x



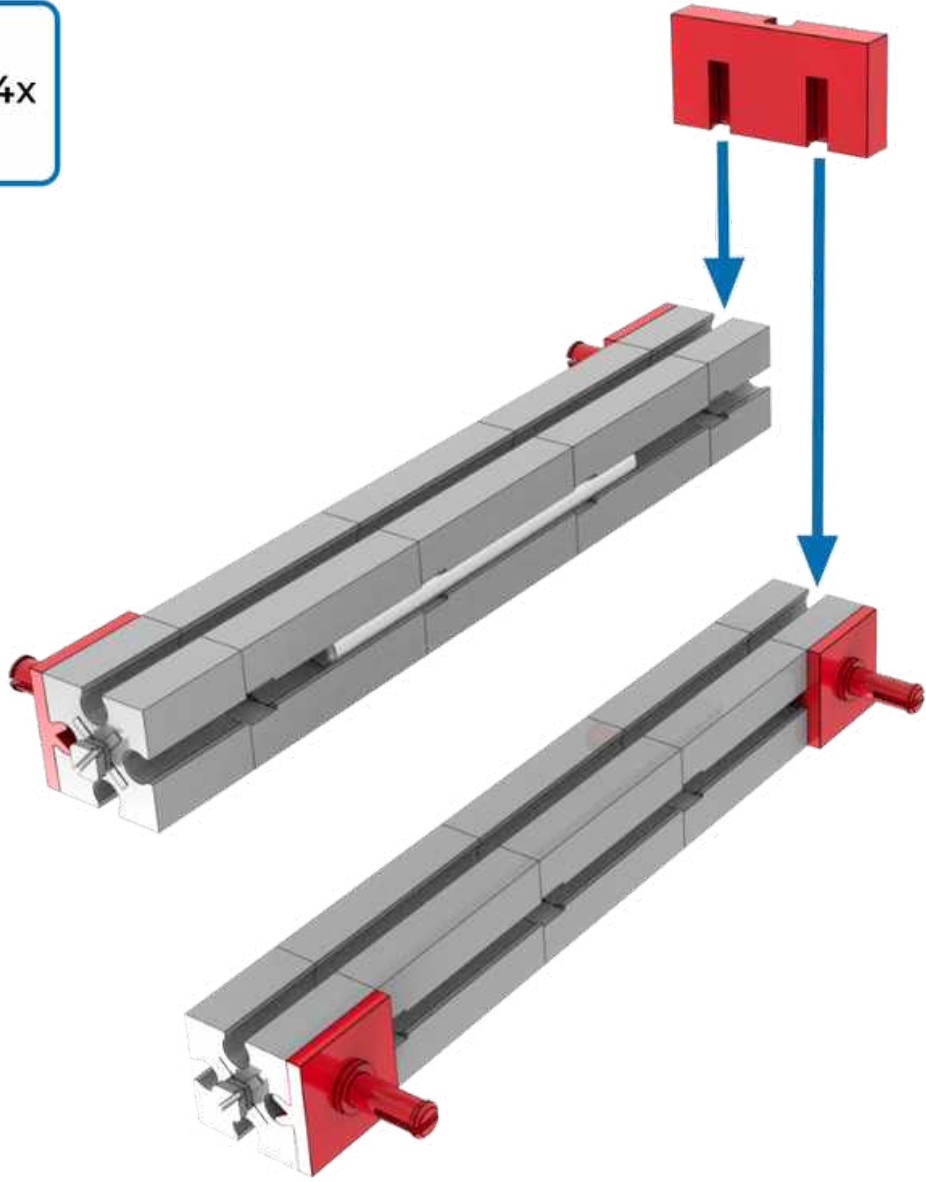

20  1x  4x

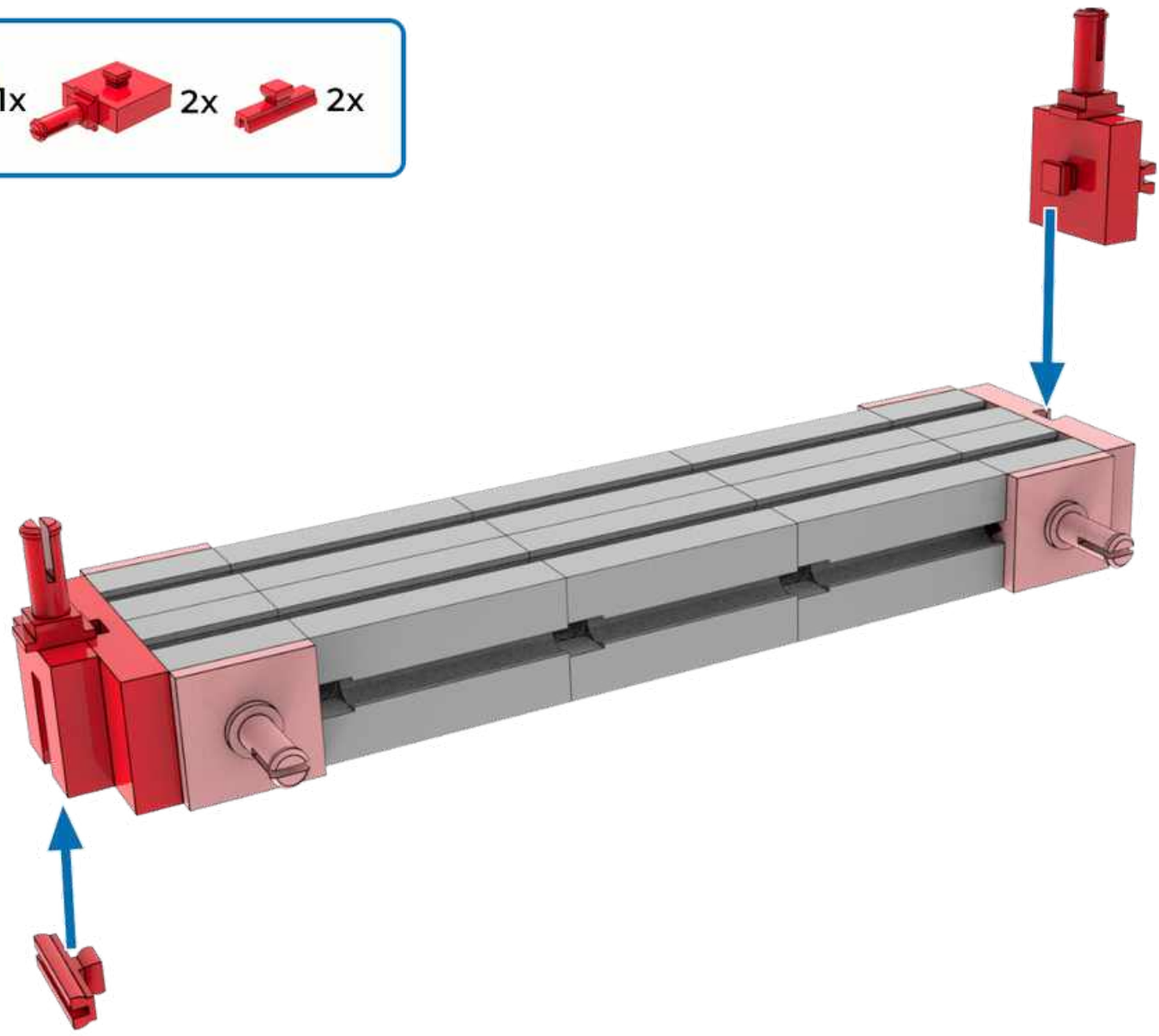

21  1x  2x  2x





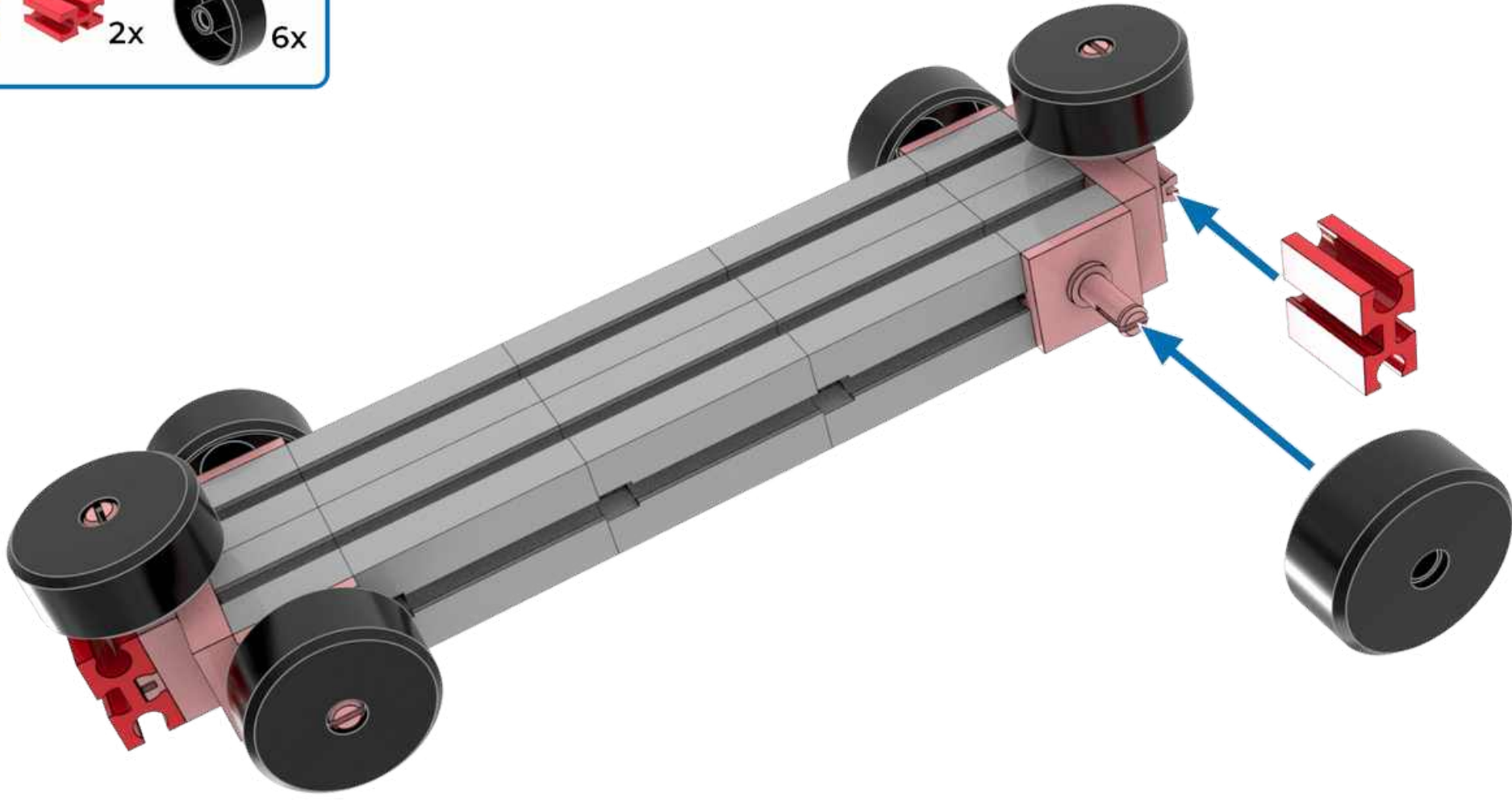

22  2x  6x

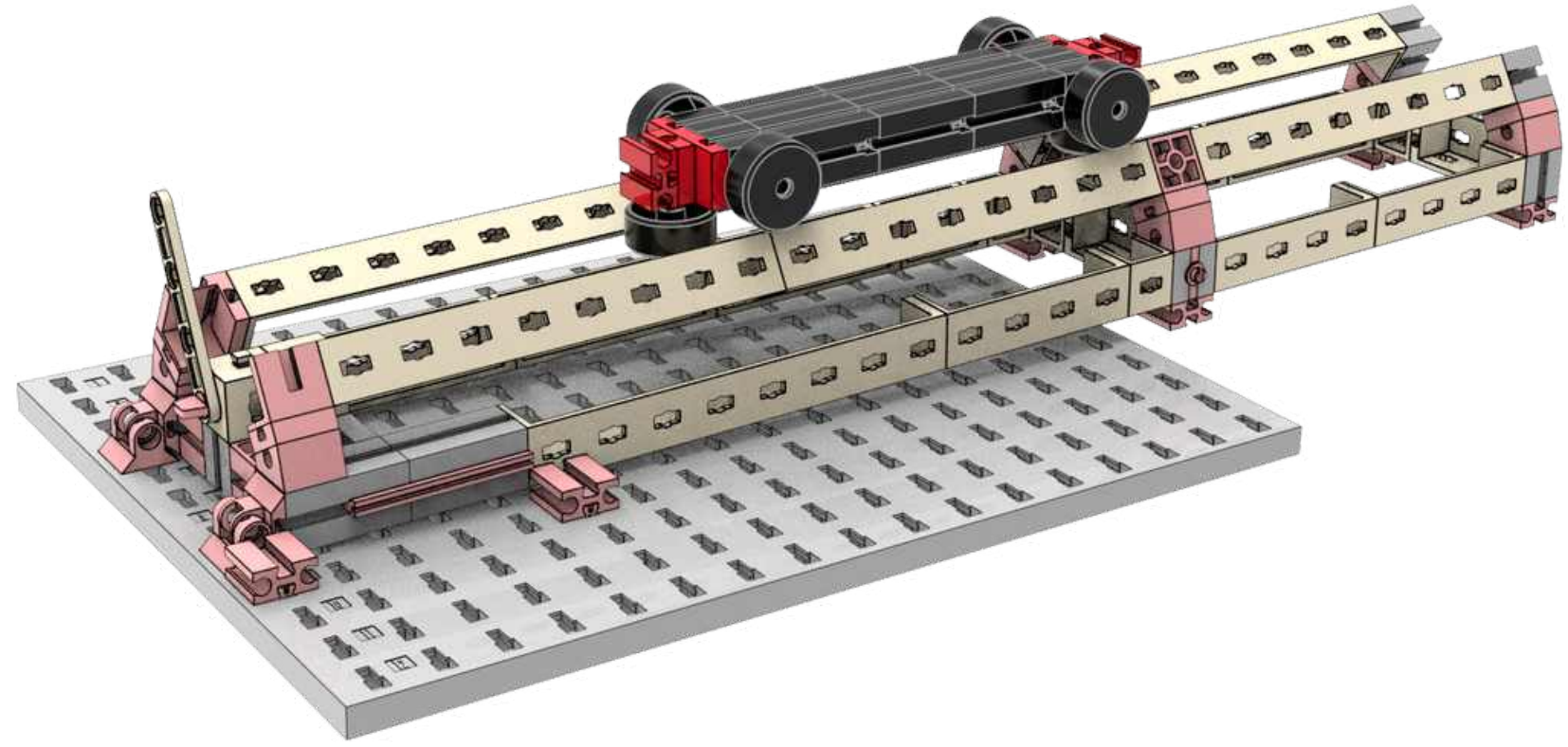



23

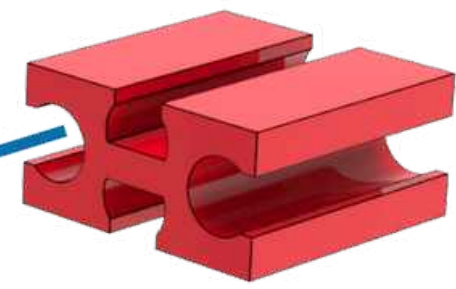
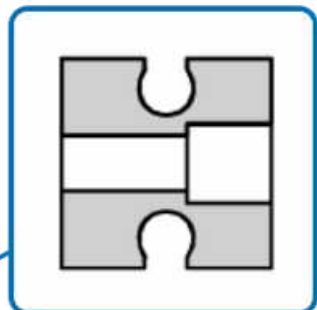
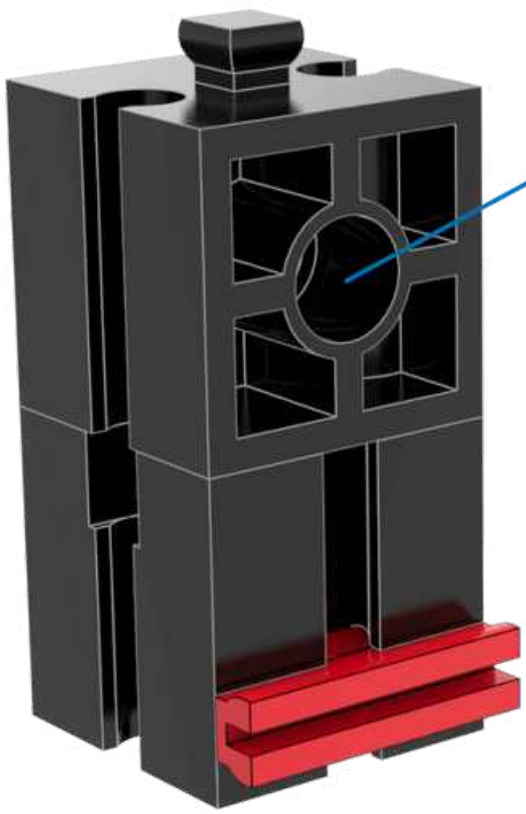

24  1x  1x  1x  1x



25  1x  1x  1x

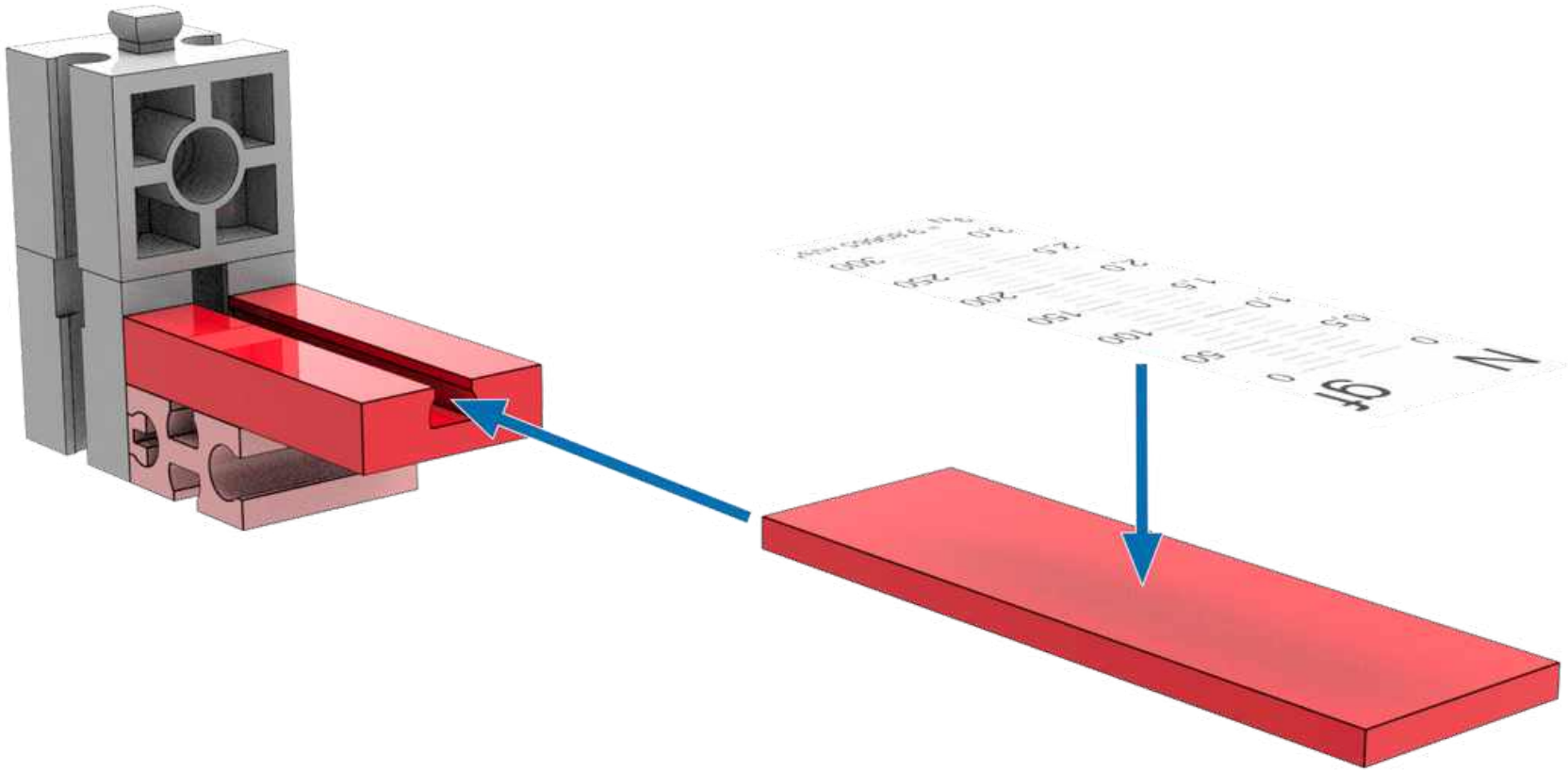

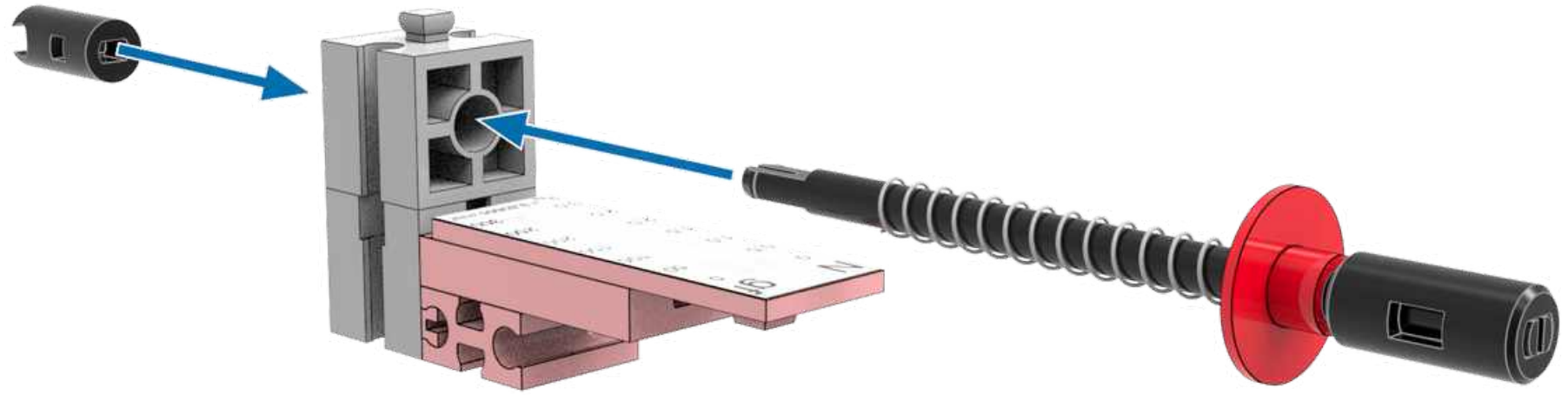
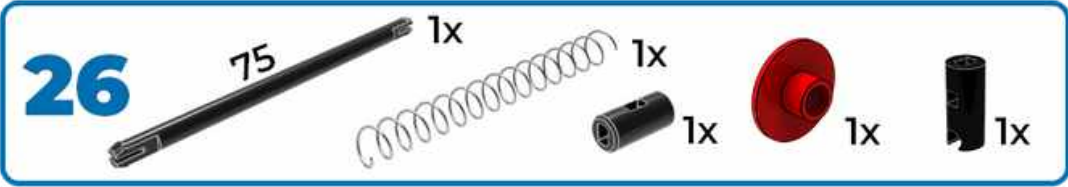

26 75 1x
1x 1x 1x 1x 1x

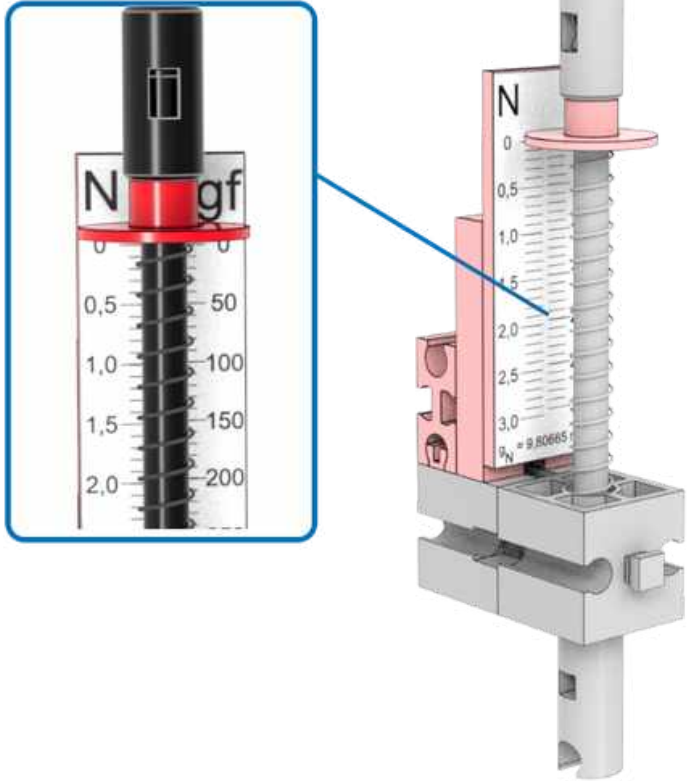



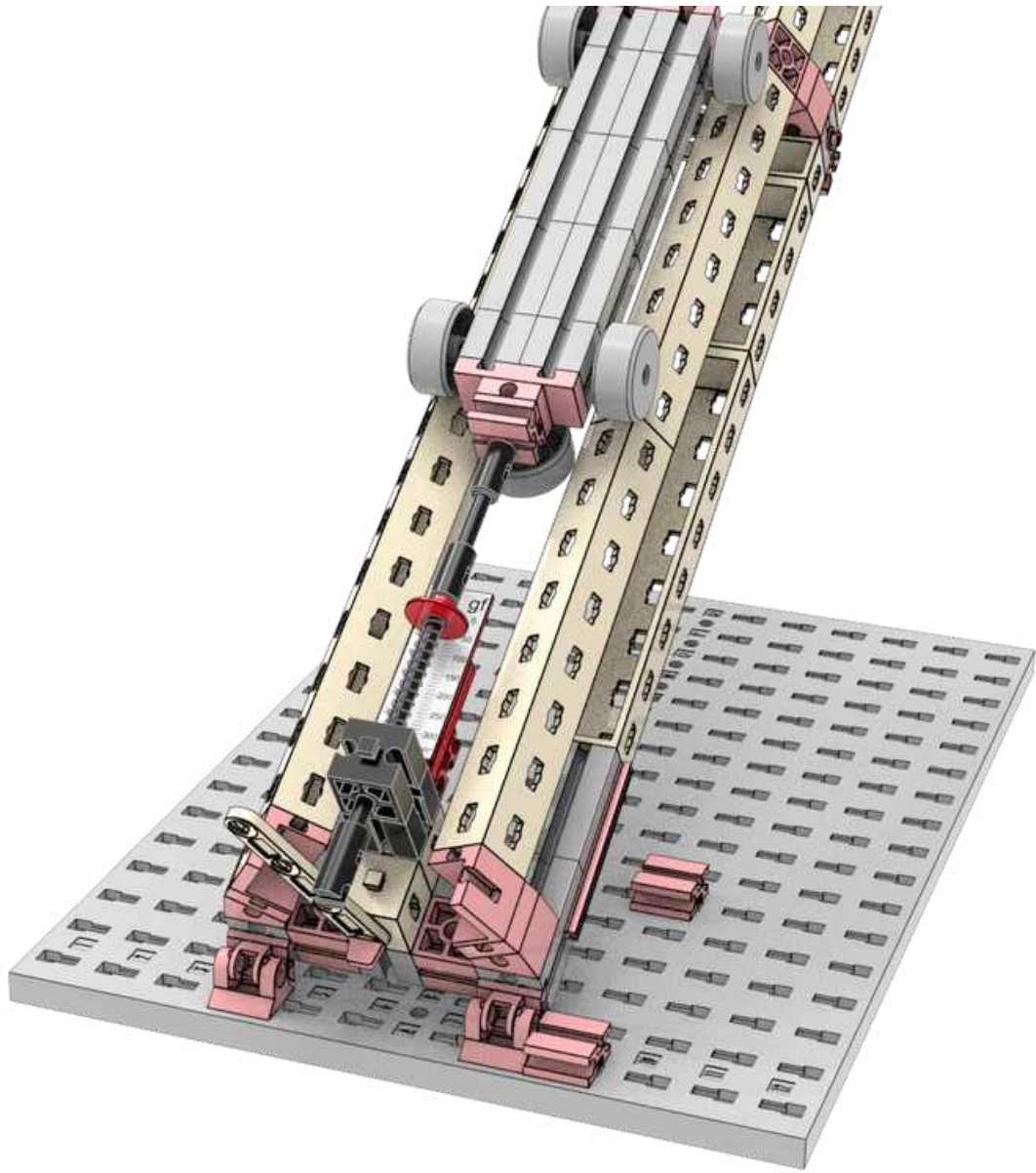

28

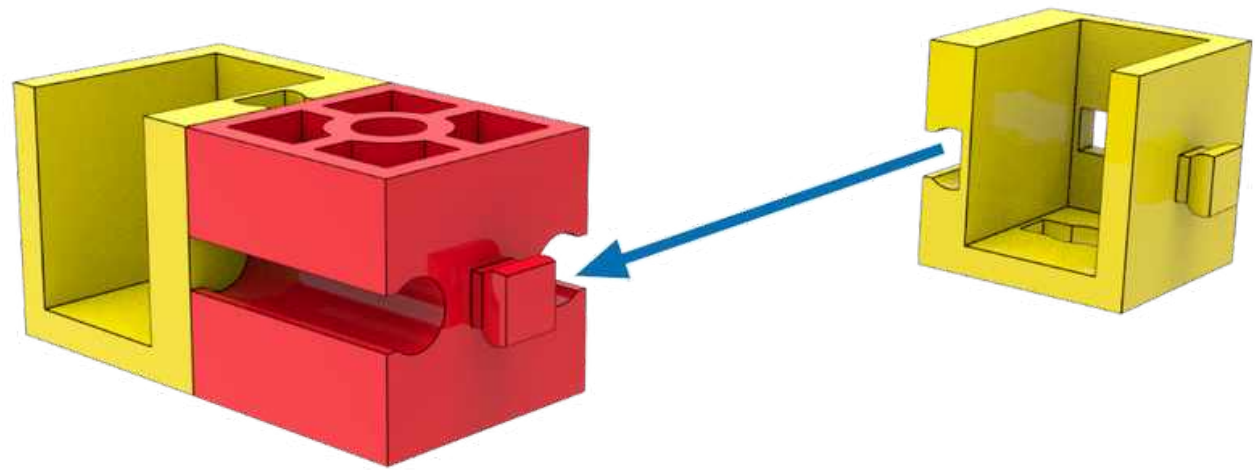

29  1x  2x



30  2x  2x

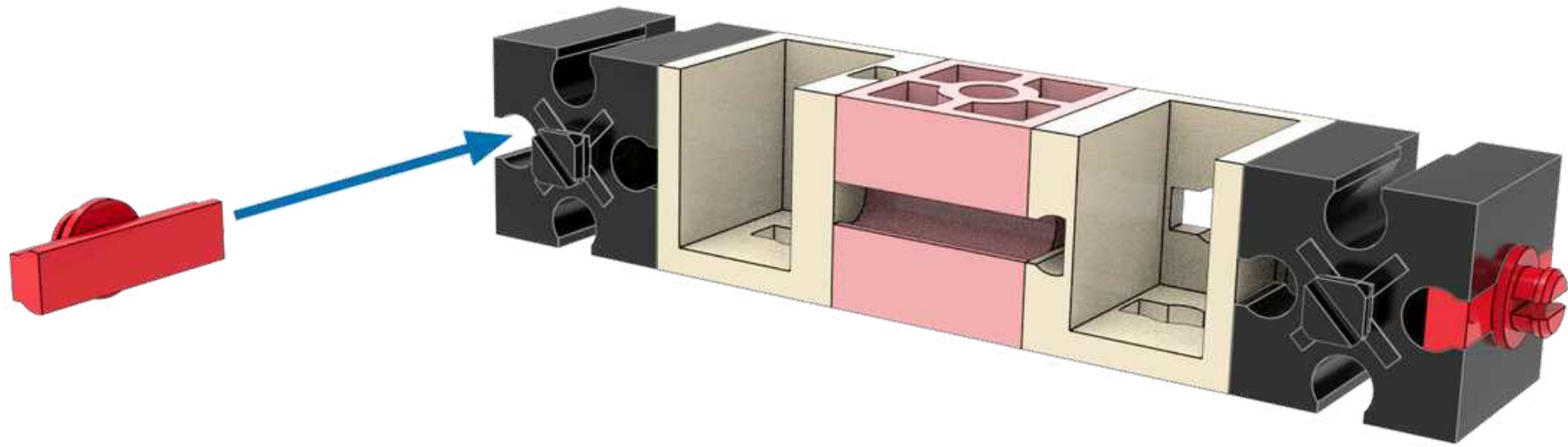

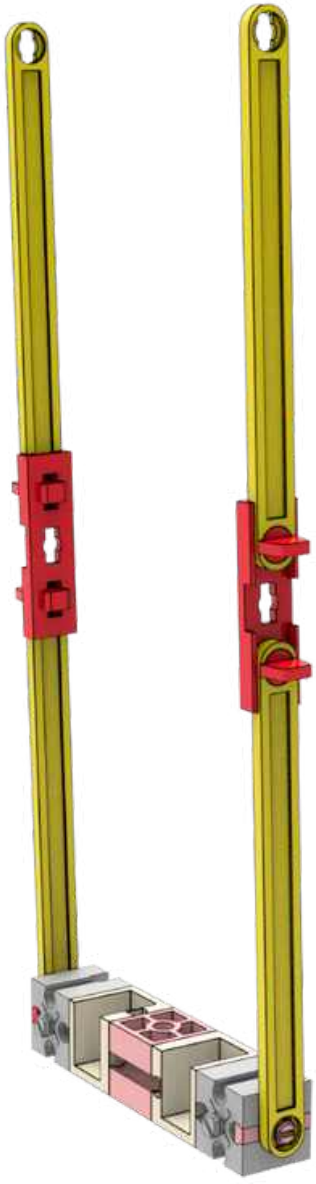
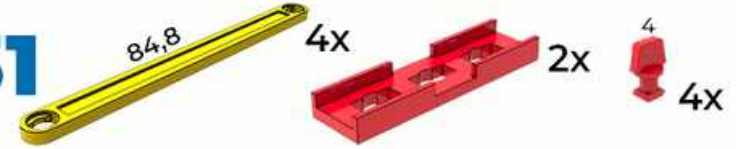

31 84,8 4x 2x 4 4x





32



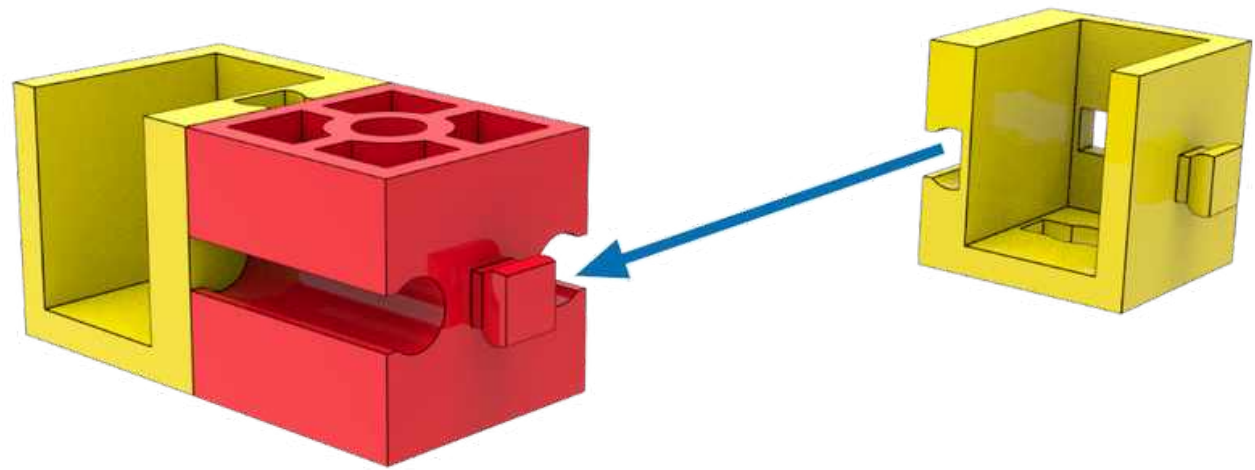

33  1x  2x

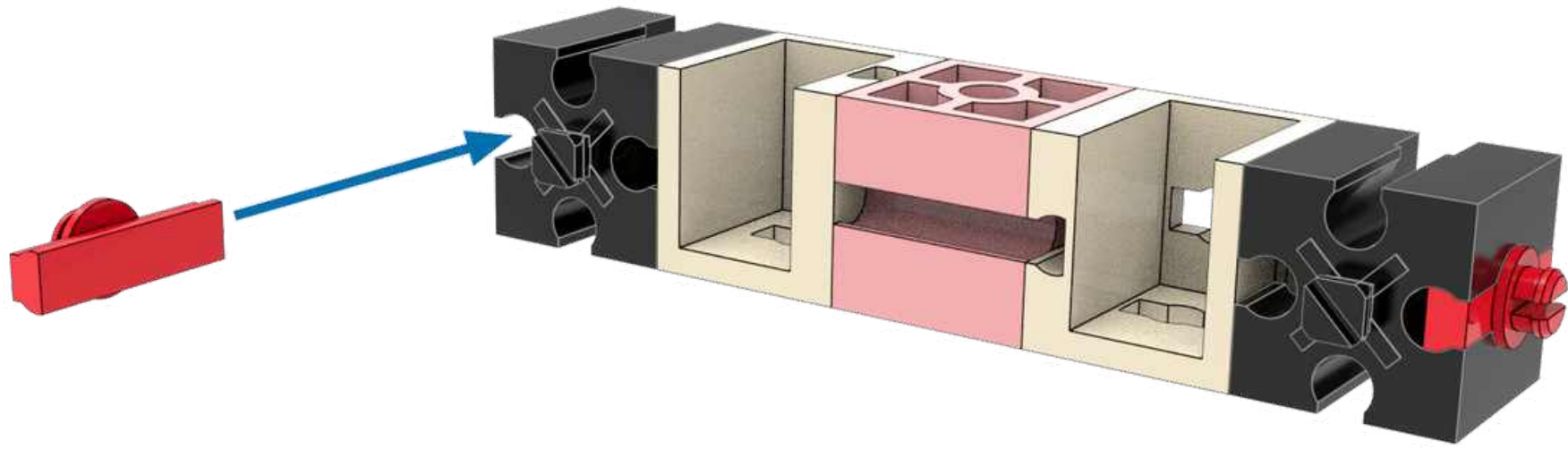

34  2x  2x

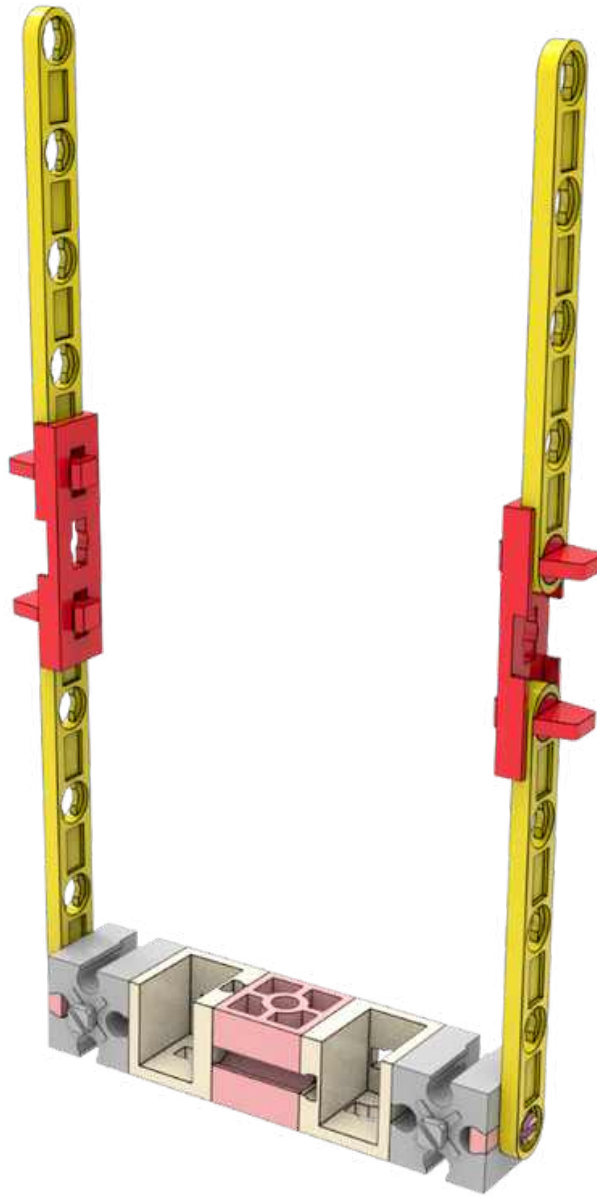

35 60 4x 2x 4 4x



36



Zählwerk

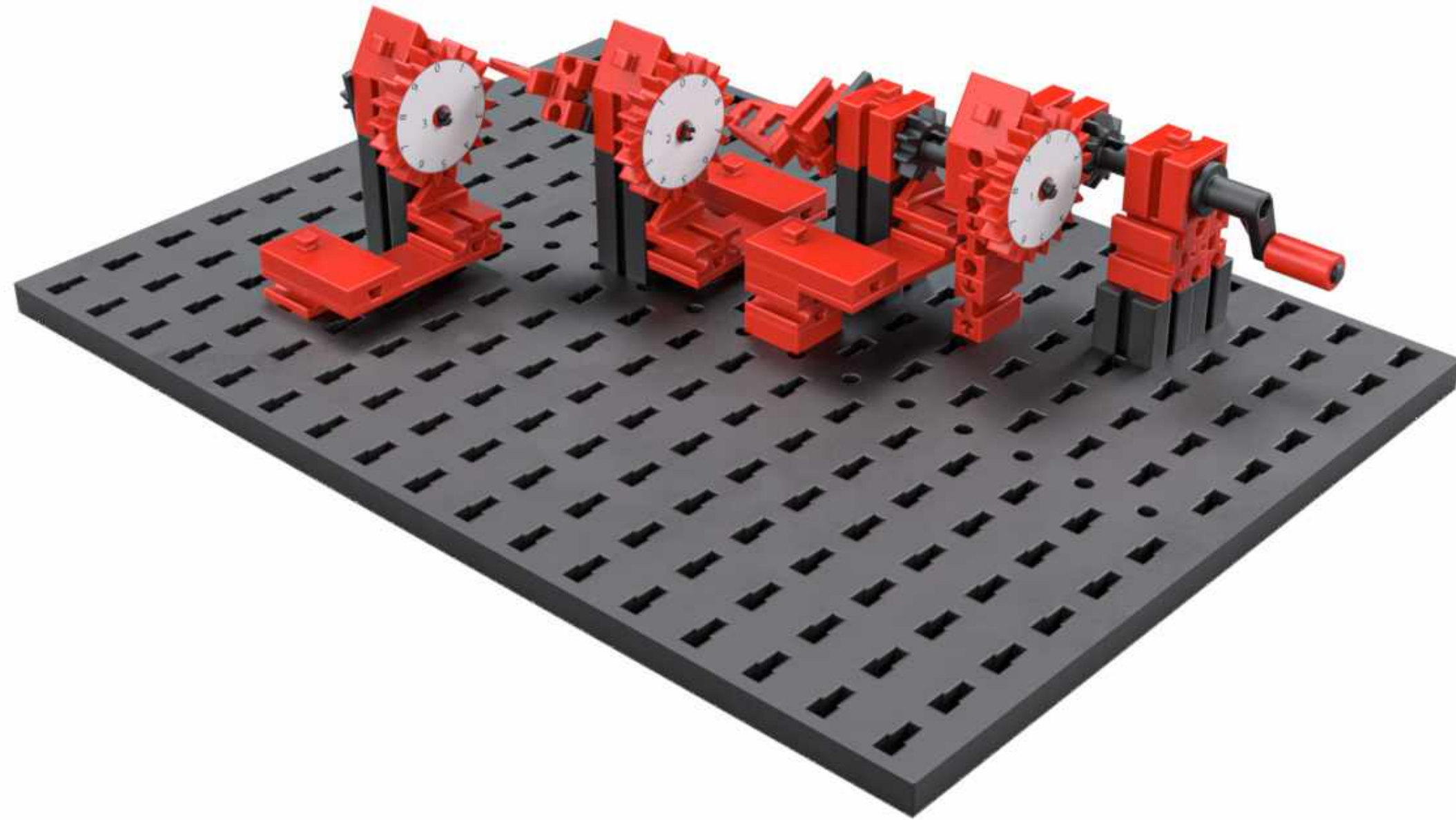

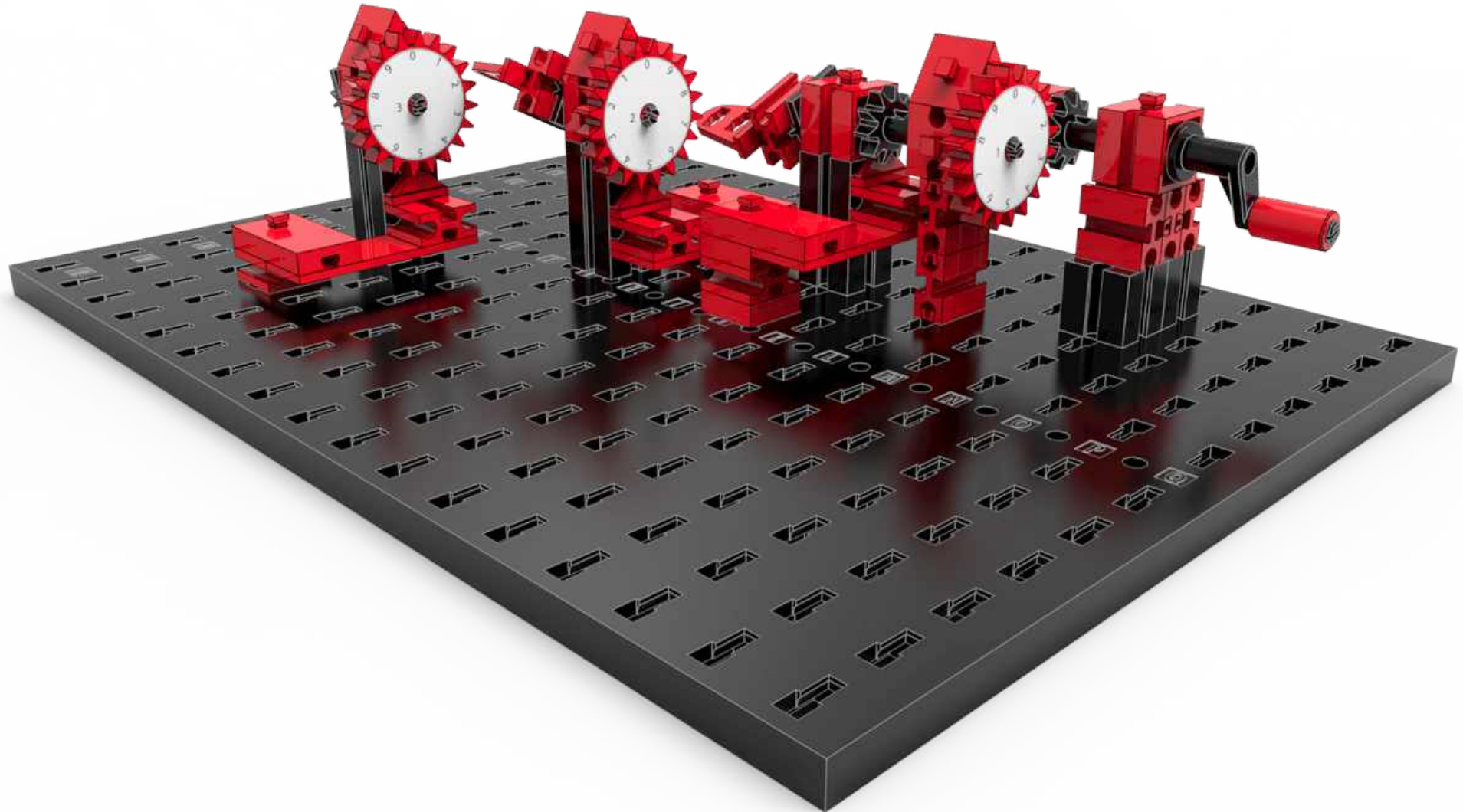

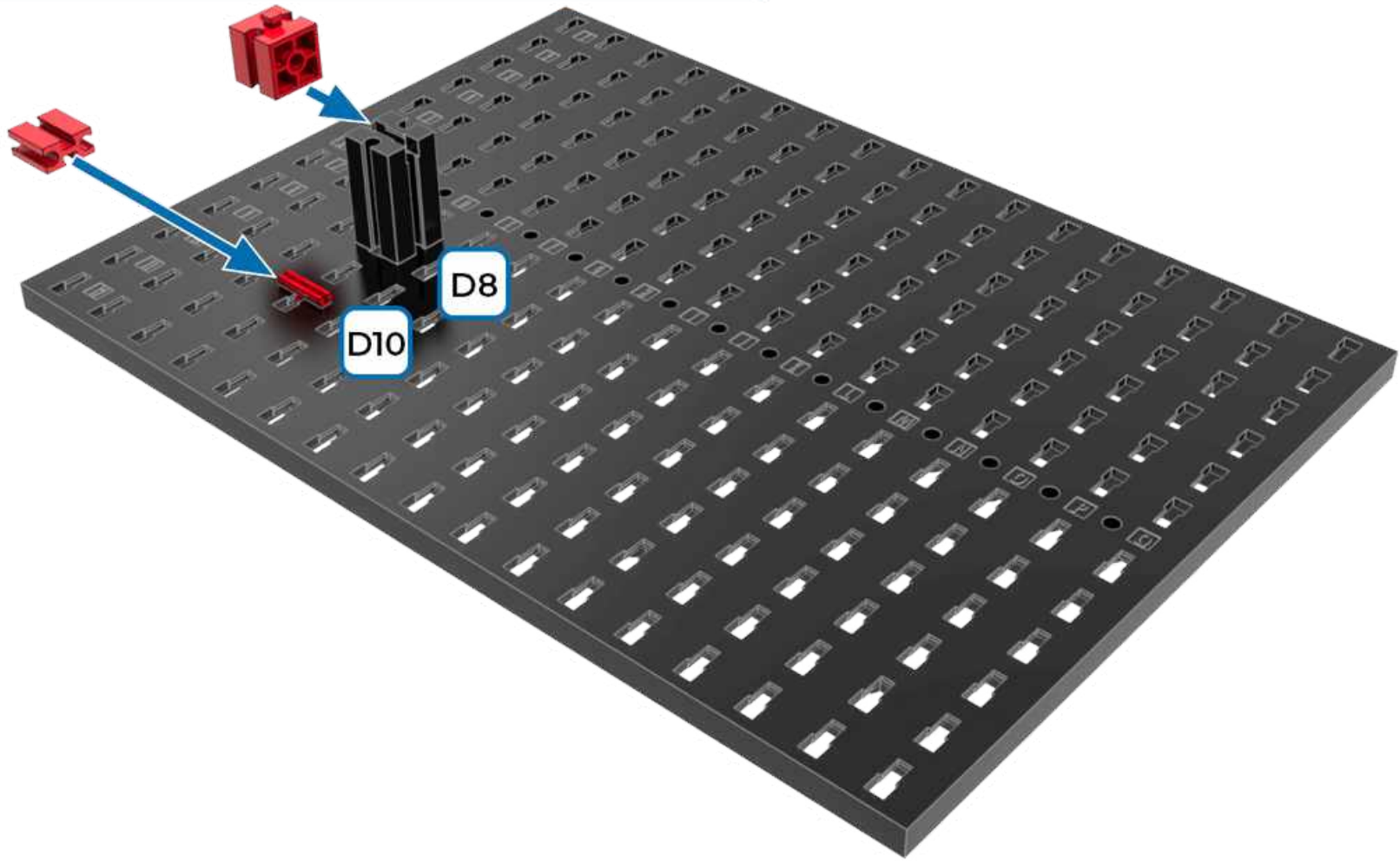
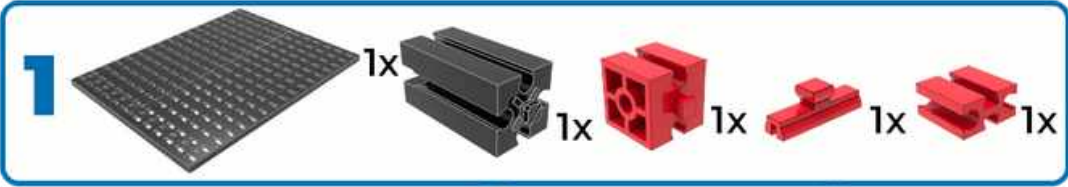

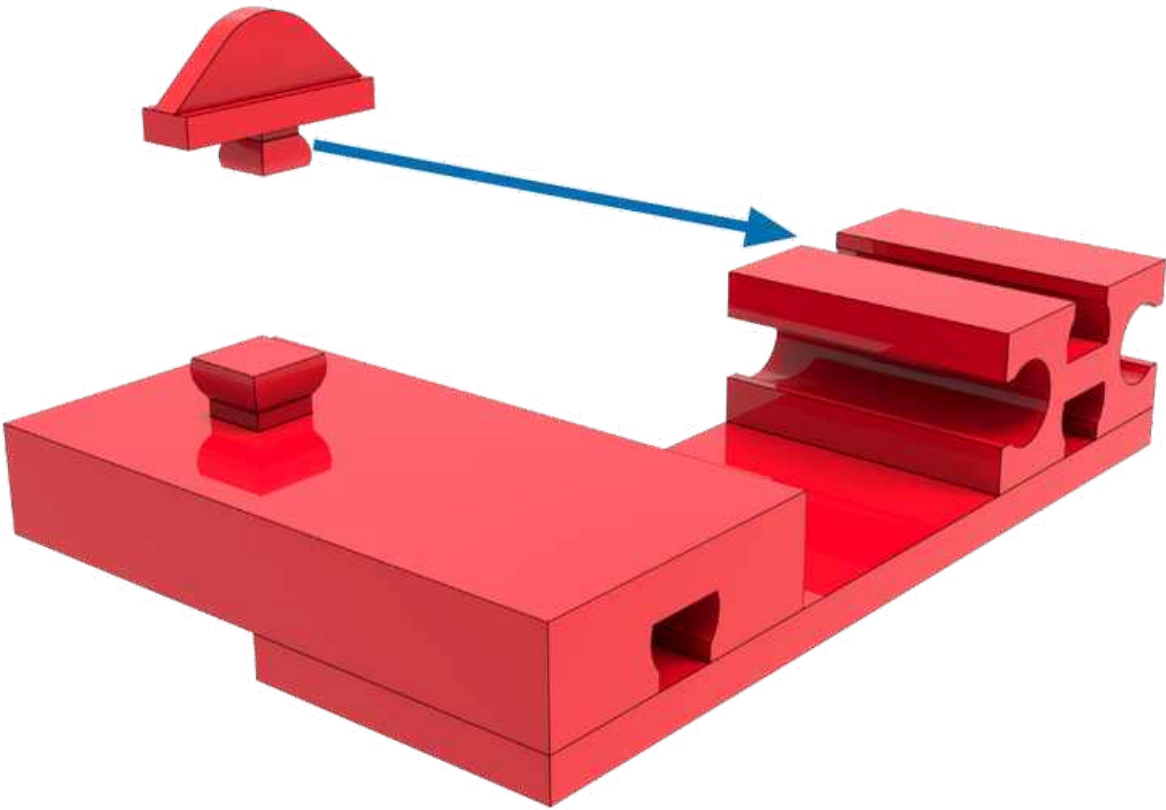
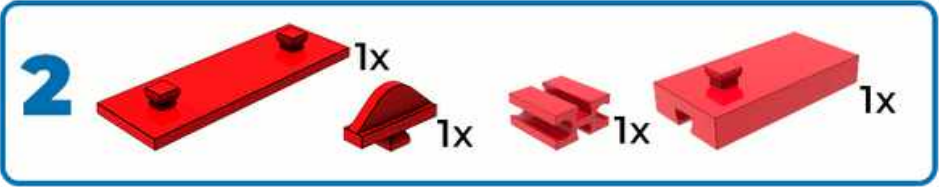



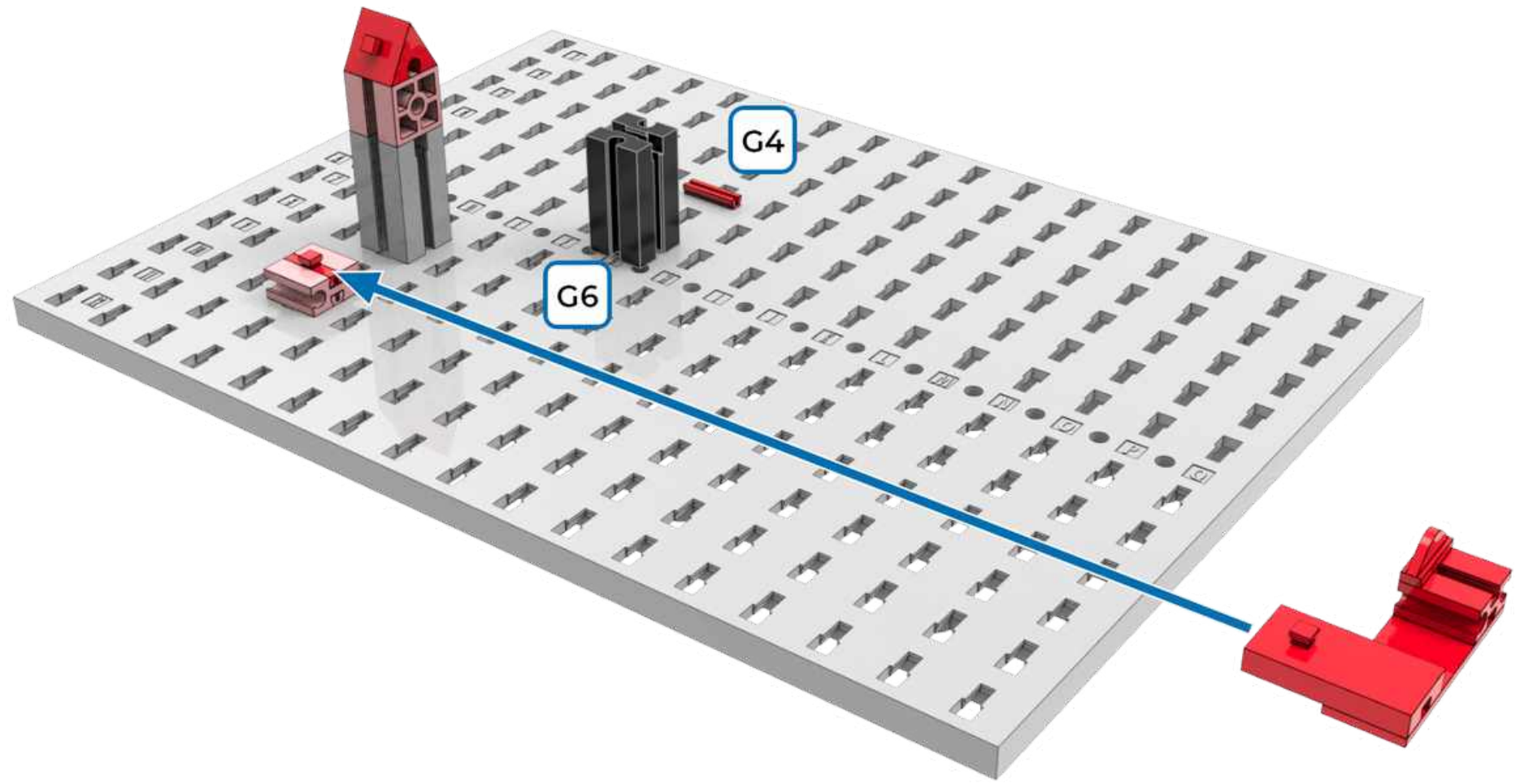

3 1x 1x 1x 2x

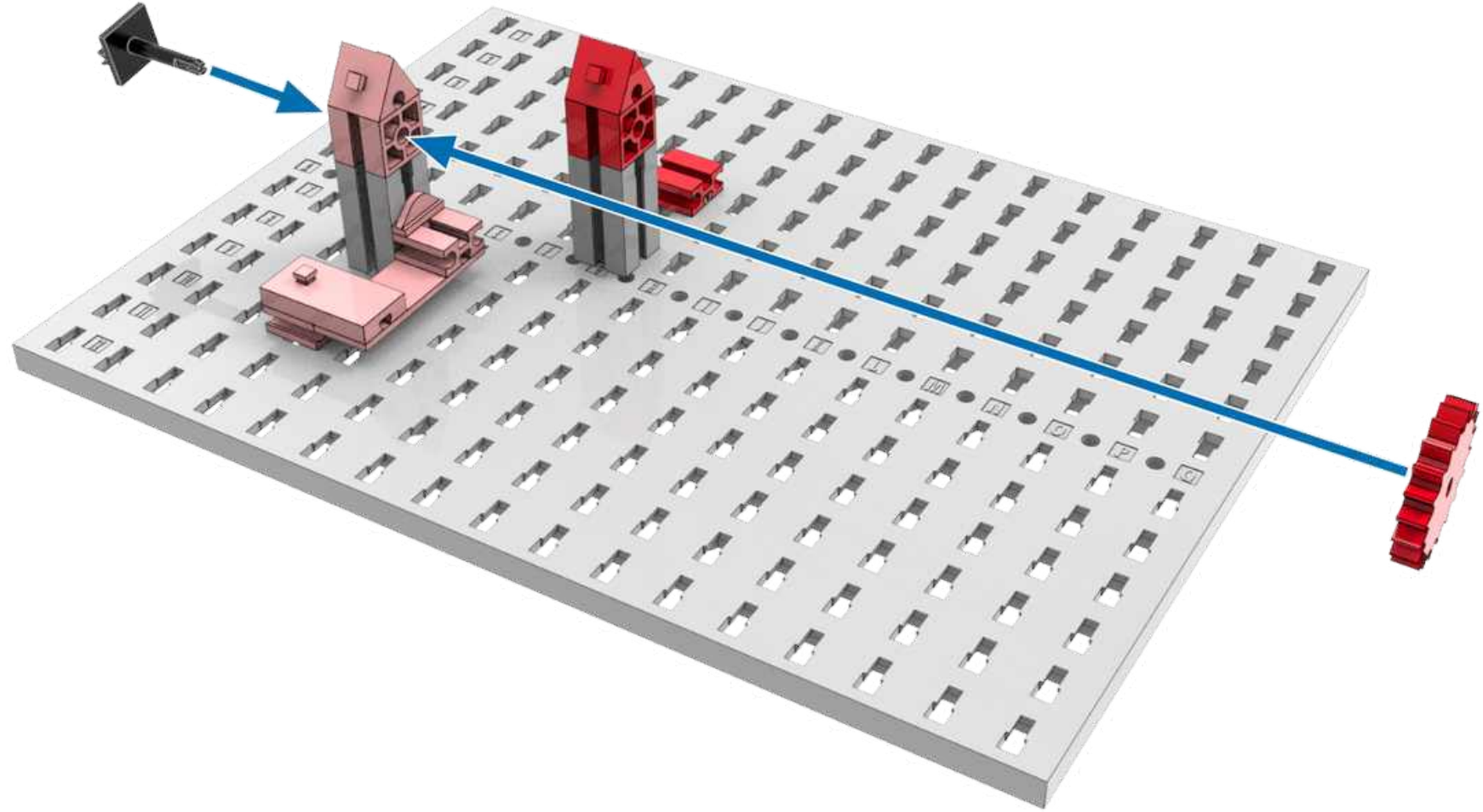
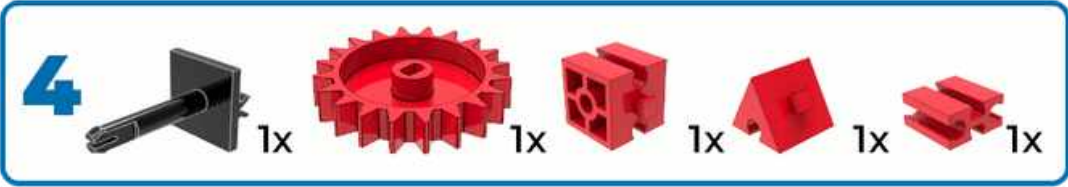

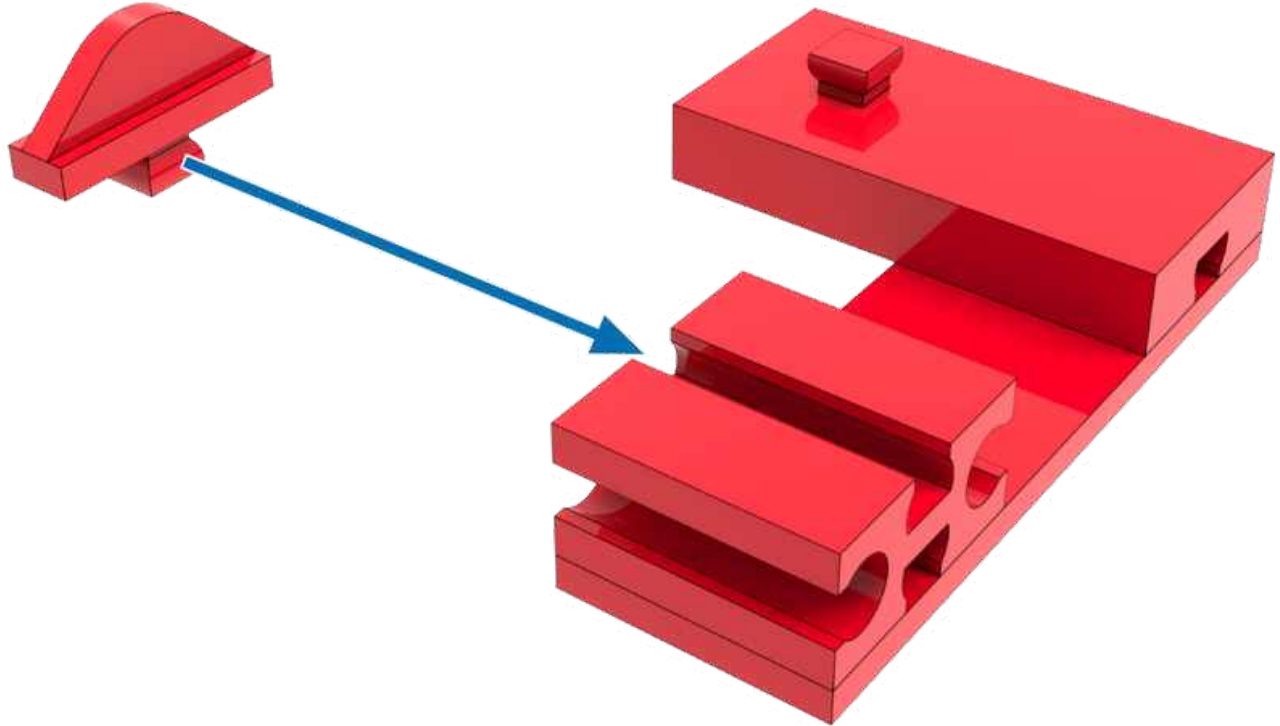
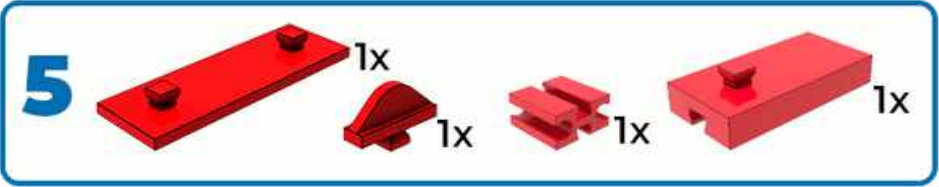





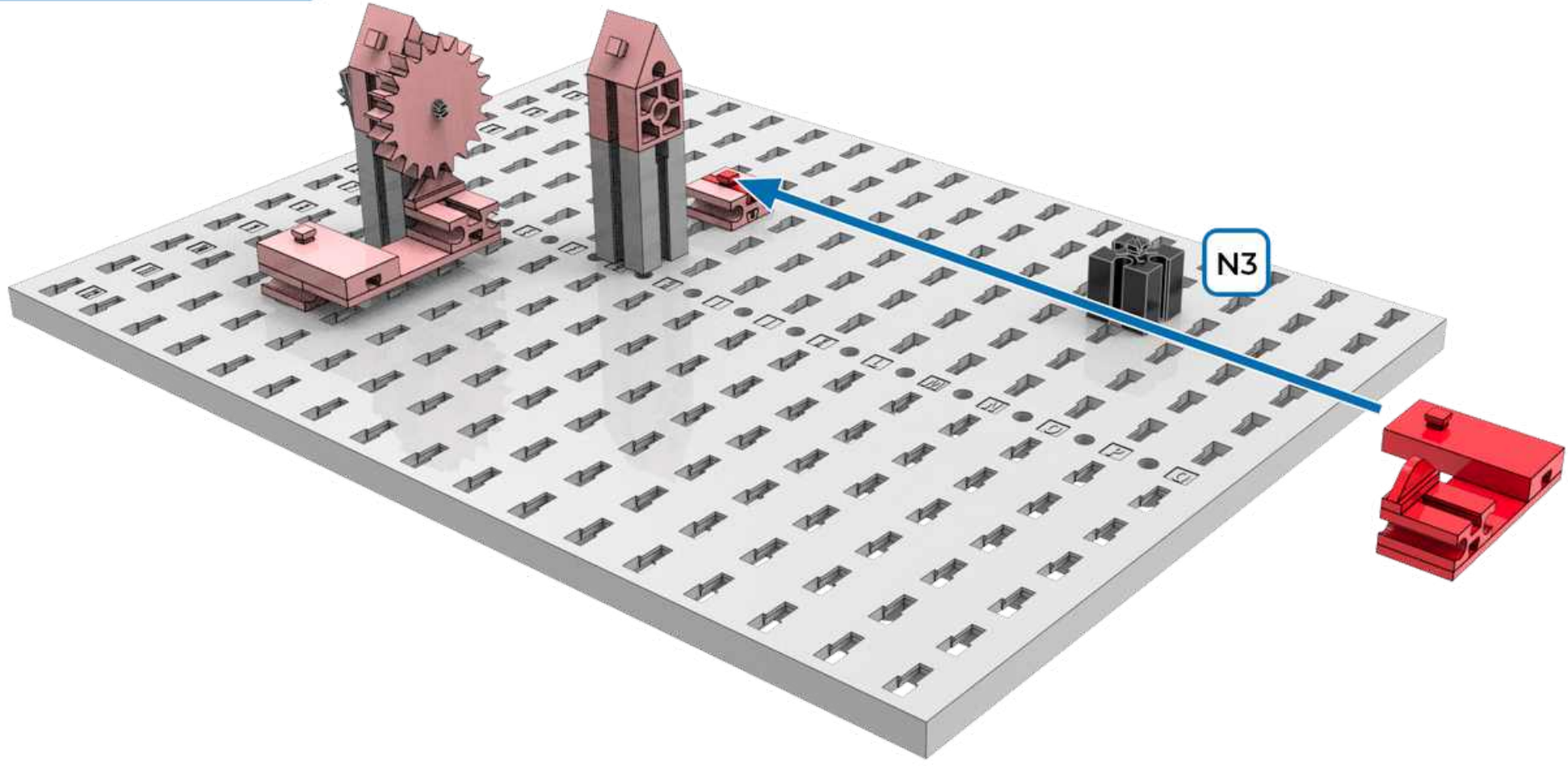

6  1x  1x

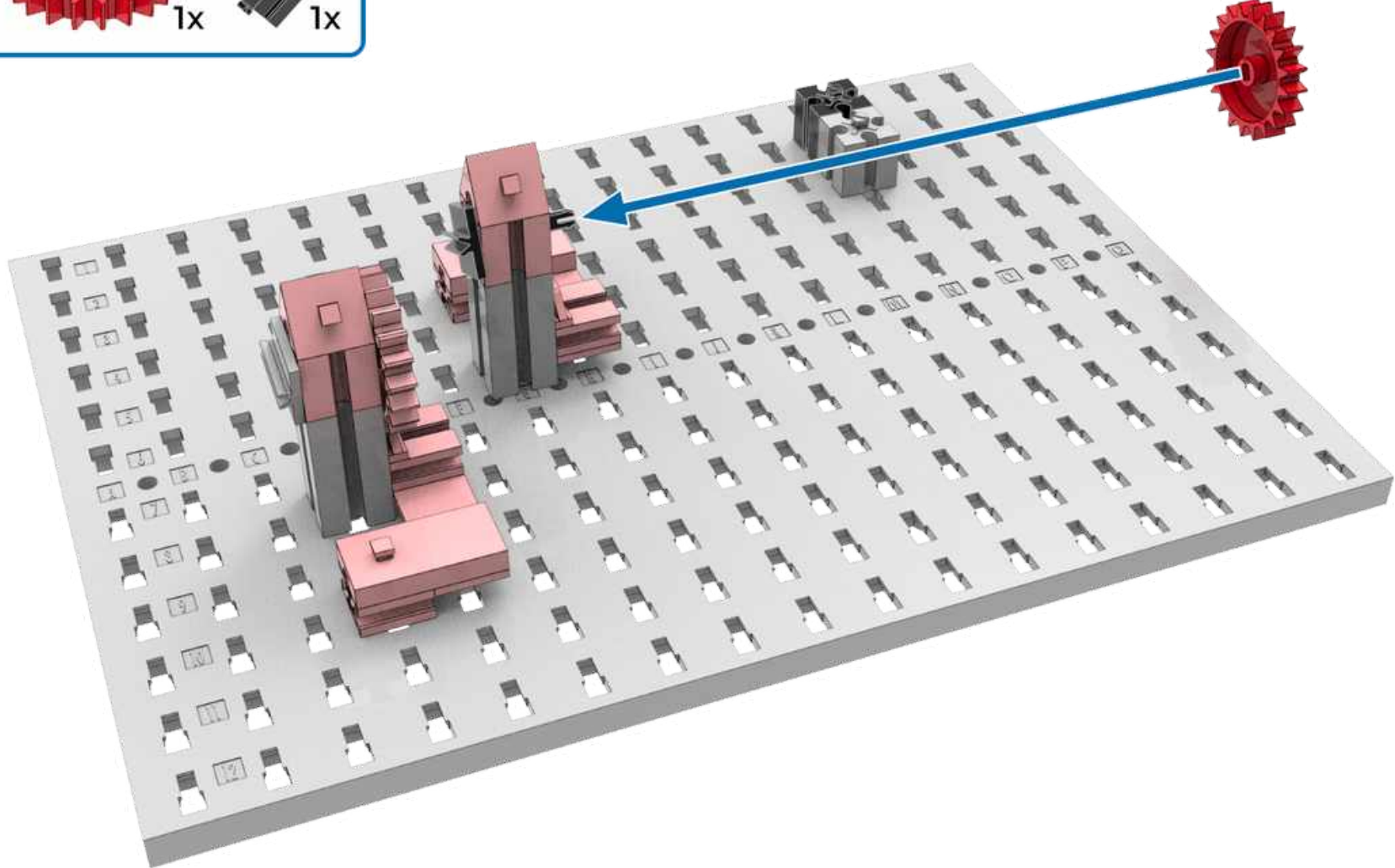

7  1x  1x  1x



8  1x  1x

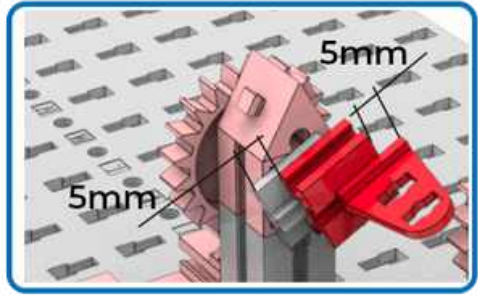
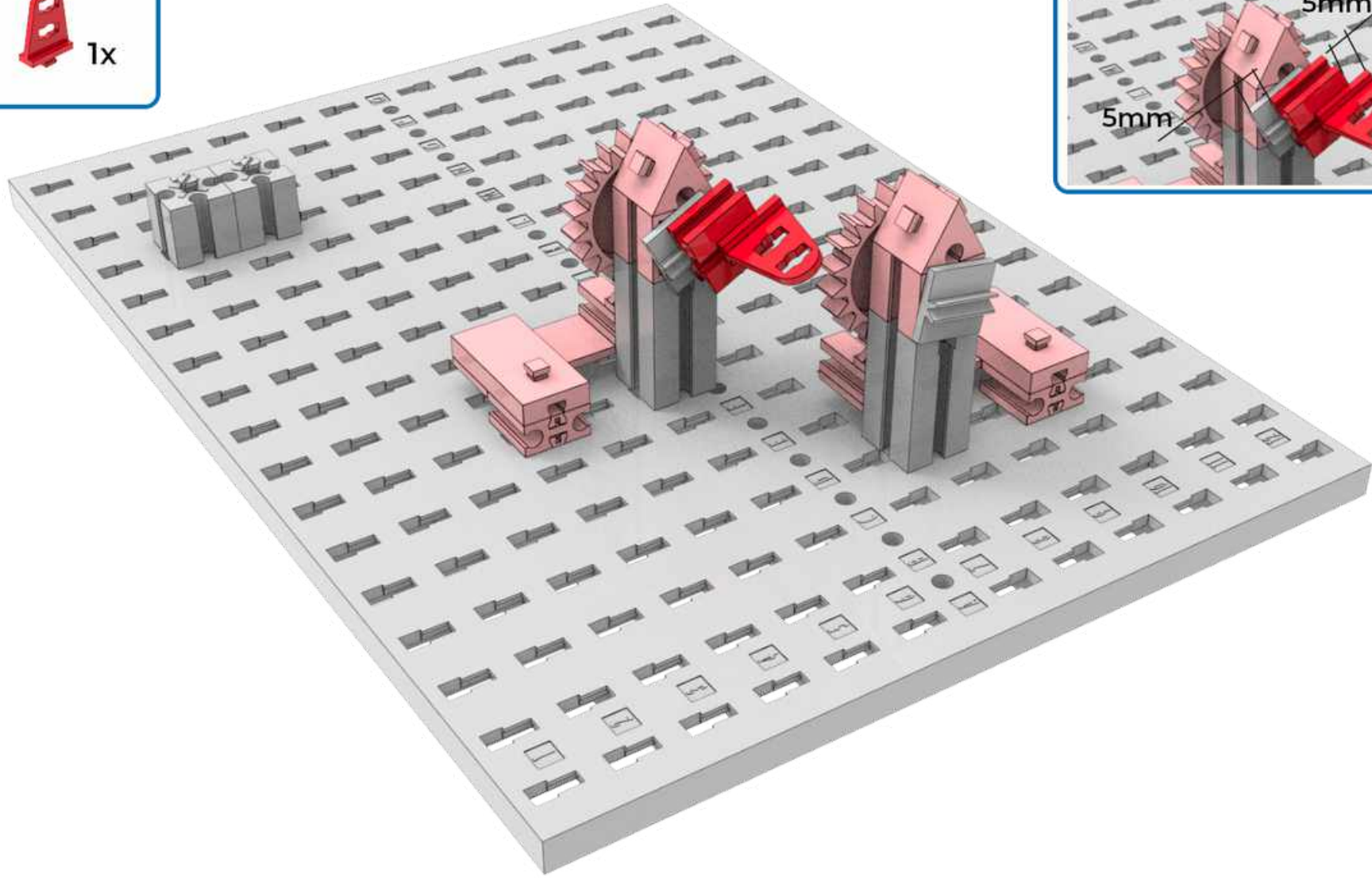

9



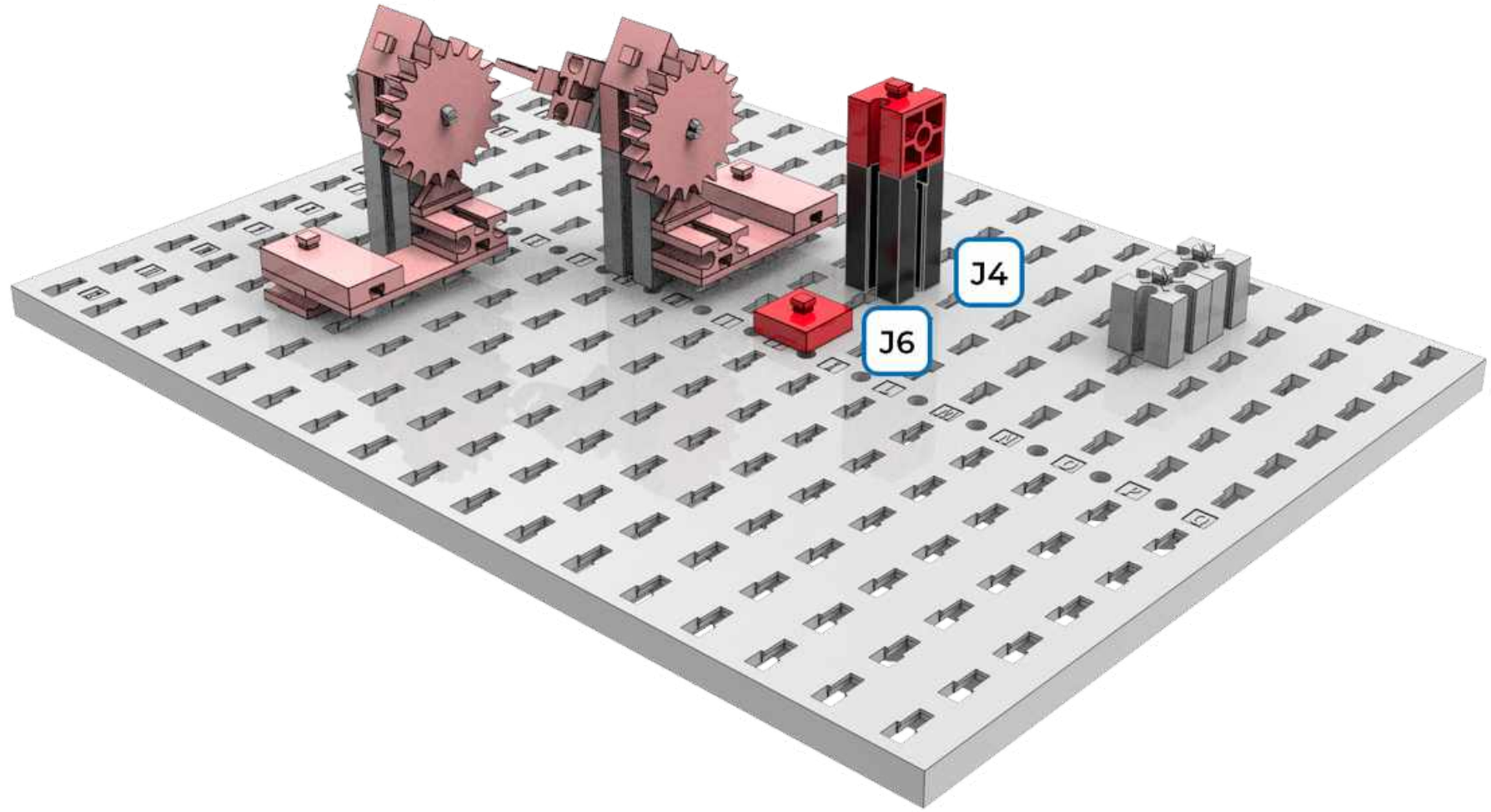

1x 1x 1x

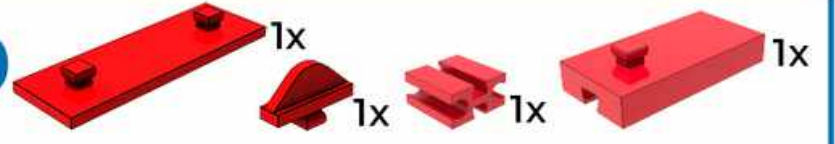

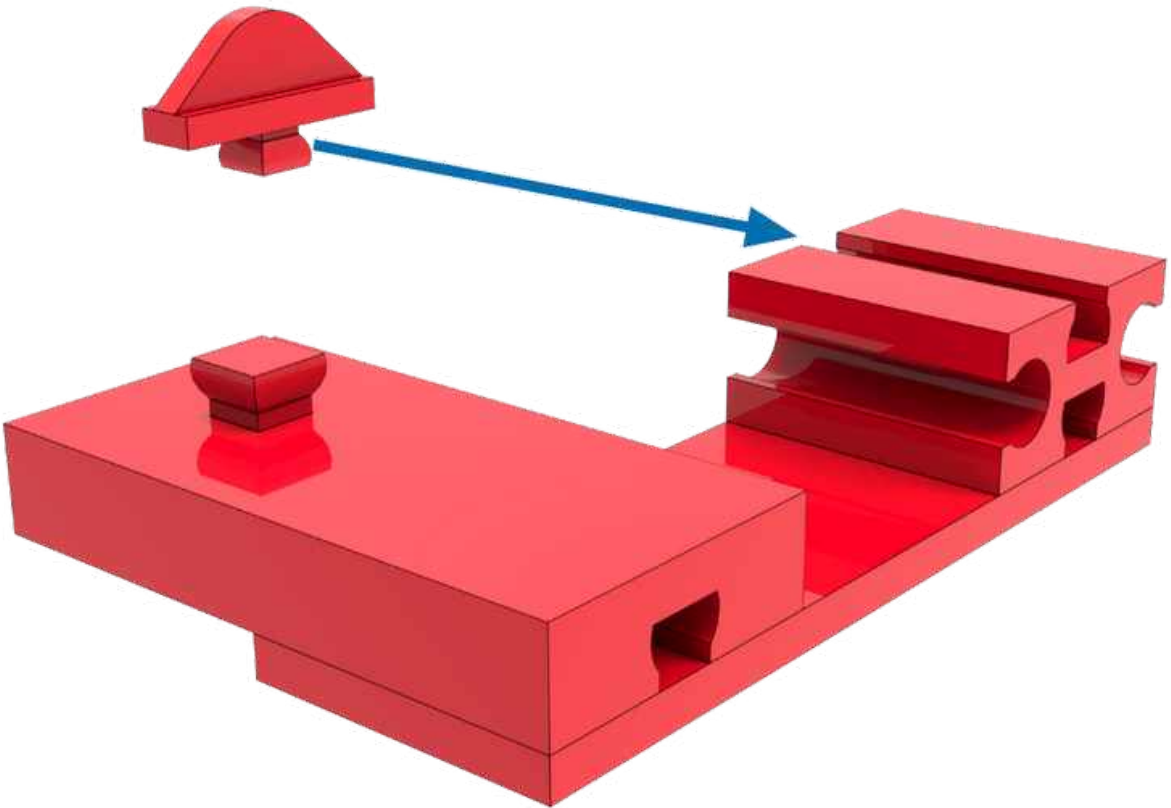

10  1x 1x 1x 1x

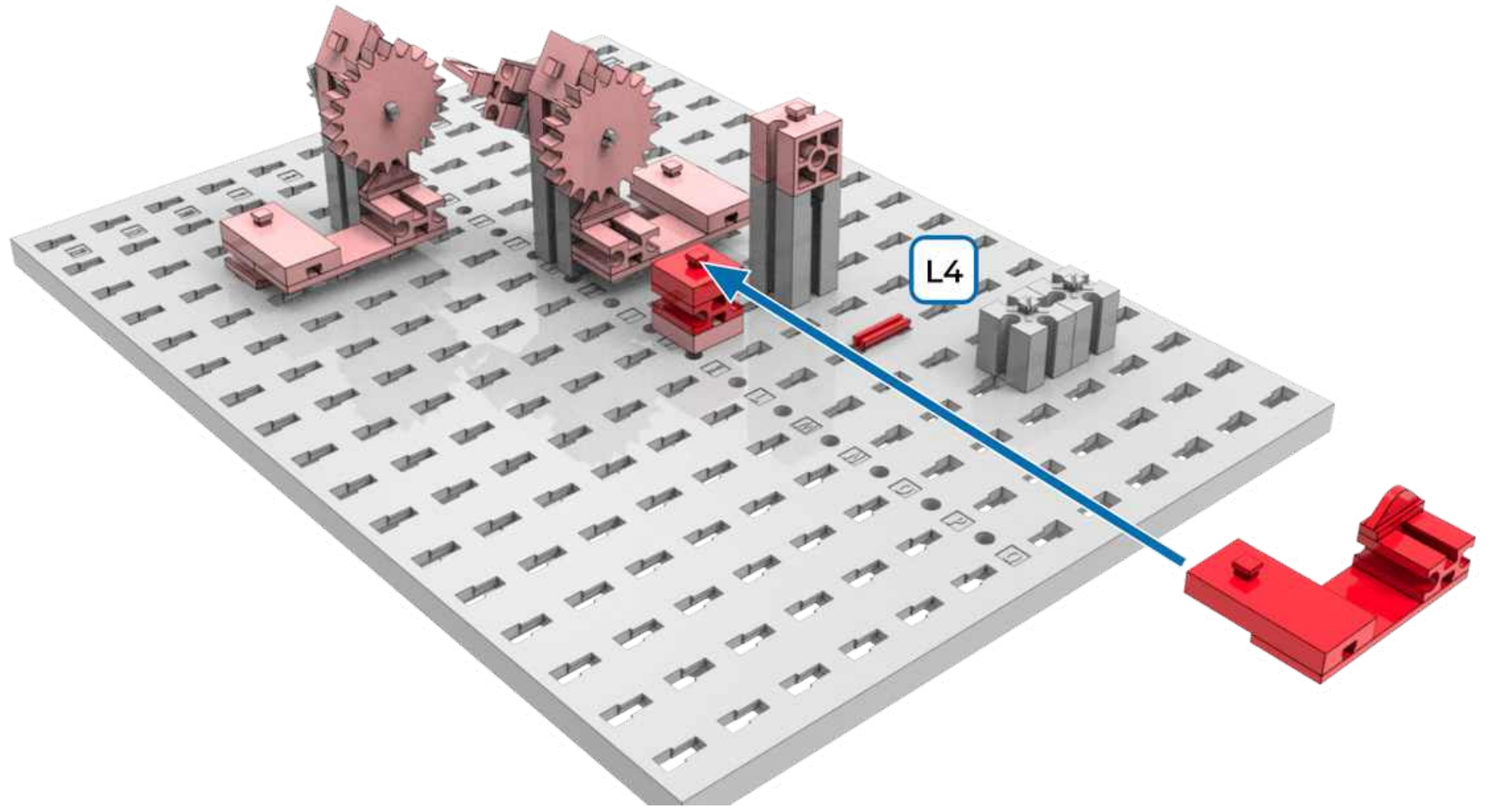

11  1x  1x  1x



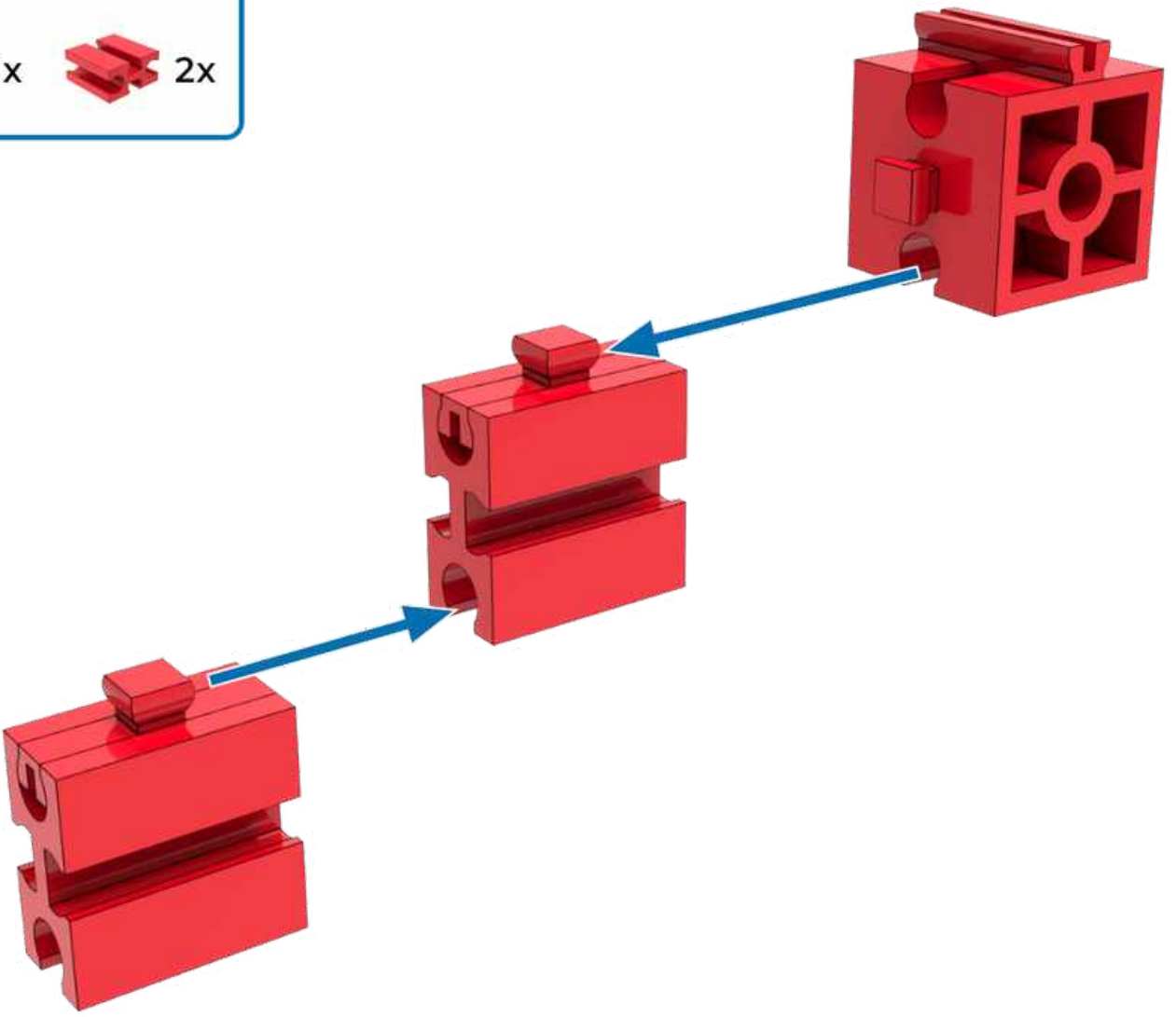

12  3x  1x  2x



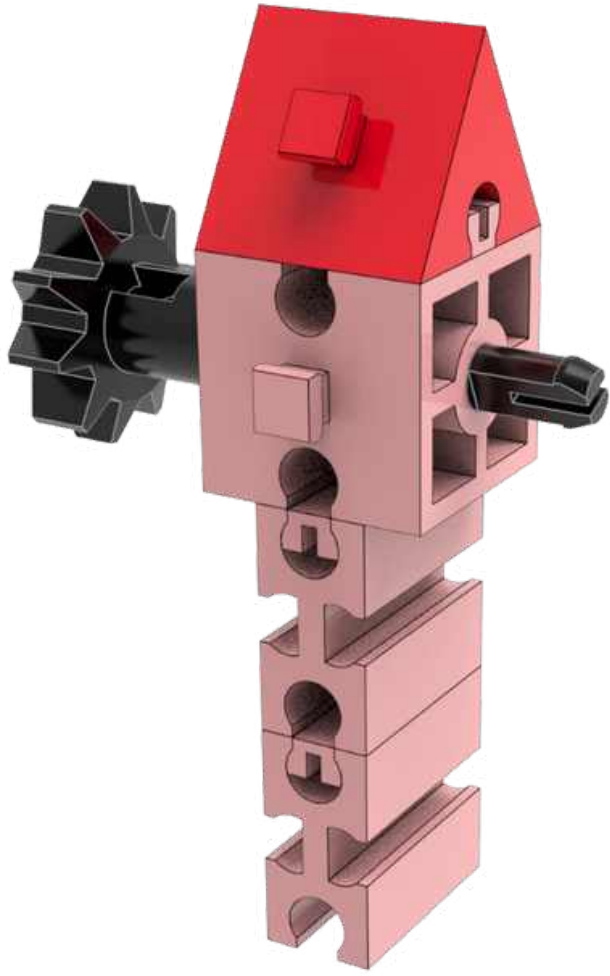

13  1x  30 1x  1x



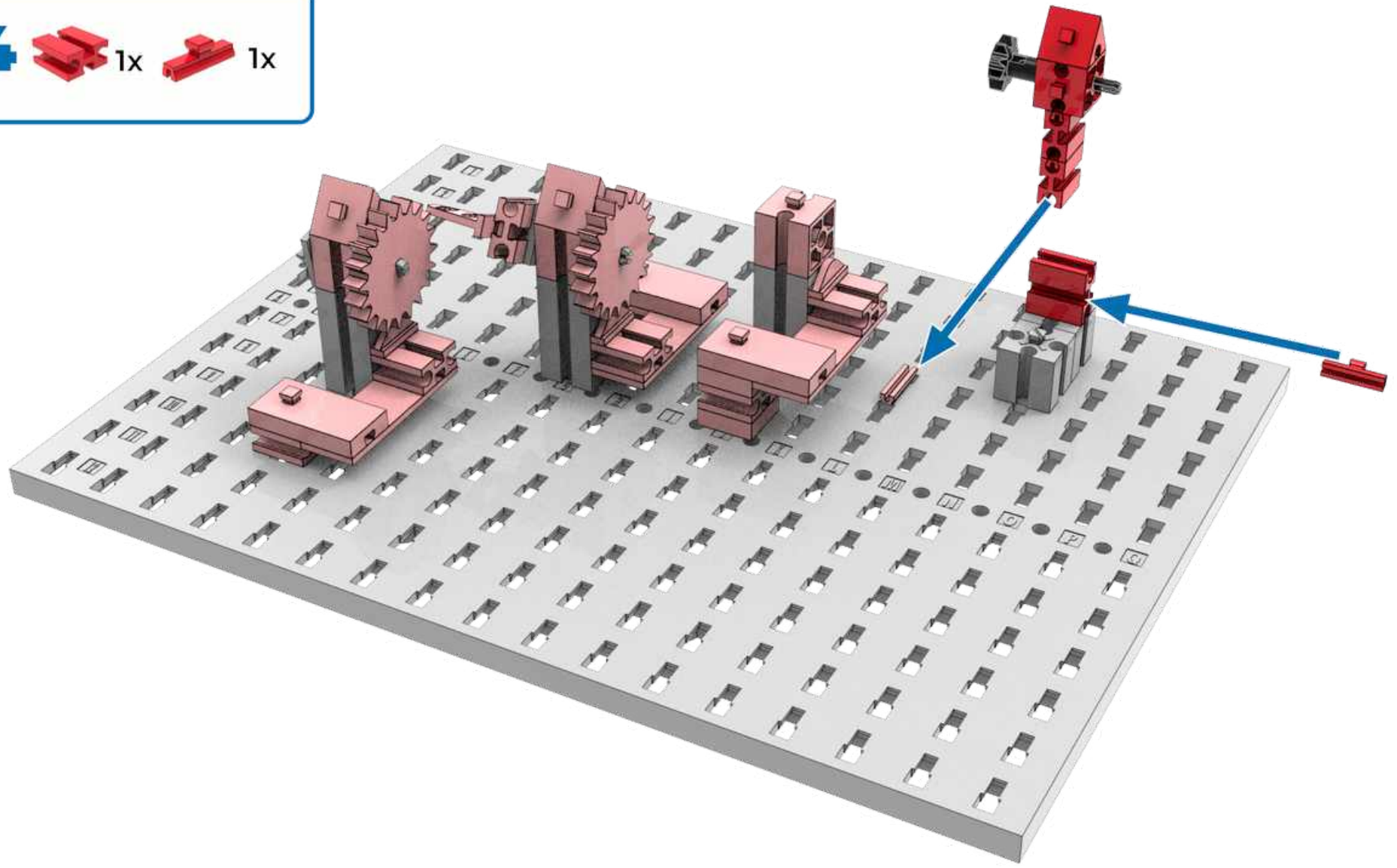

14  1x  1x

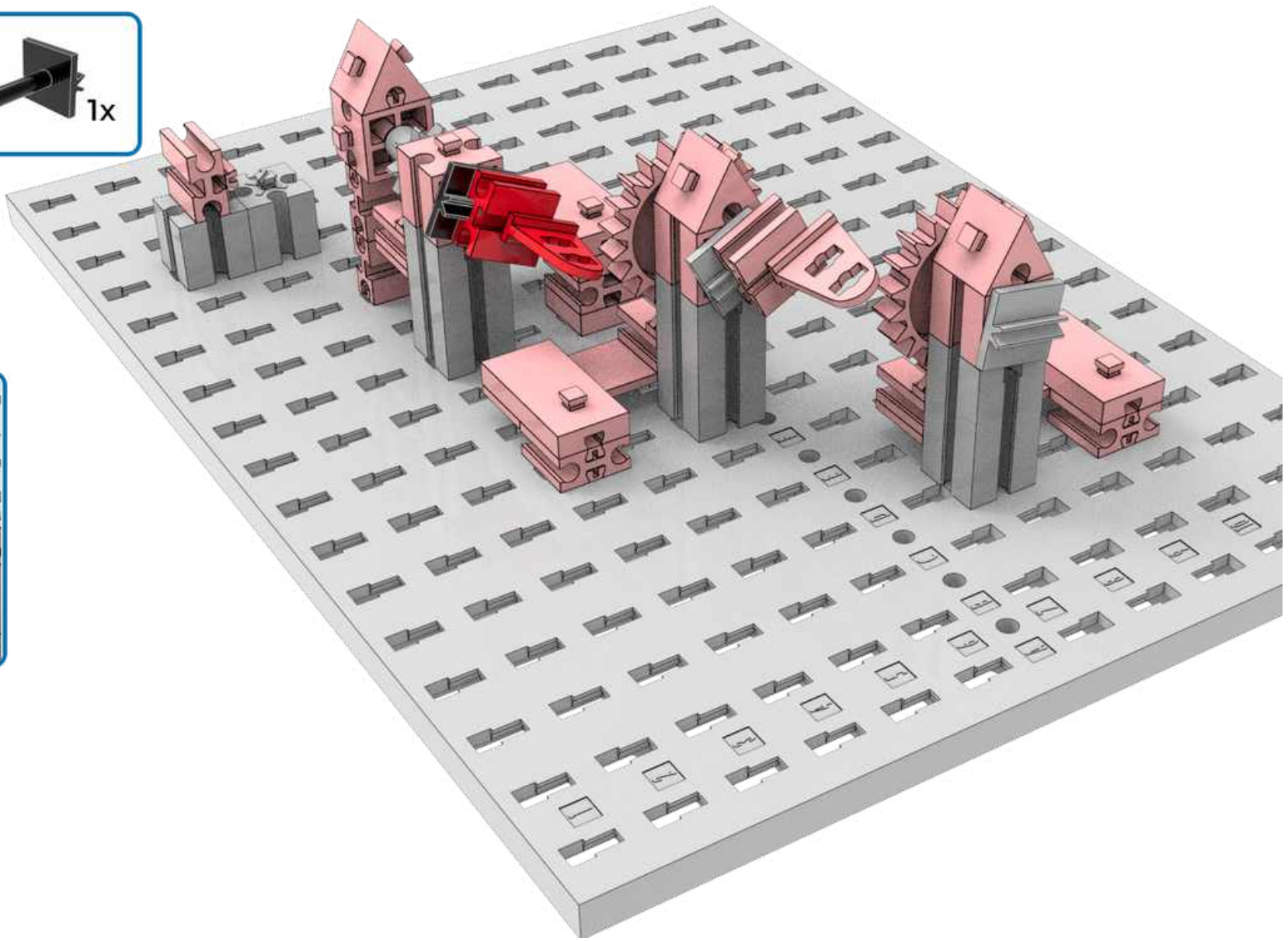
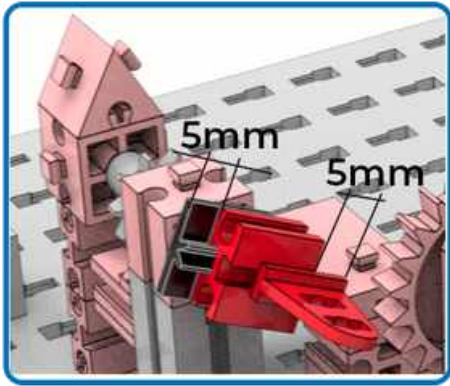

15  1x  1x  1x



16  3x  1x  1x

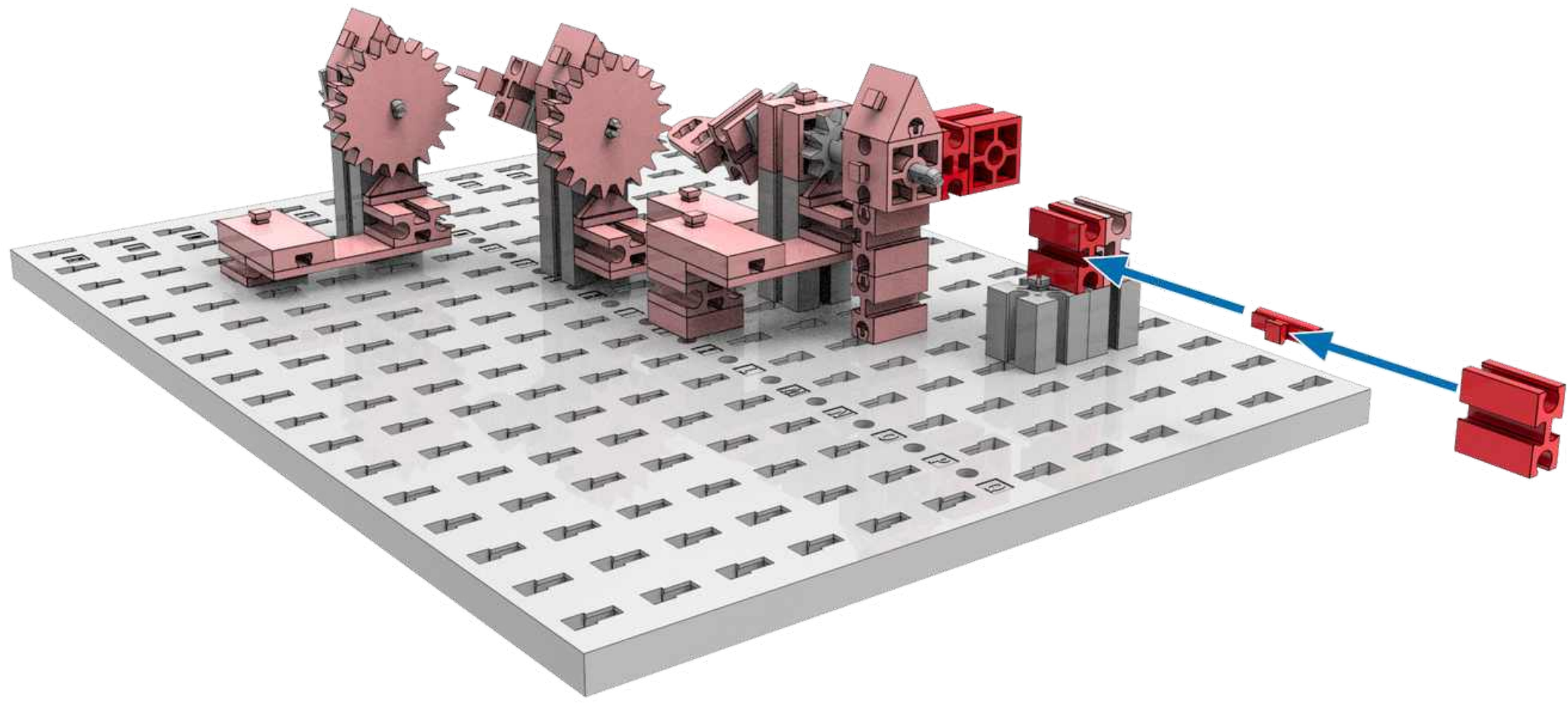

17  1x  30 2x  1x

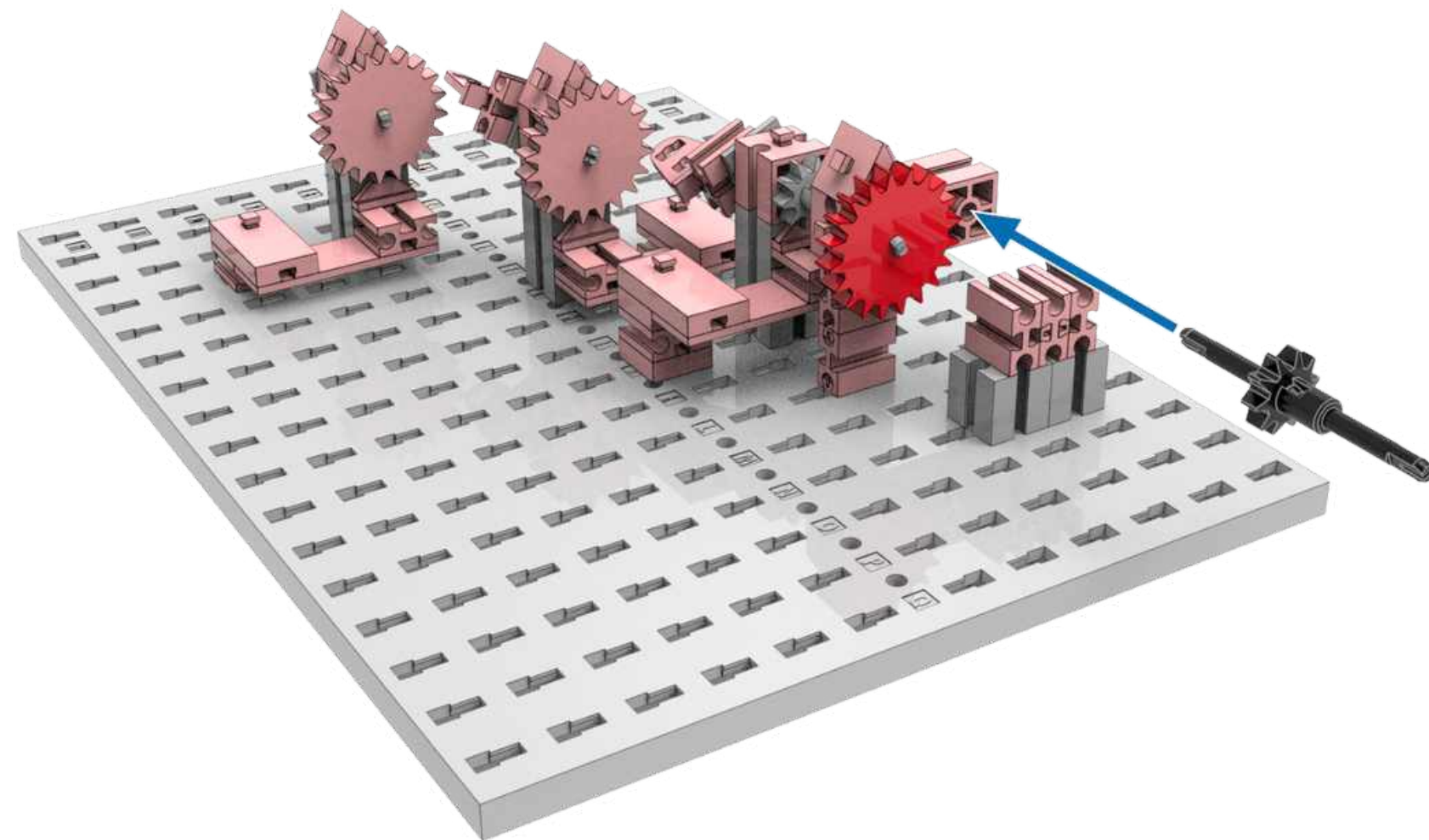

18  1x  1x  1x

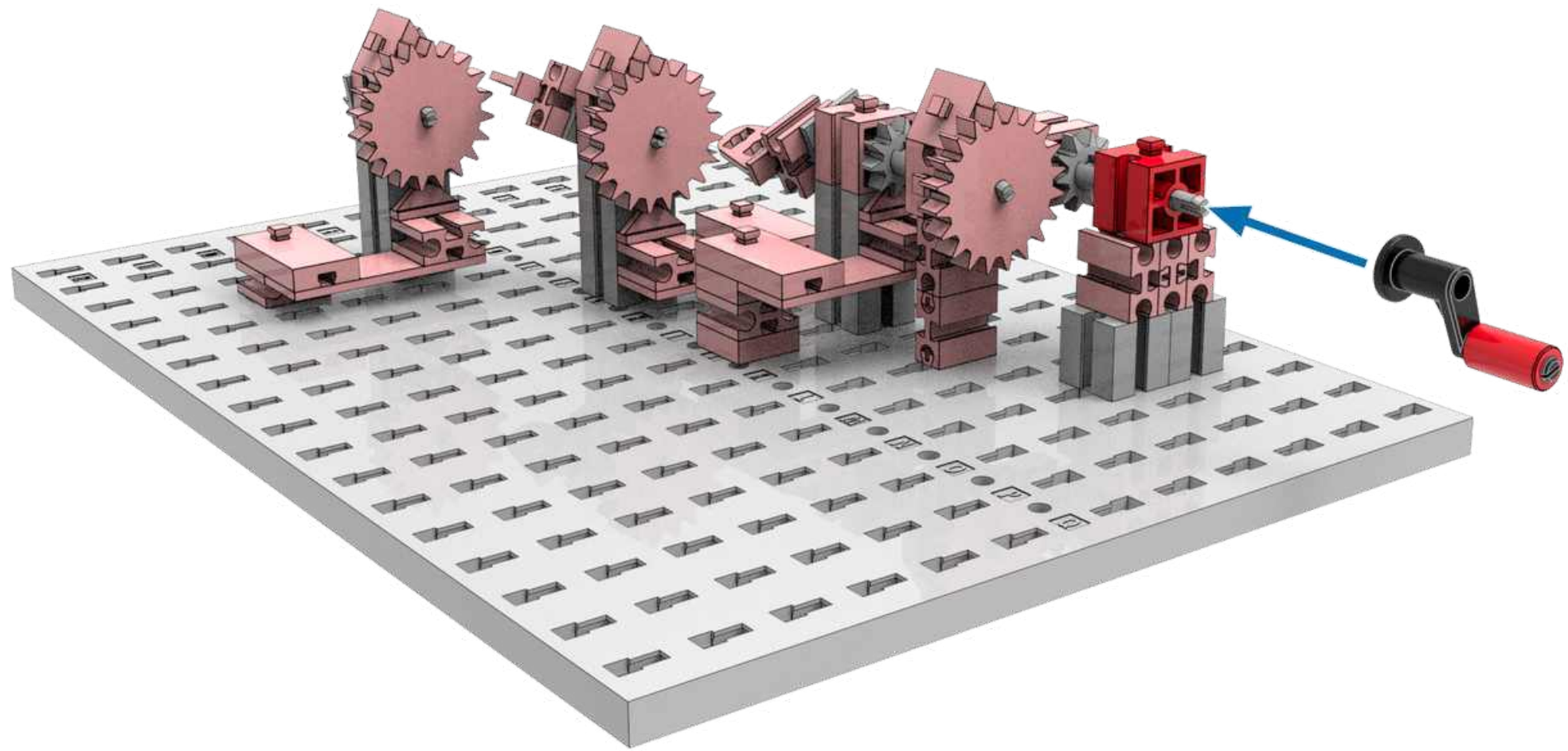

19



1x

2 3 4 5 6 7 8 9 0
1 2 3 4 5 6 7 8 9 0
1 2 3 4 5 6 7 8 9 0

1x

2 3 4 5 6 7 8 9 0
1 2 3 4 5 6 7 8 9 0
1 2 3 4 5 6 7 8 9 0

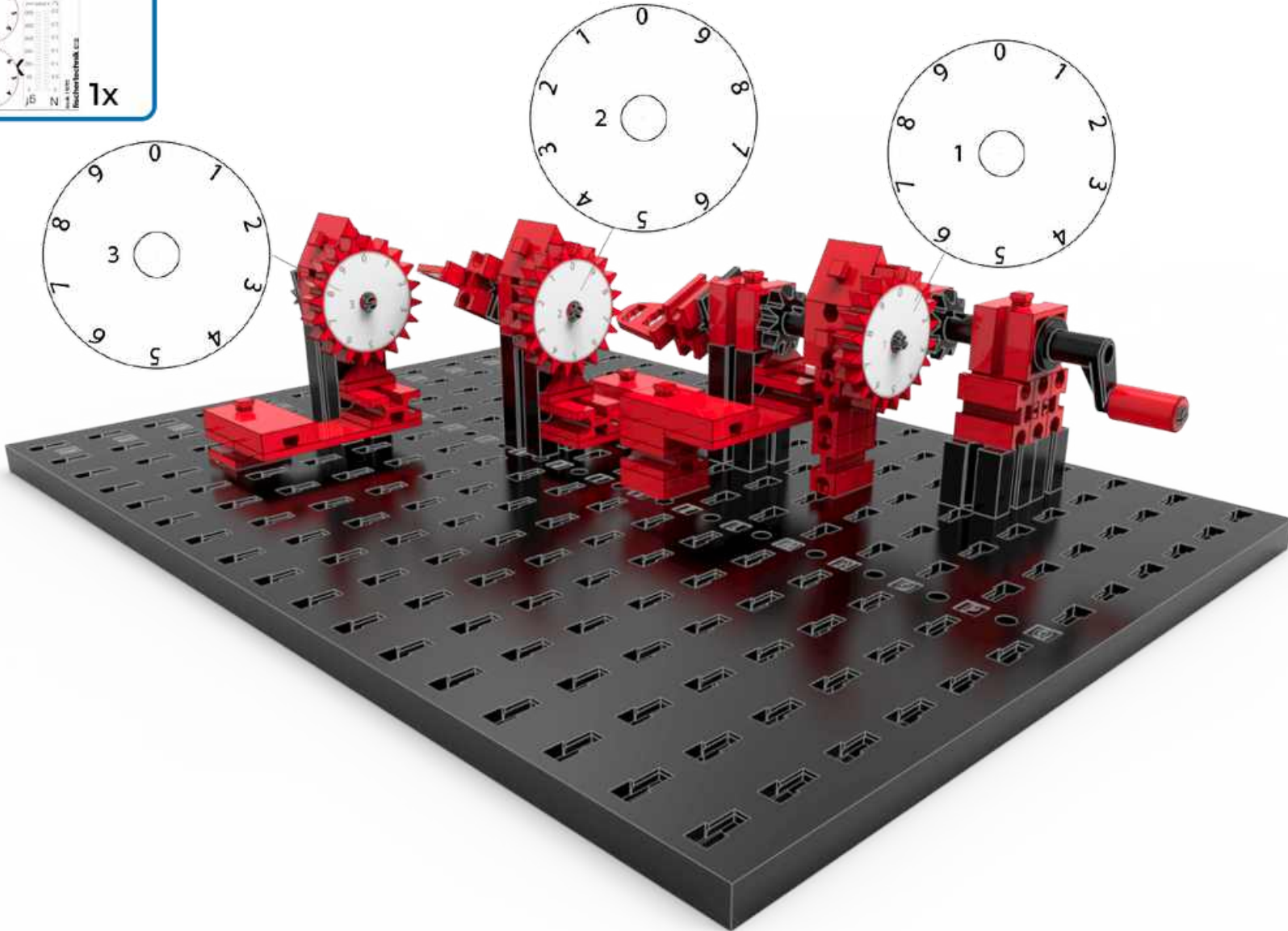



Exzenterpresse

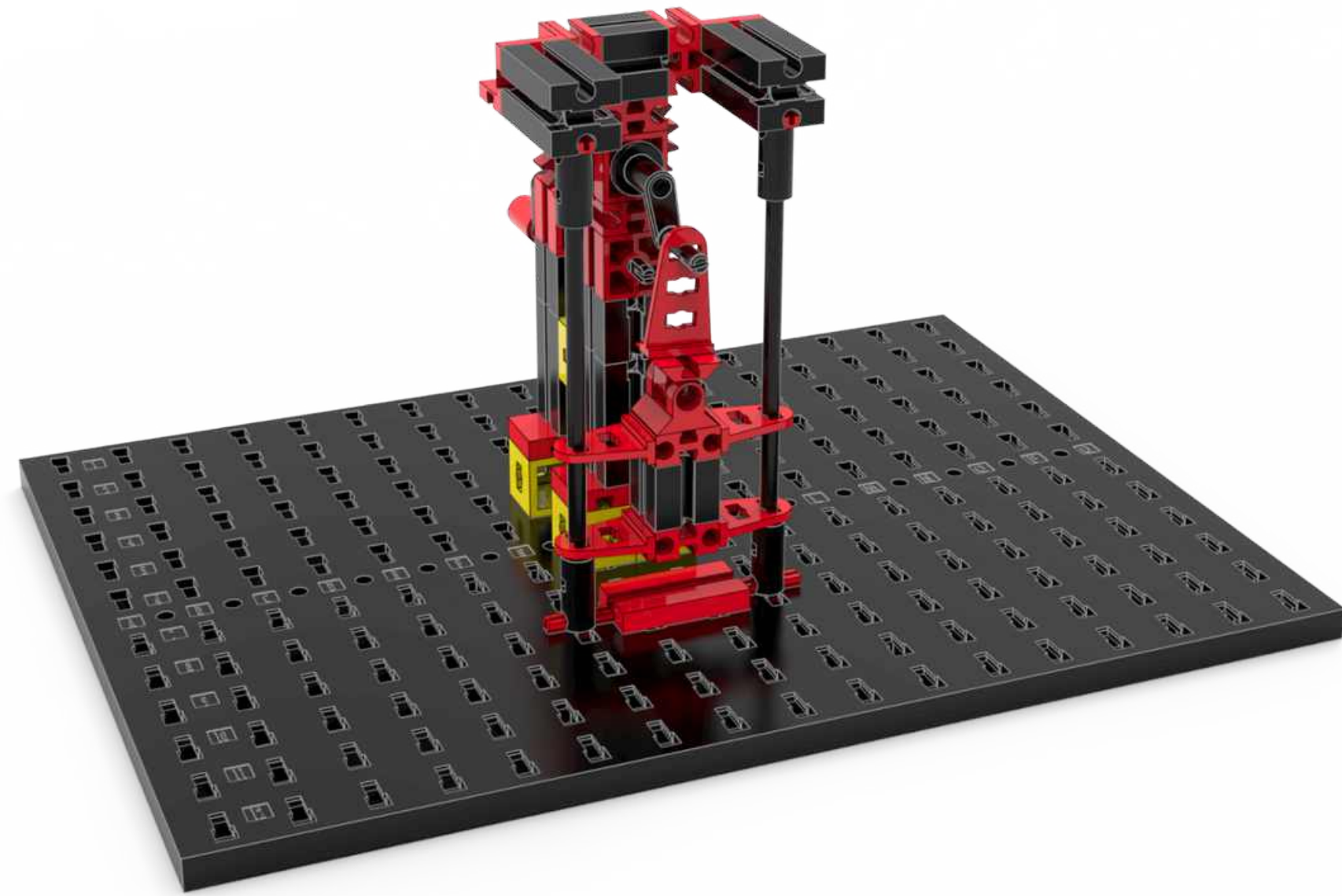

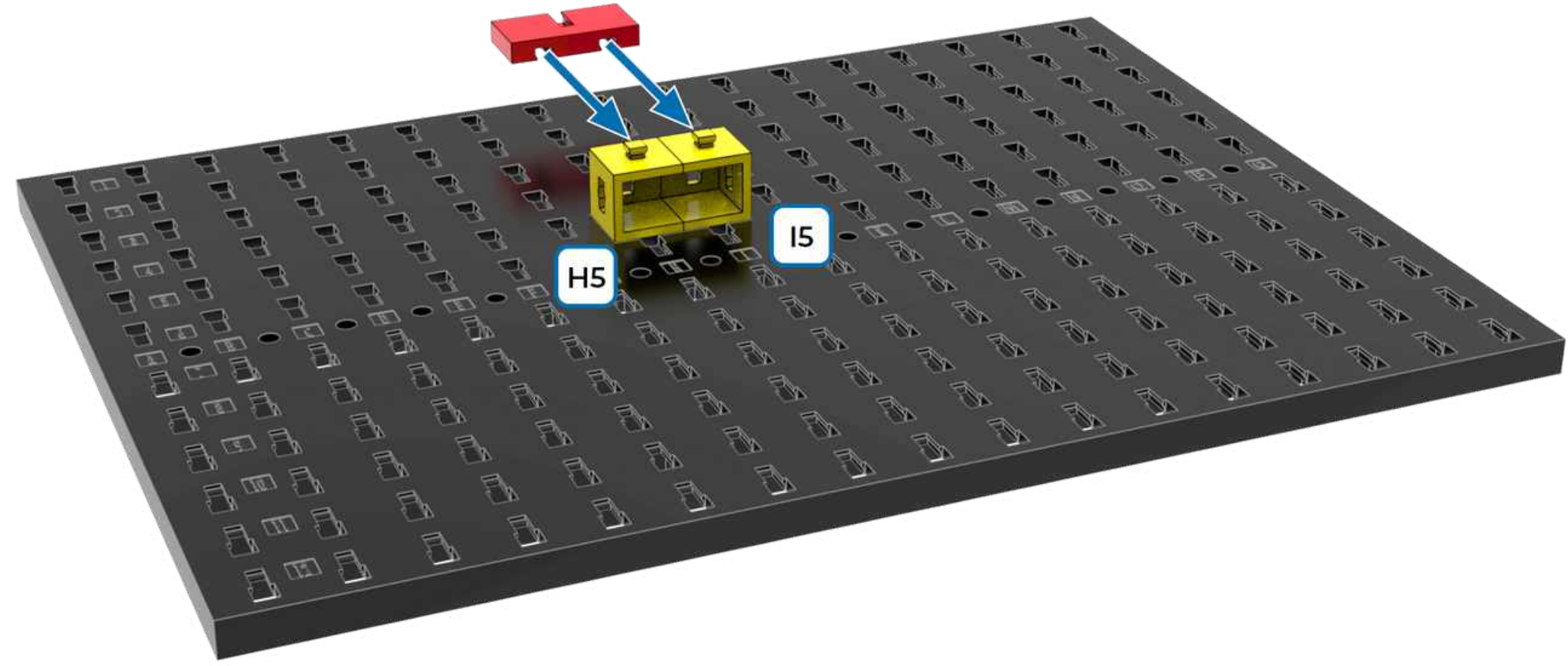
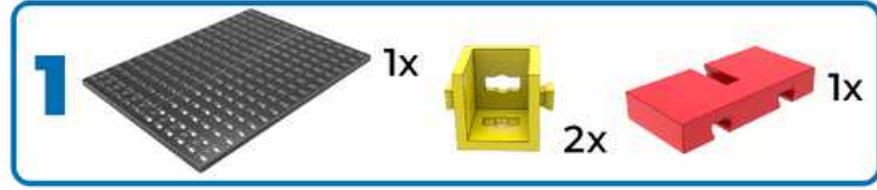



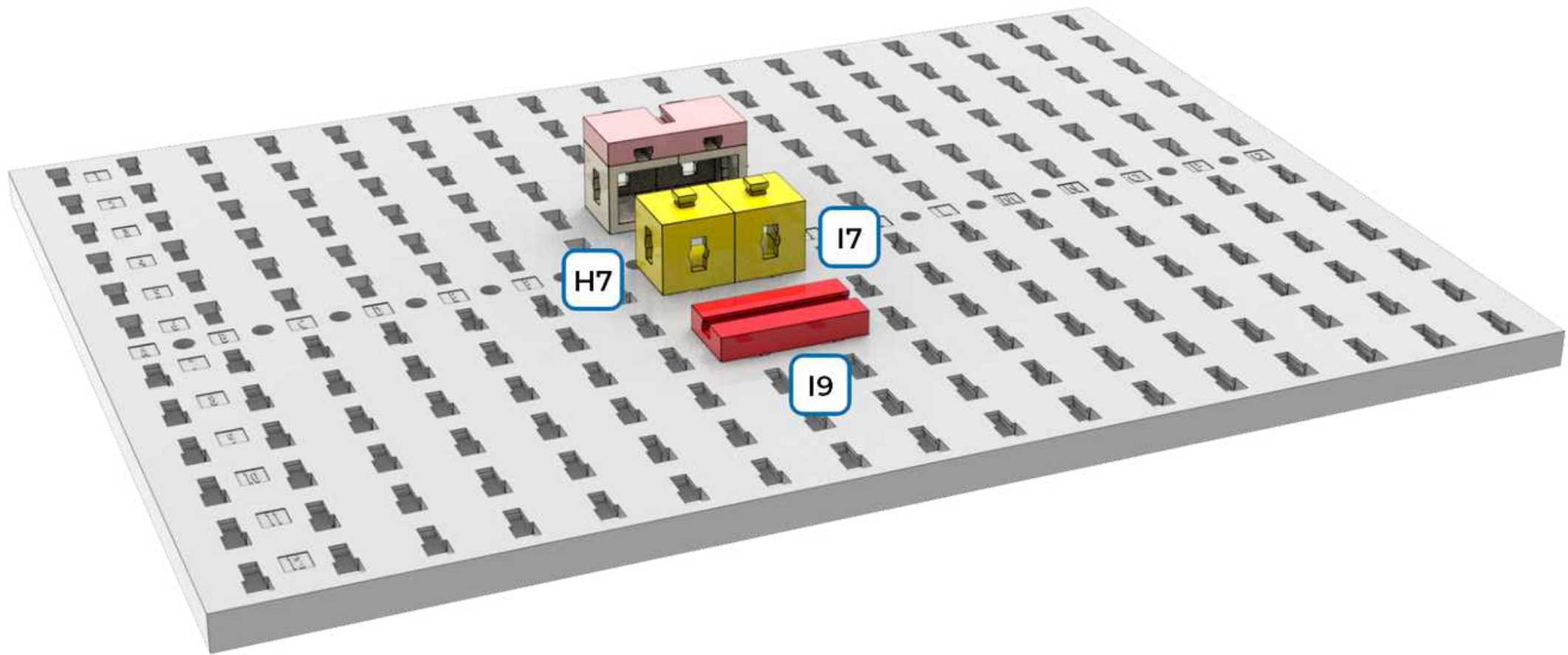

2  1x  2x





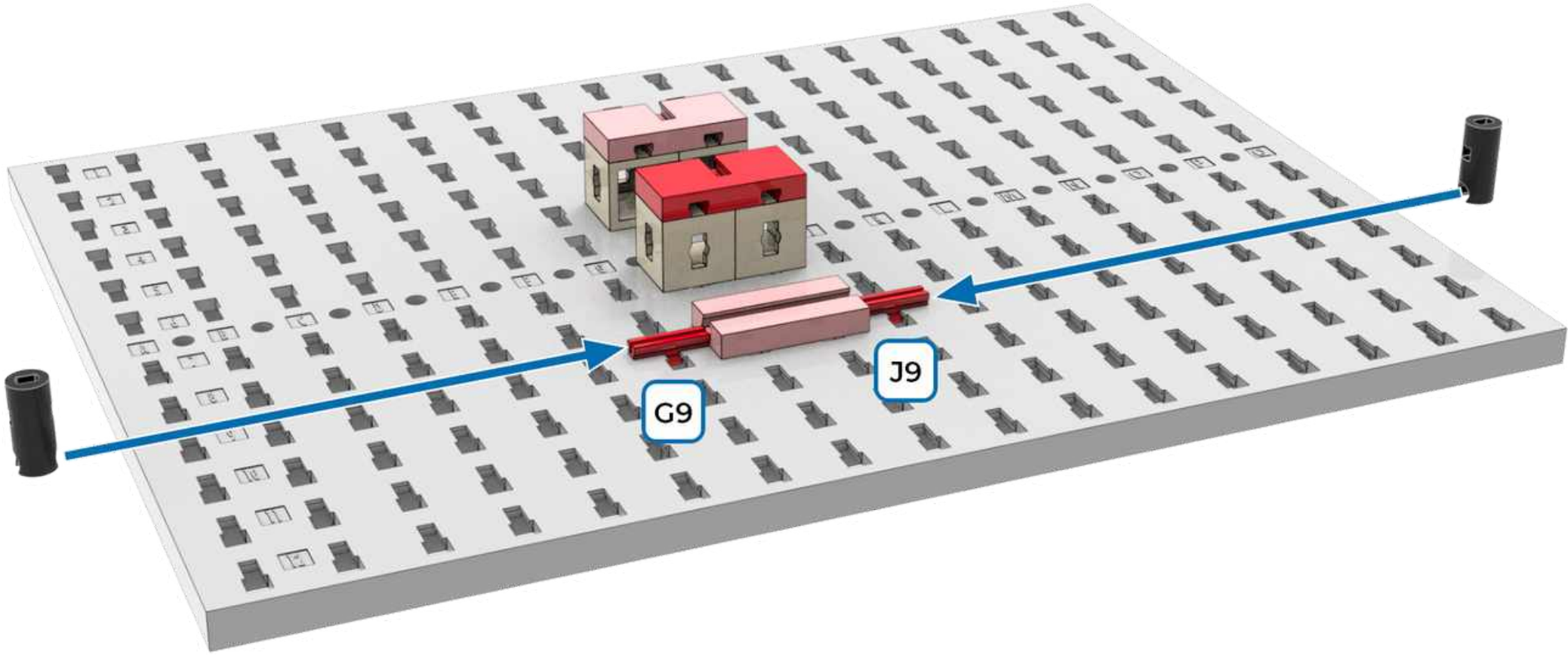

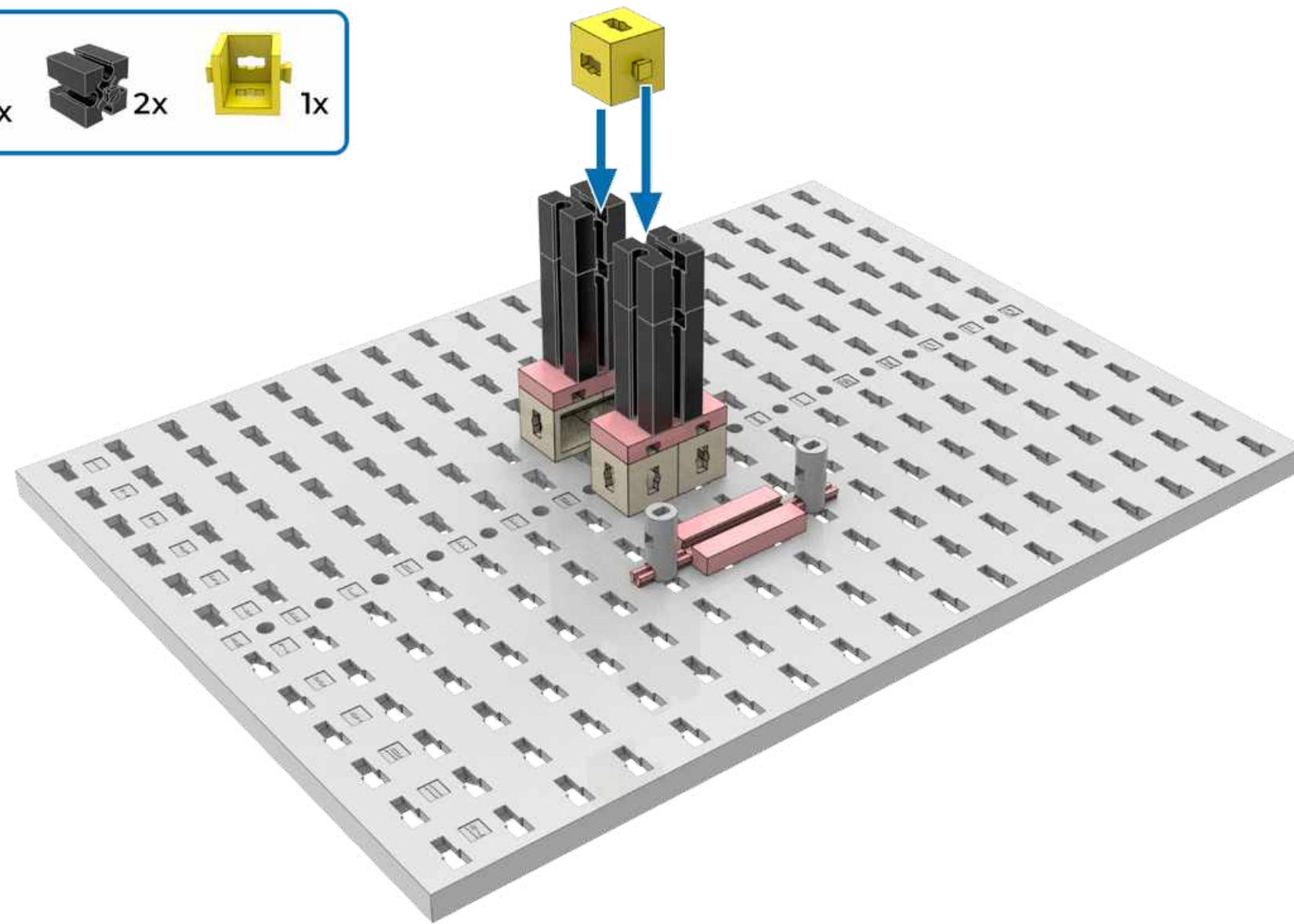
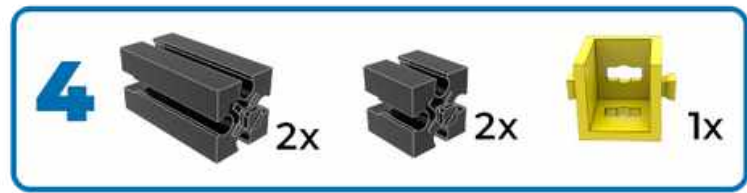
3  1x  2x  2x



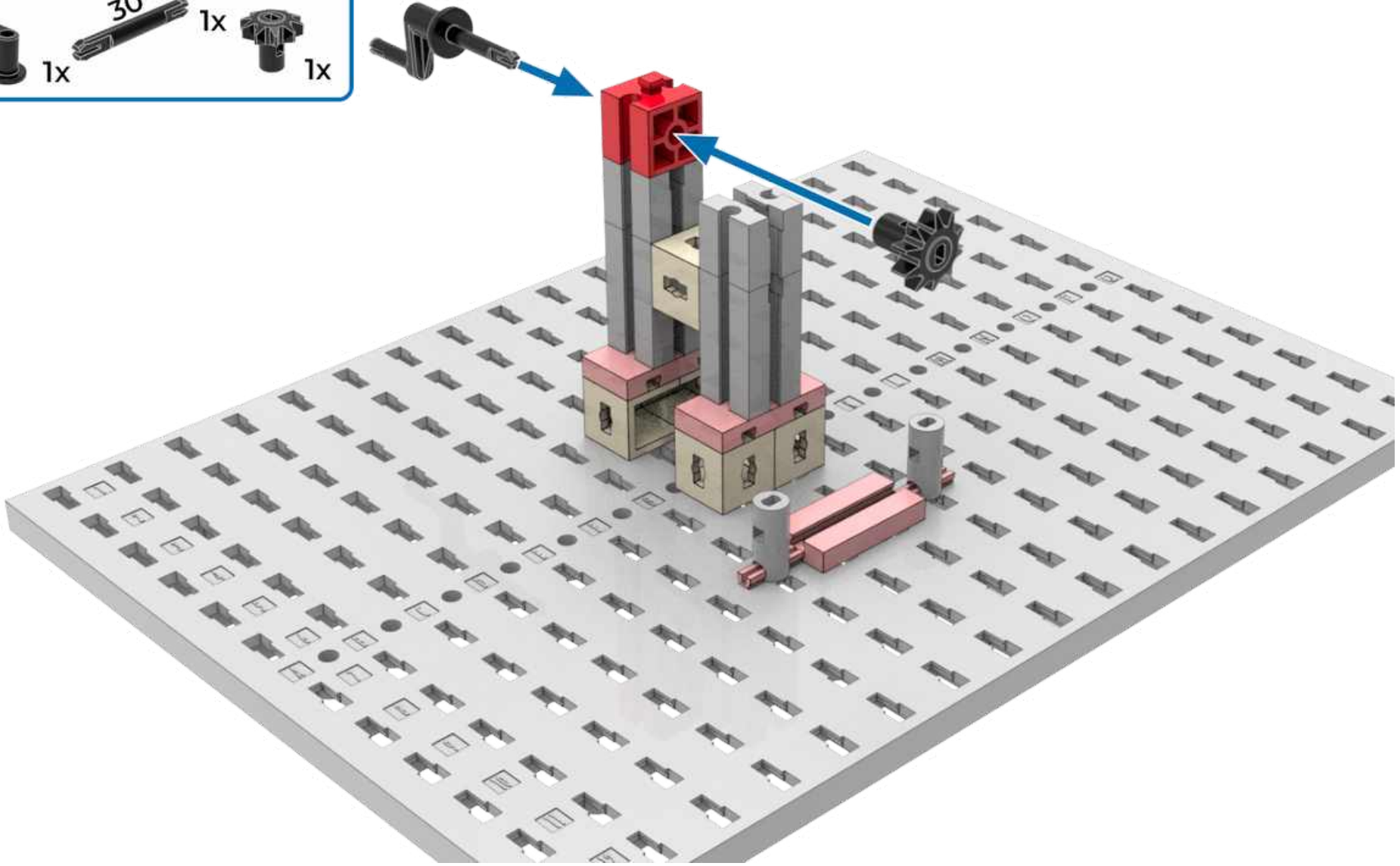

5 1x  1x  1x  1x  1x



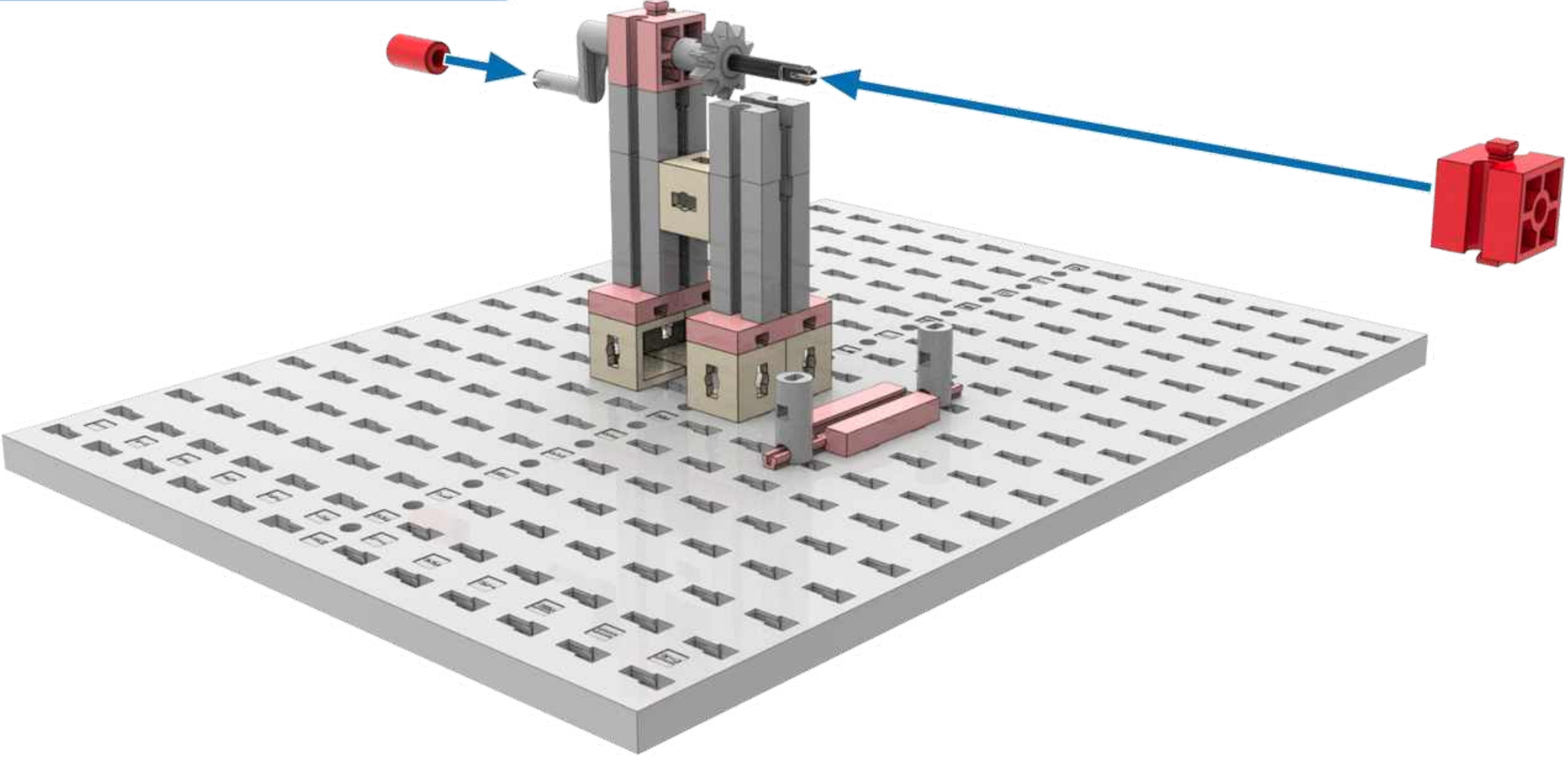

6  30 1x  1x  1x



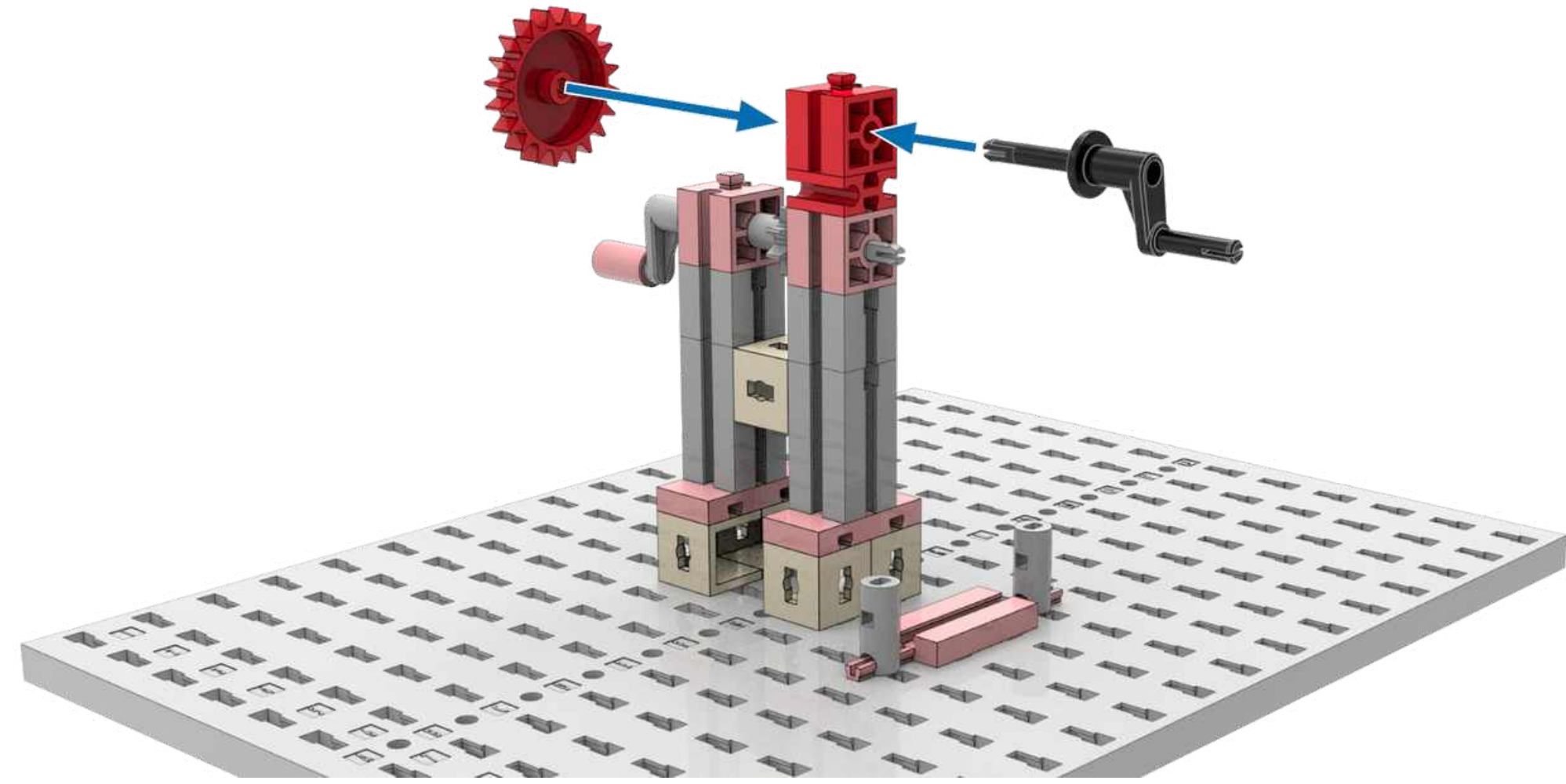

7  1x  1x  1x  30 1x  1x



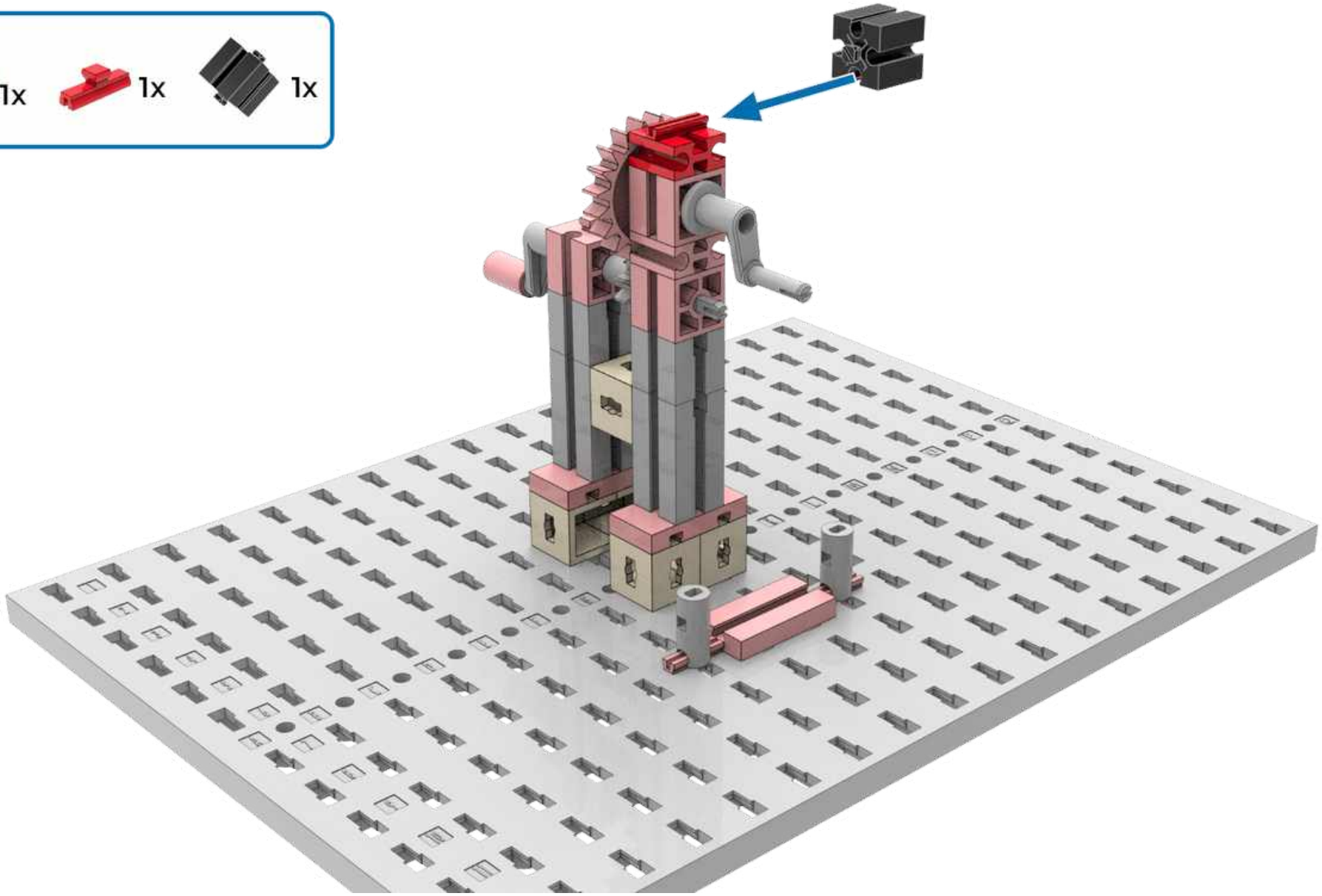

8  1x  1x  1x

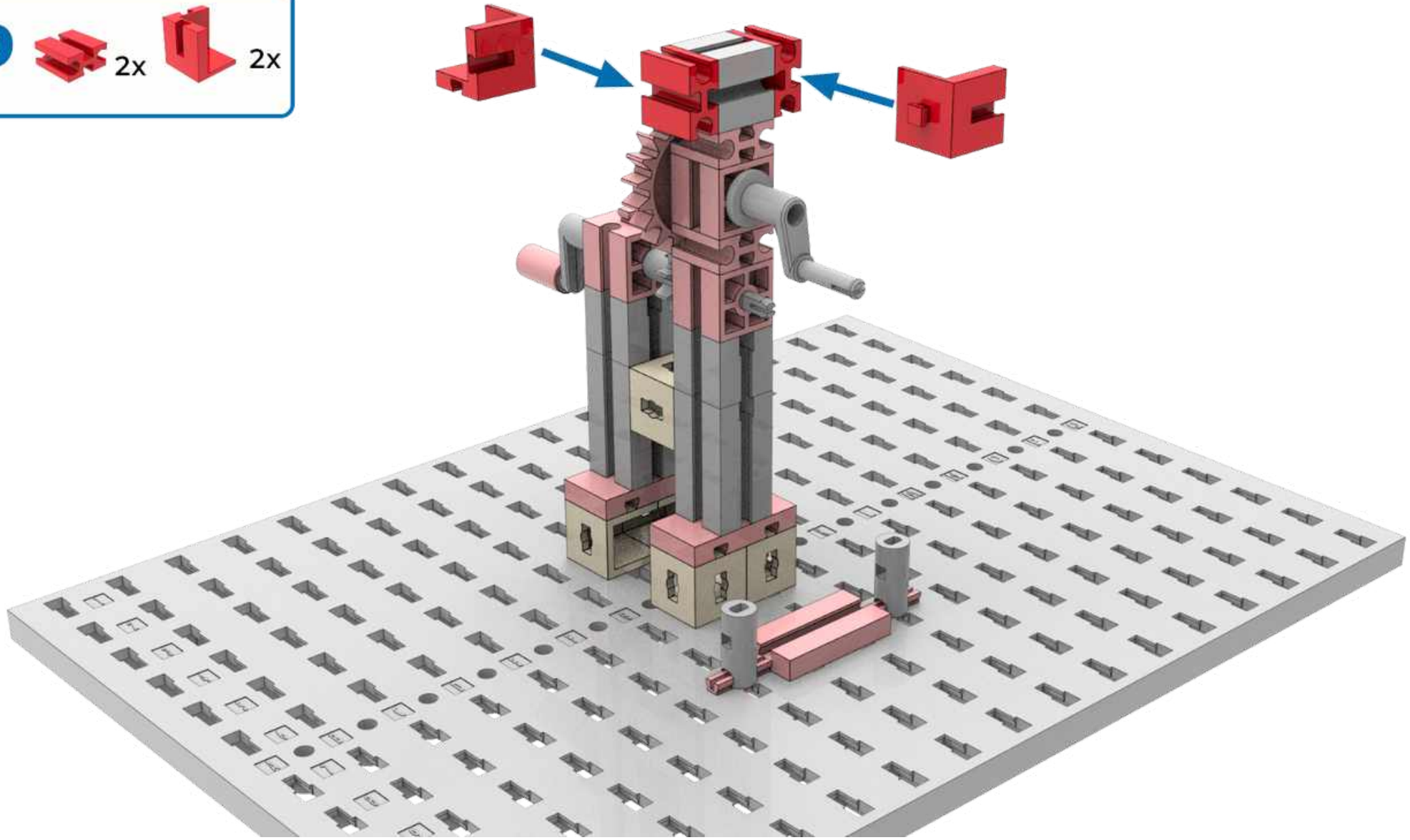

9  2x  2x



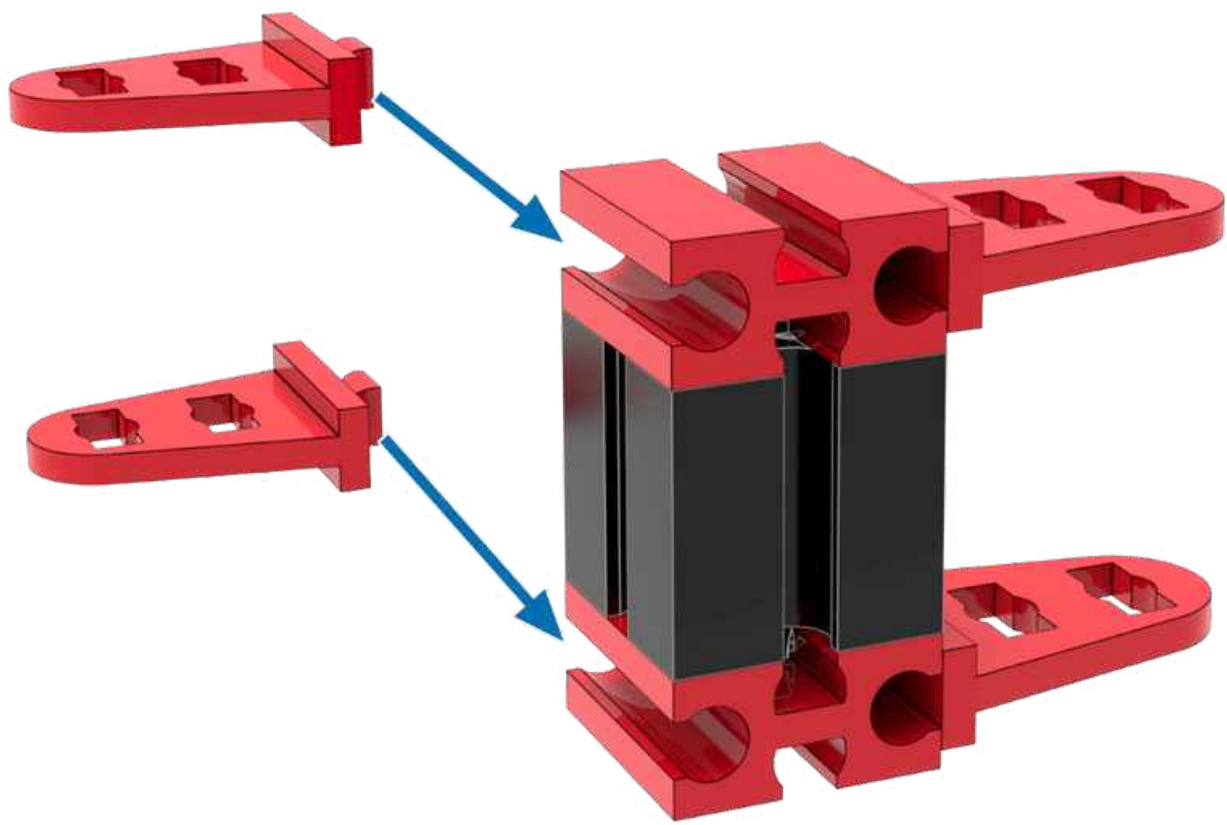

10  1x  2x  4x



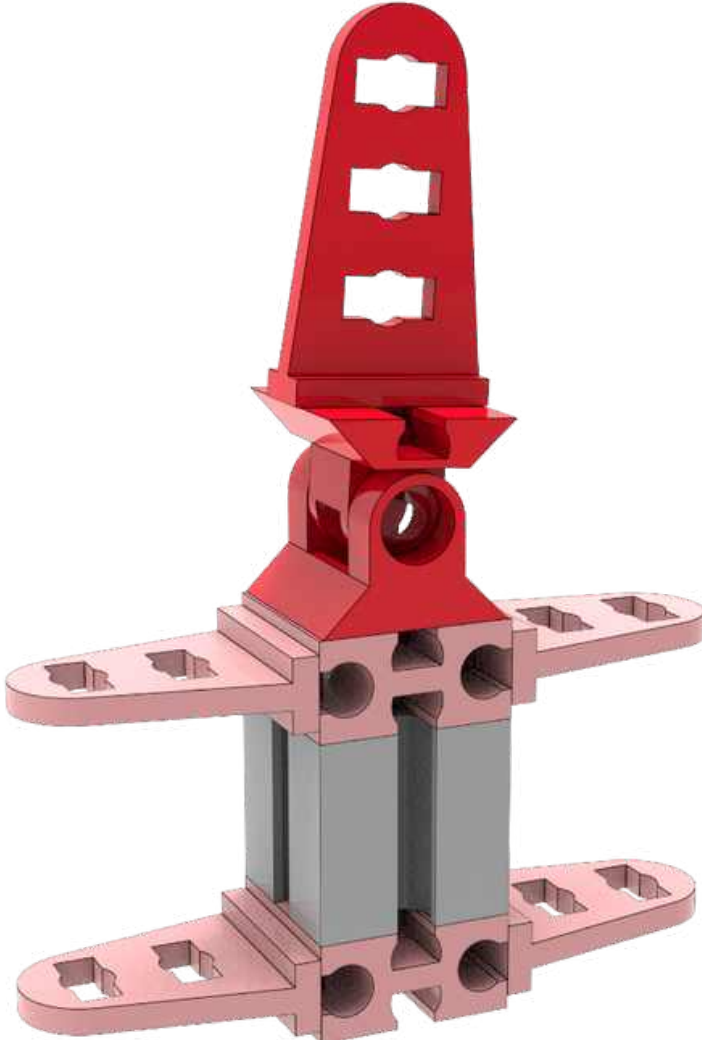
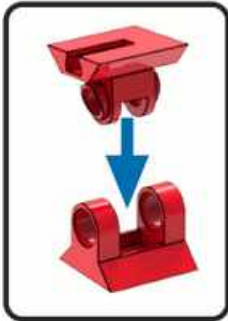

11  1x  2x  2x

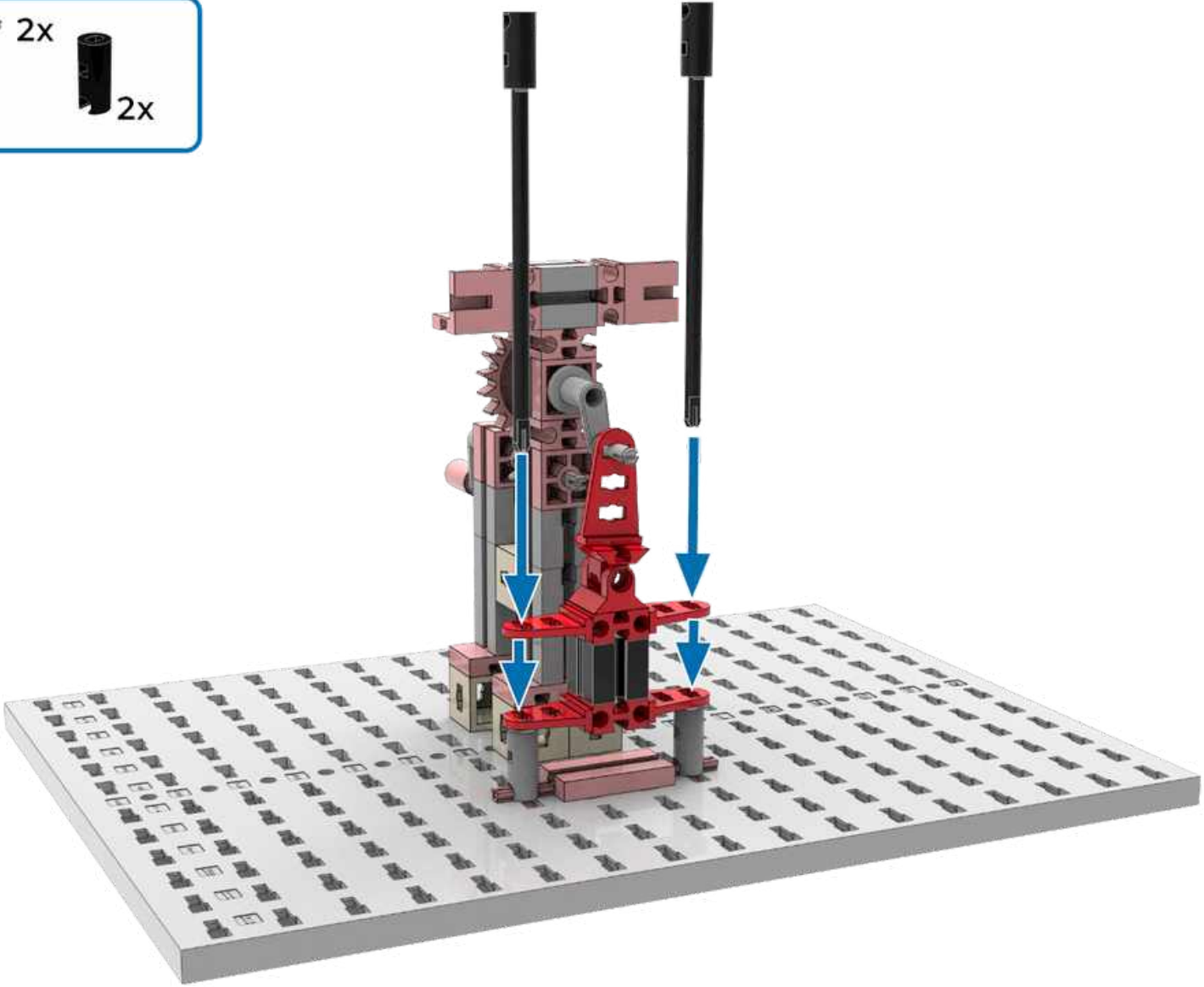

12 90 2x  2x 



13  2x  2x

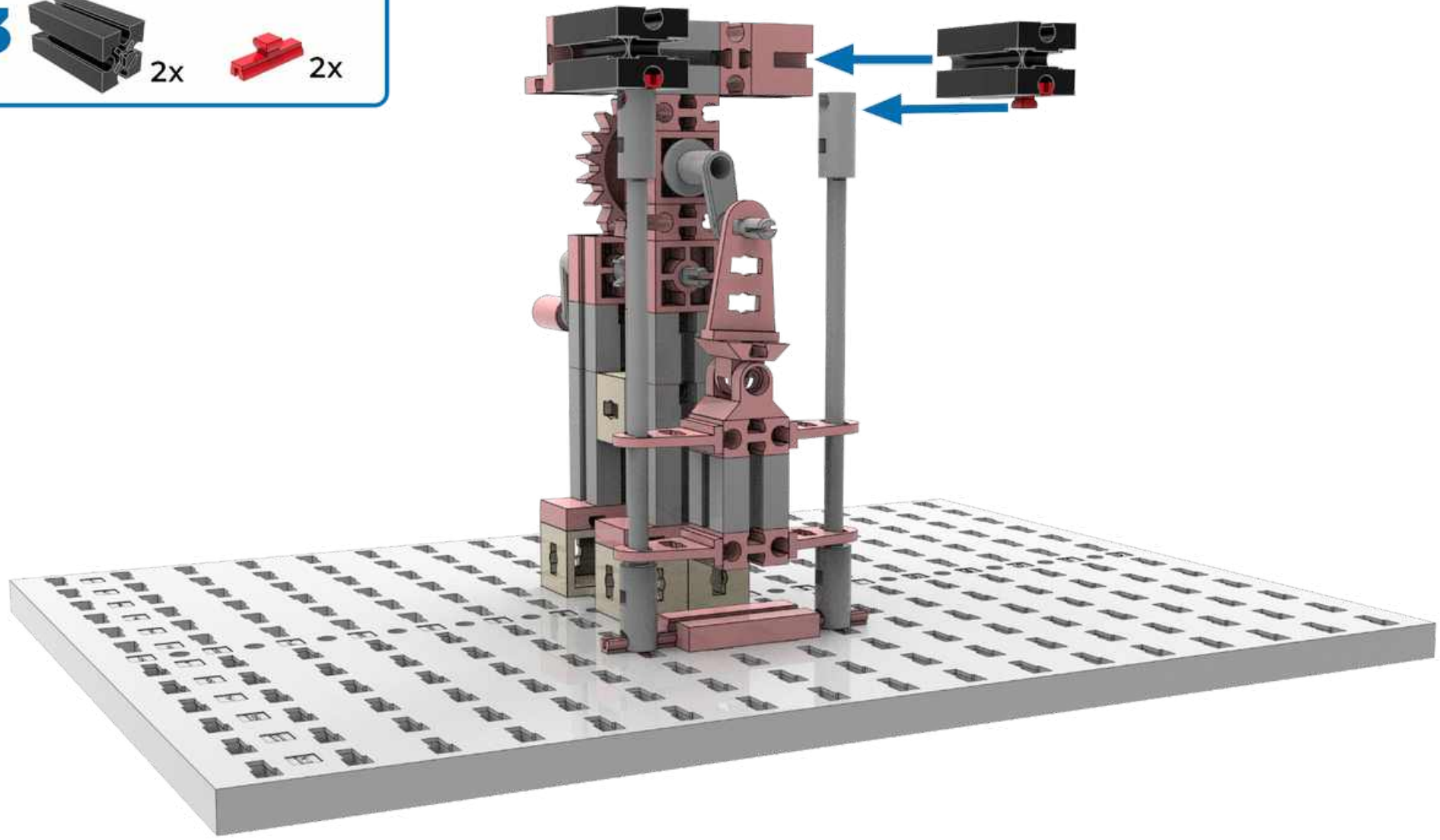



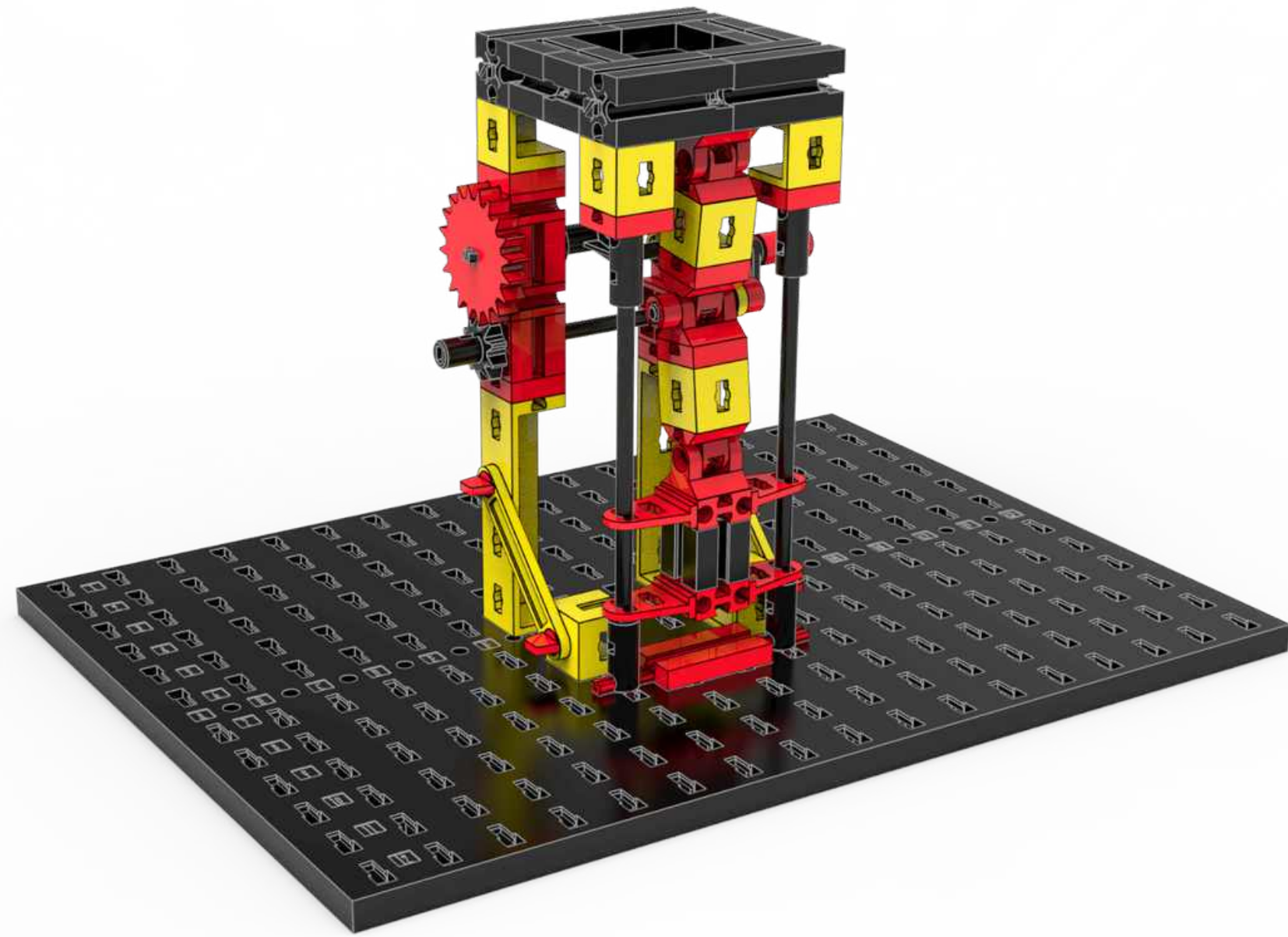

Kniehebelpresse



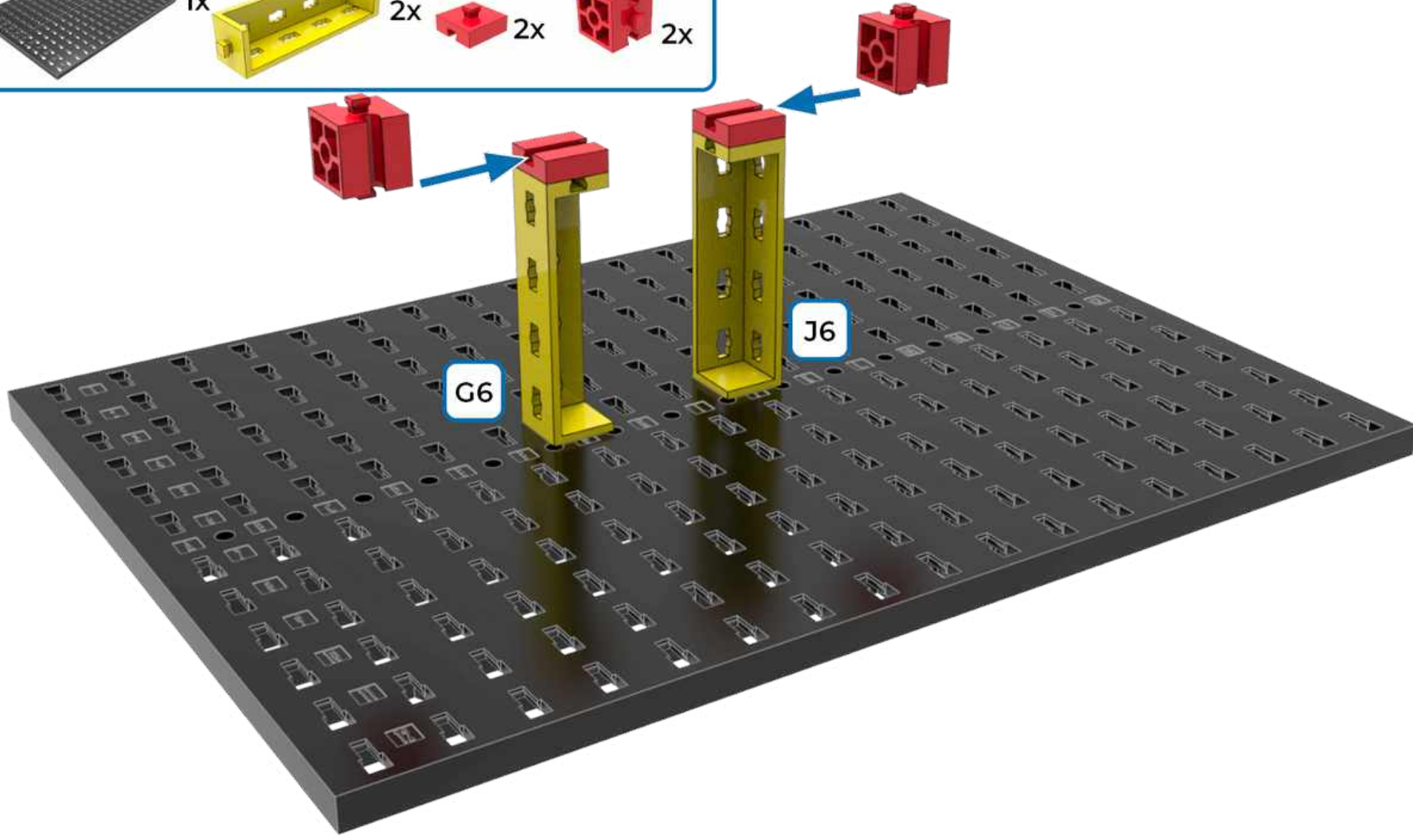

1 1x 2x 2x 2x 2x



2  1x  2x  1x

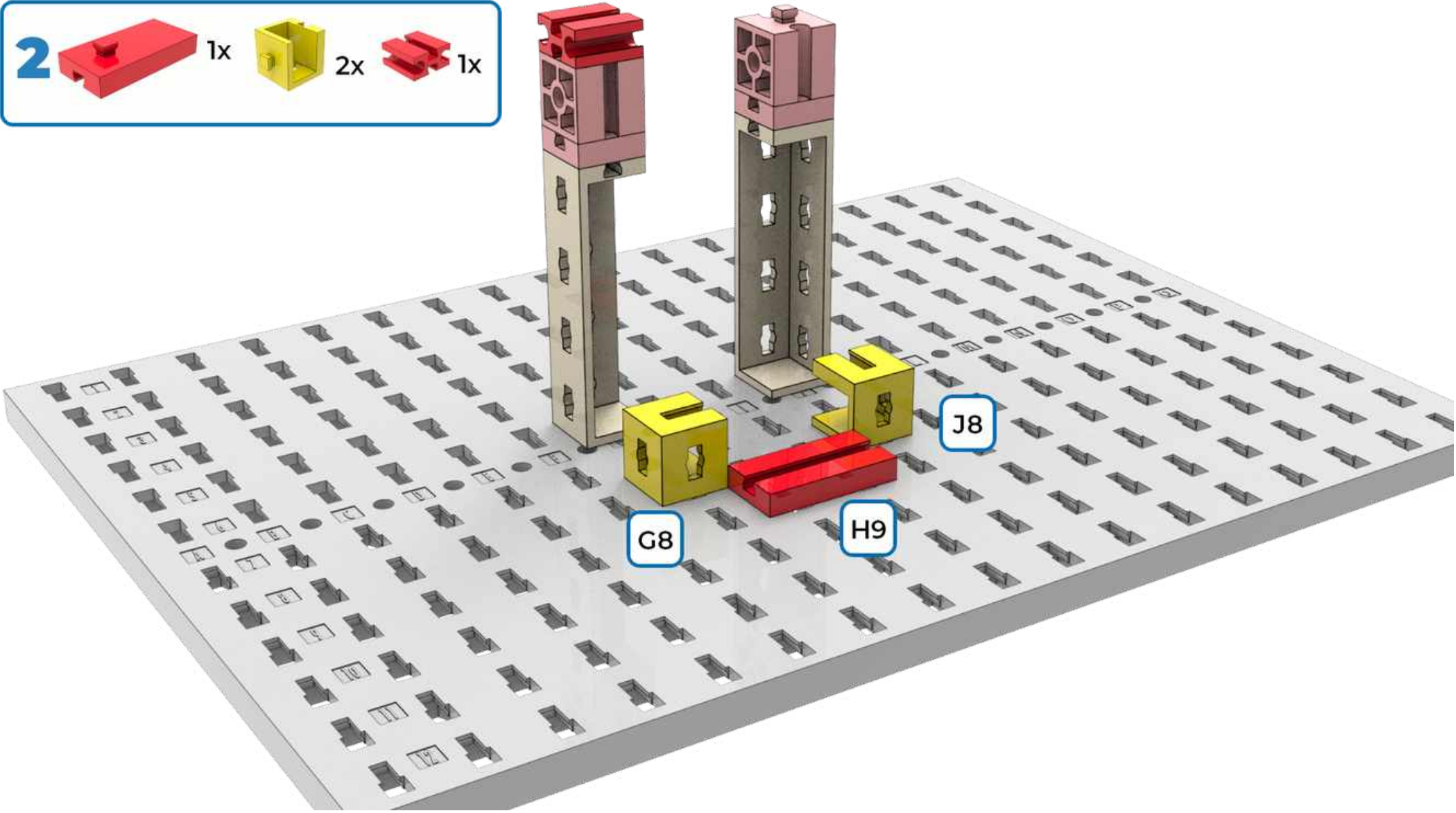

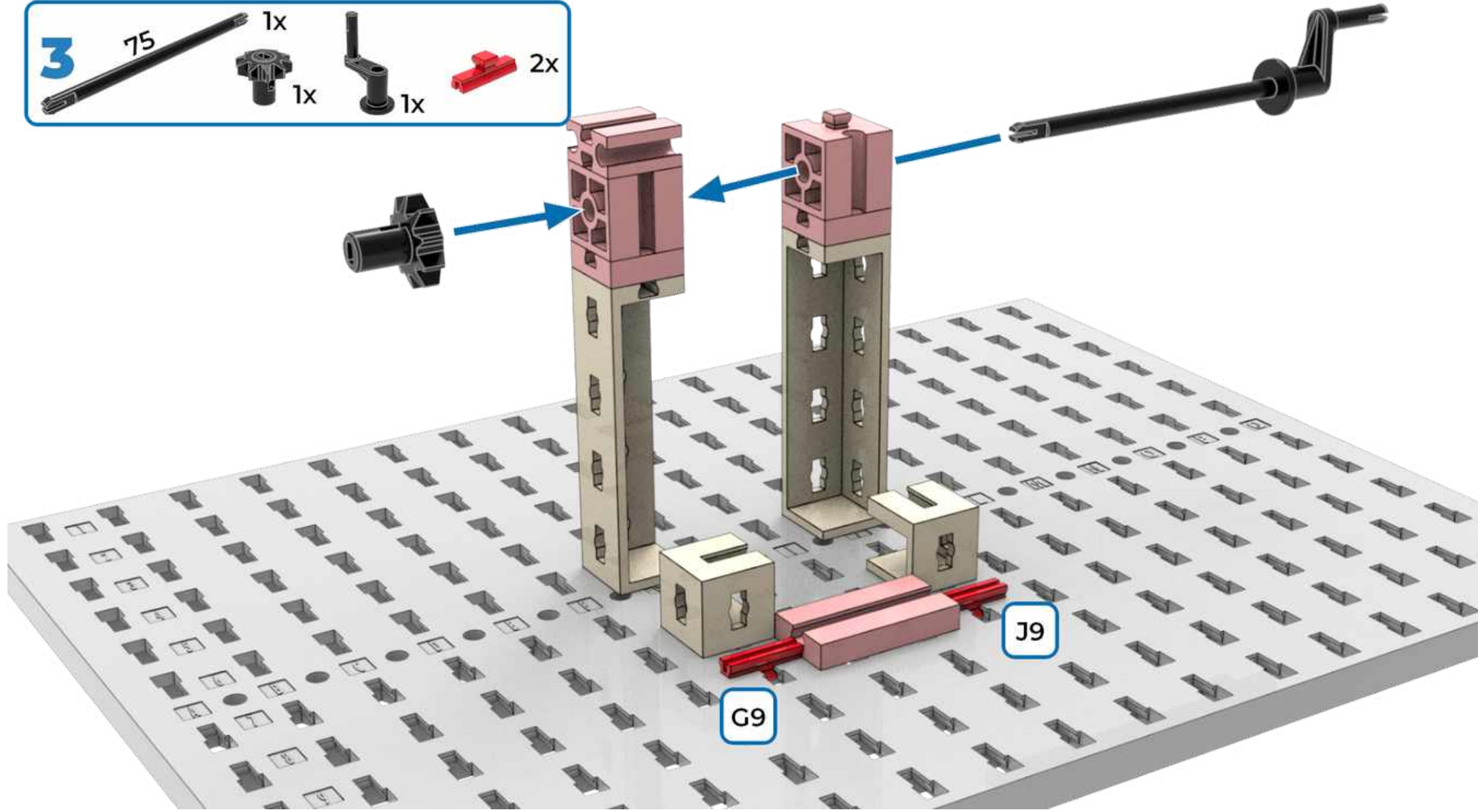

3 75 1x 1x 1x 2x

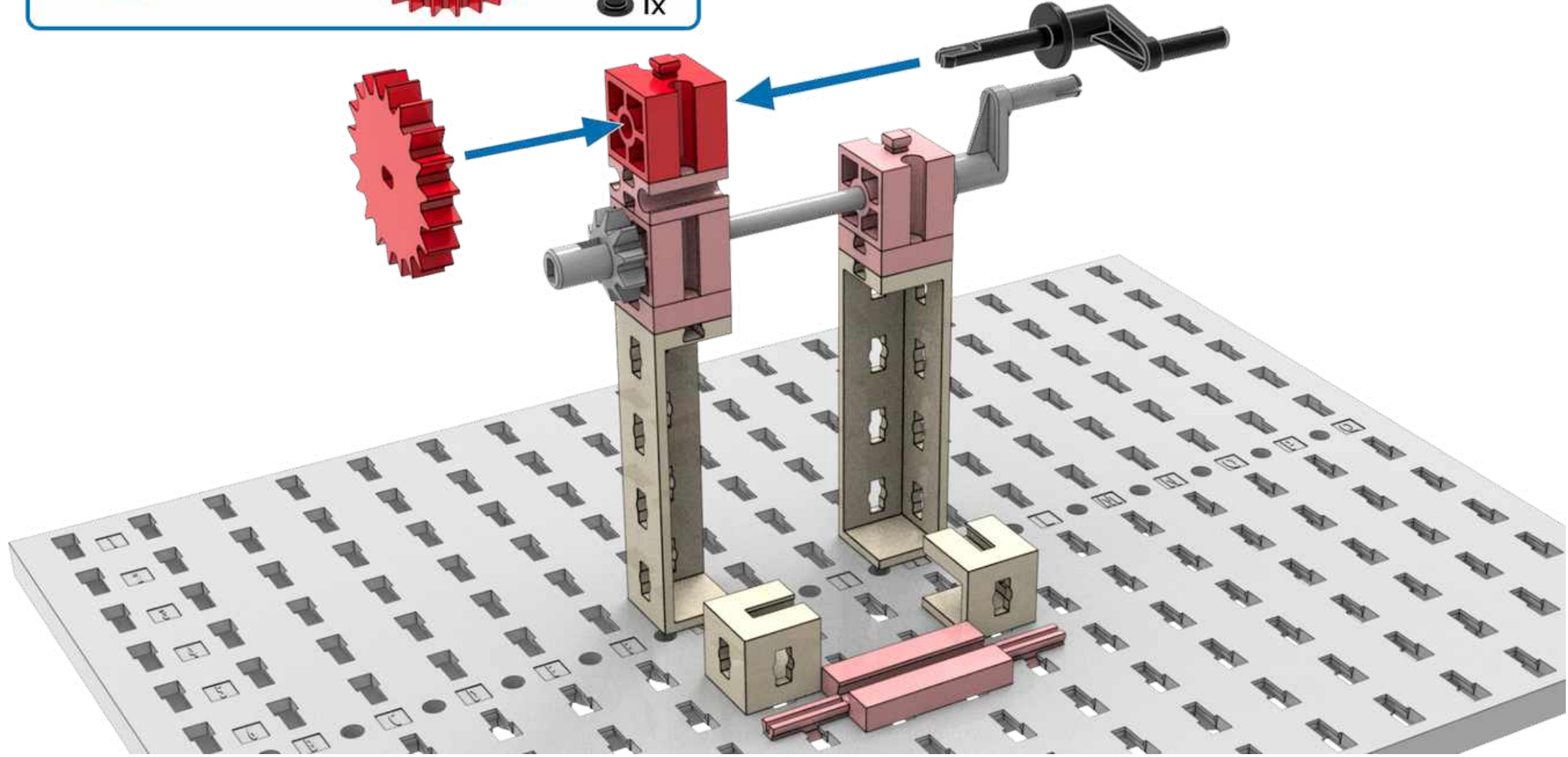

4 1x 30 1x 1x 1x



- 5**  3x  1x  1x

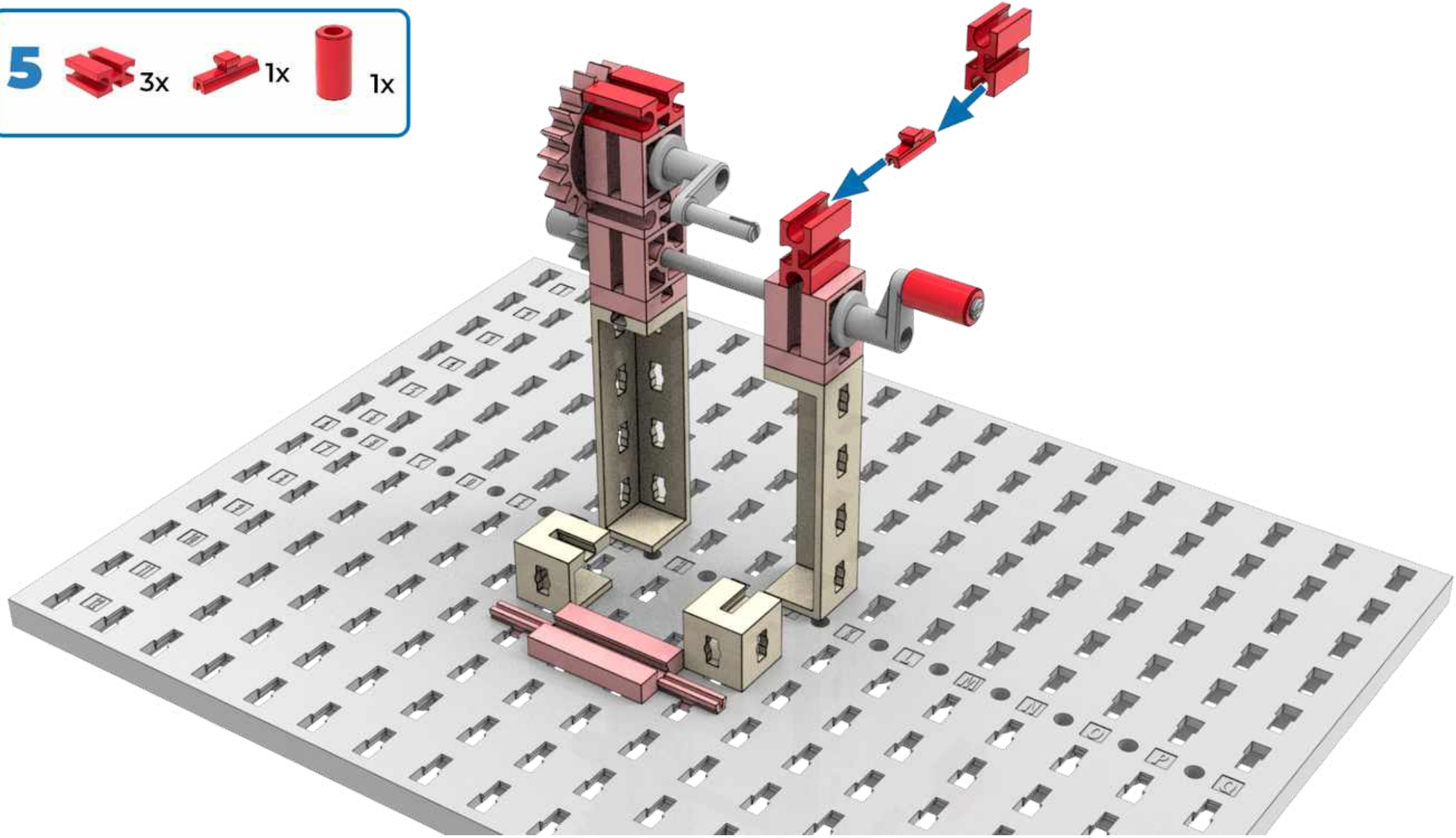

6 42,4 2x 4 4x 2x 2x

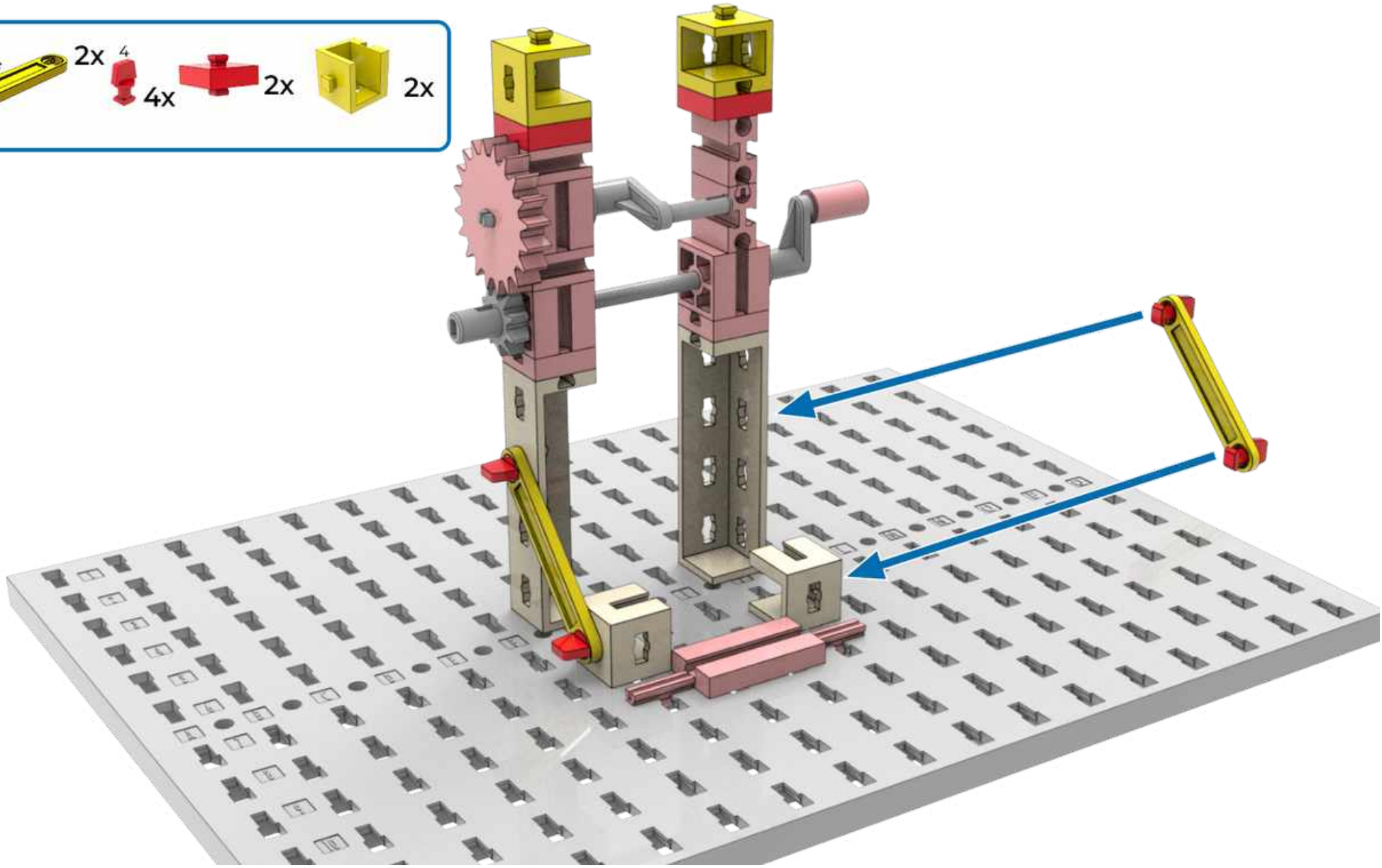



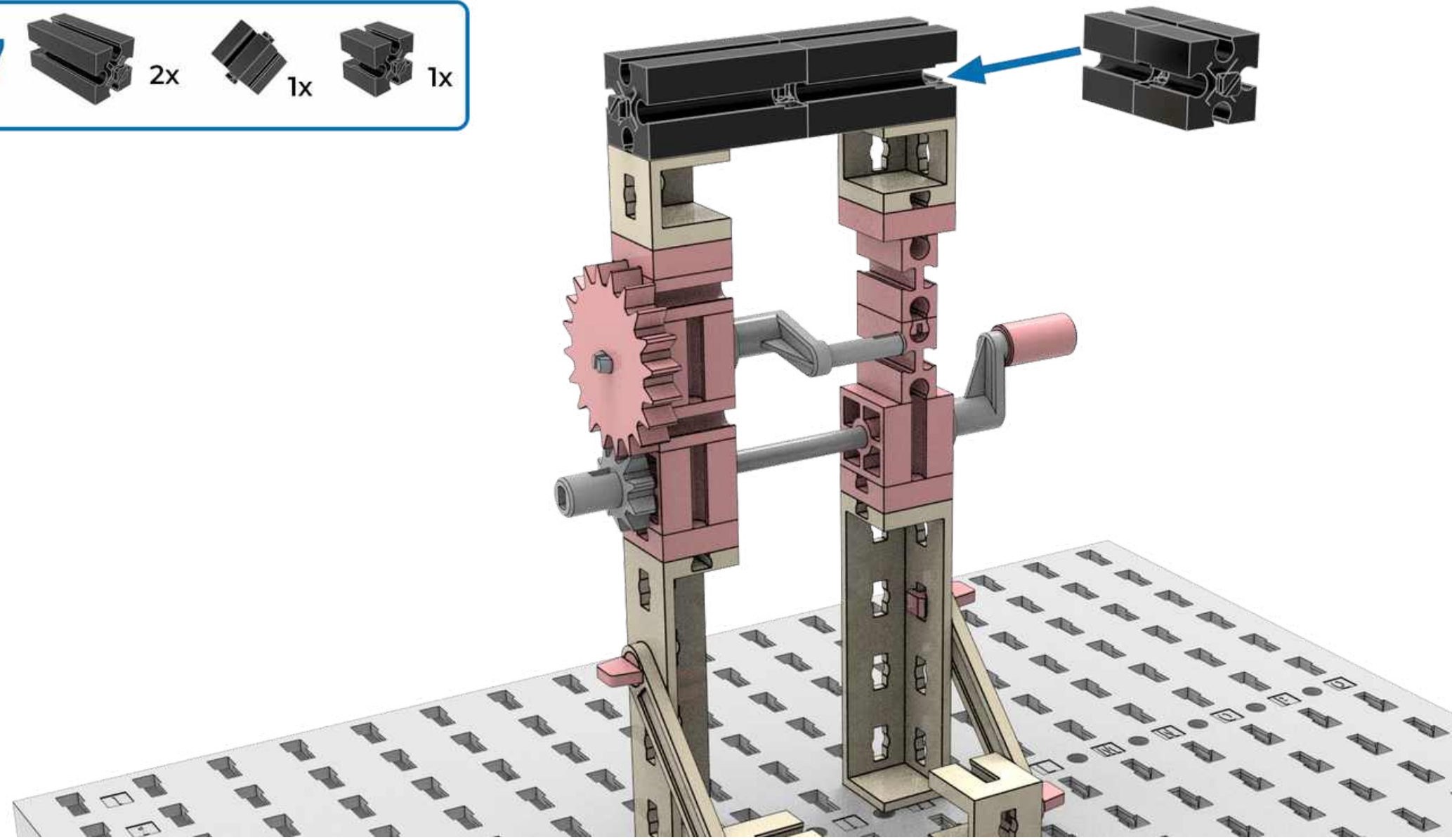

7  2x  1x  1x

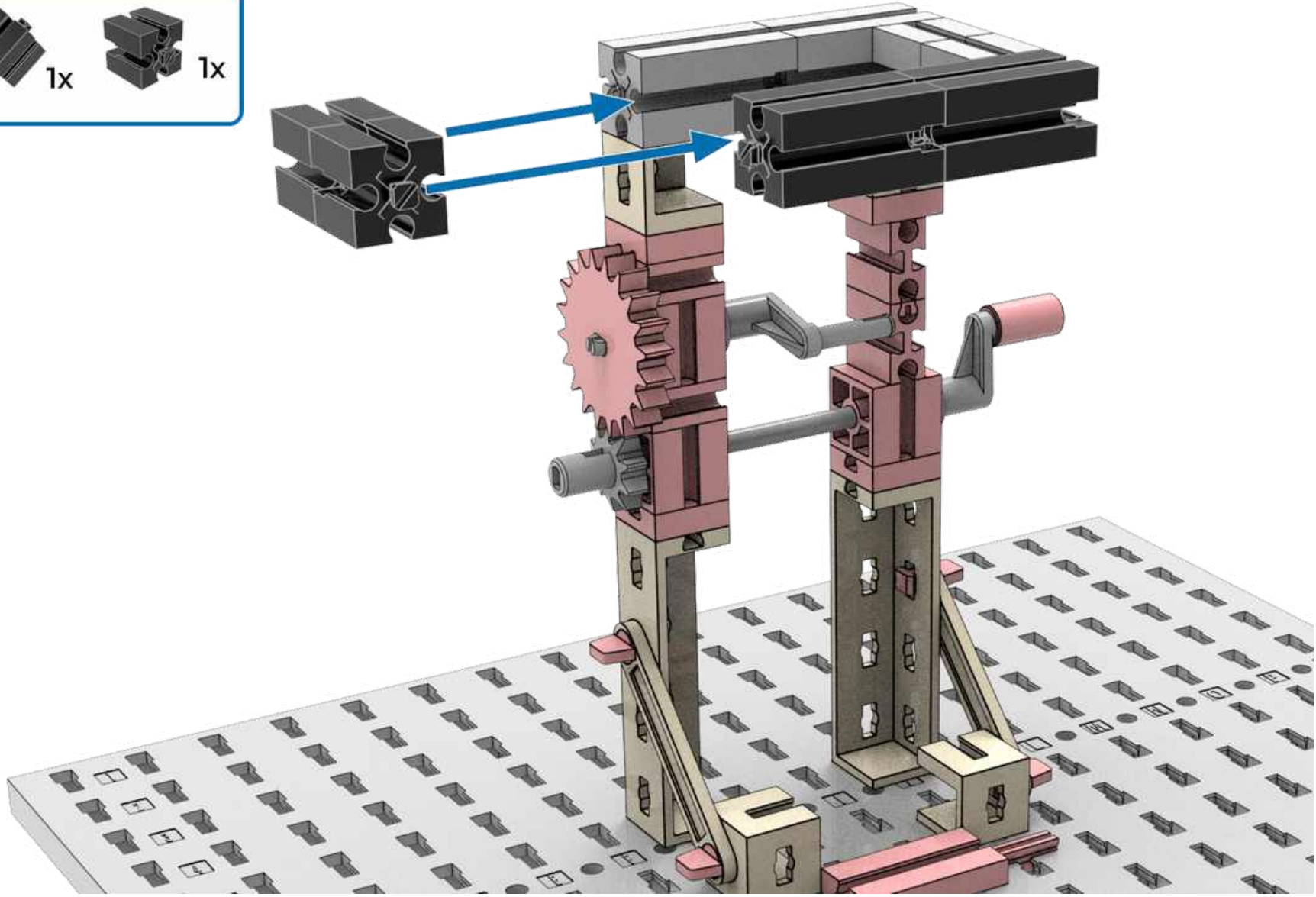



8  2x  1x  1x



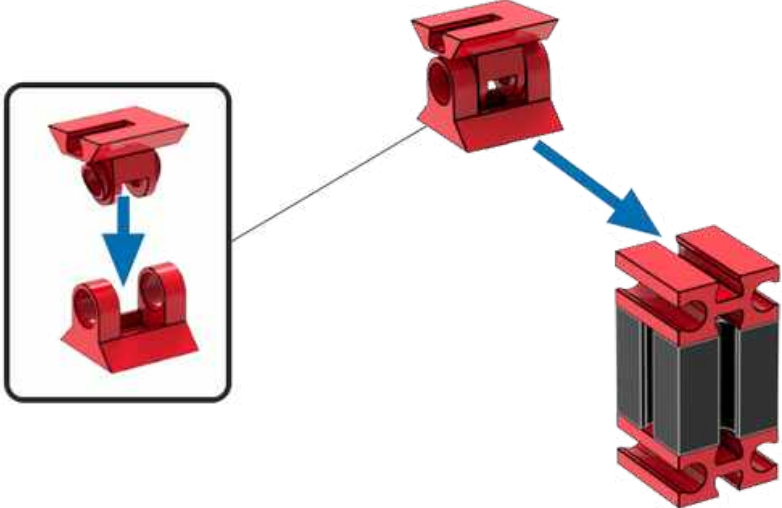



9  1x  2x  1x  1x

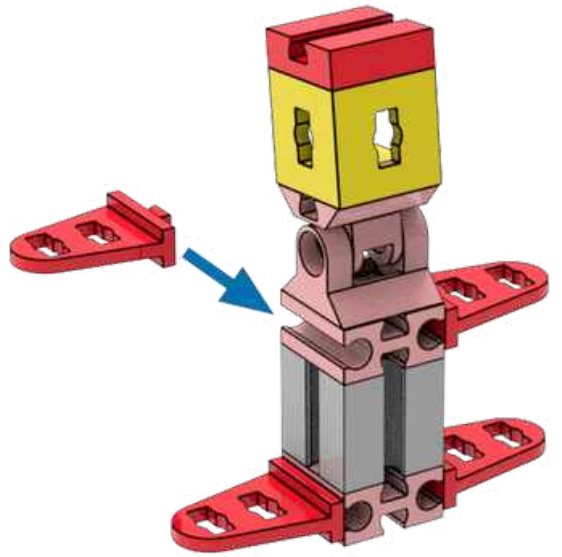

10  1x  1x  4x



11  1x  1x  2x  2x

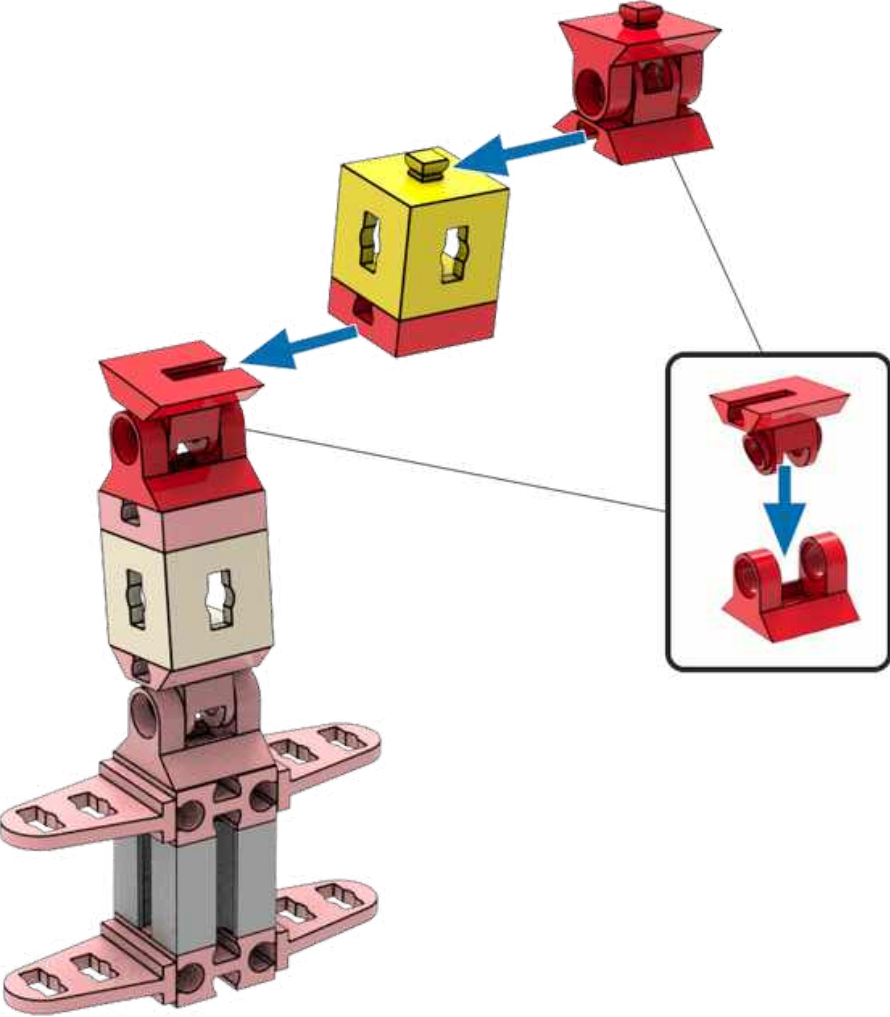

12  2x

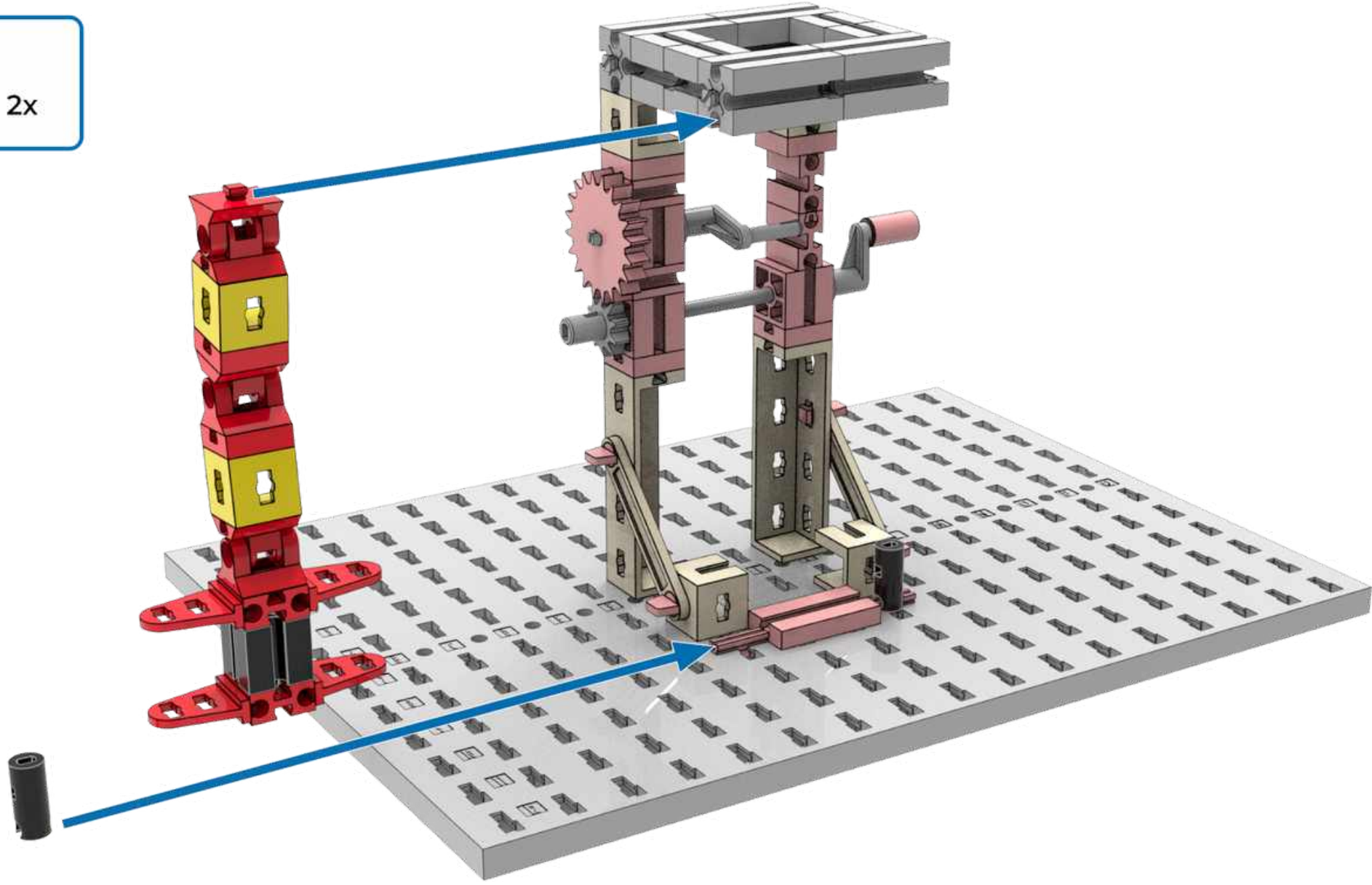

13 30 1x 30 1x  2x

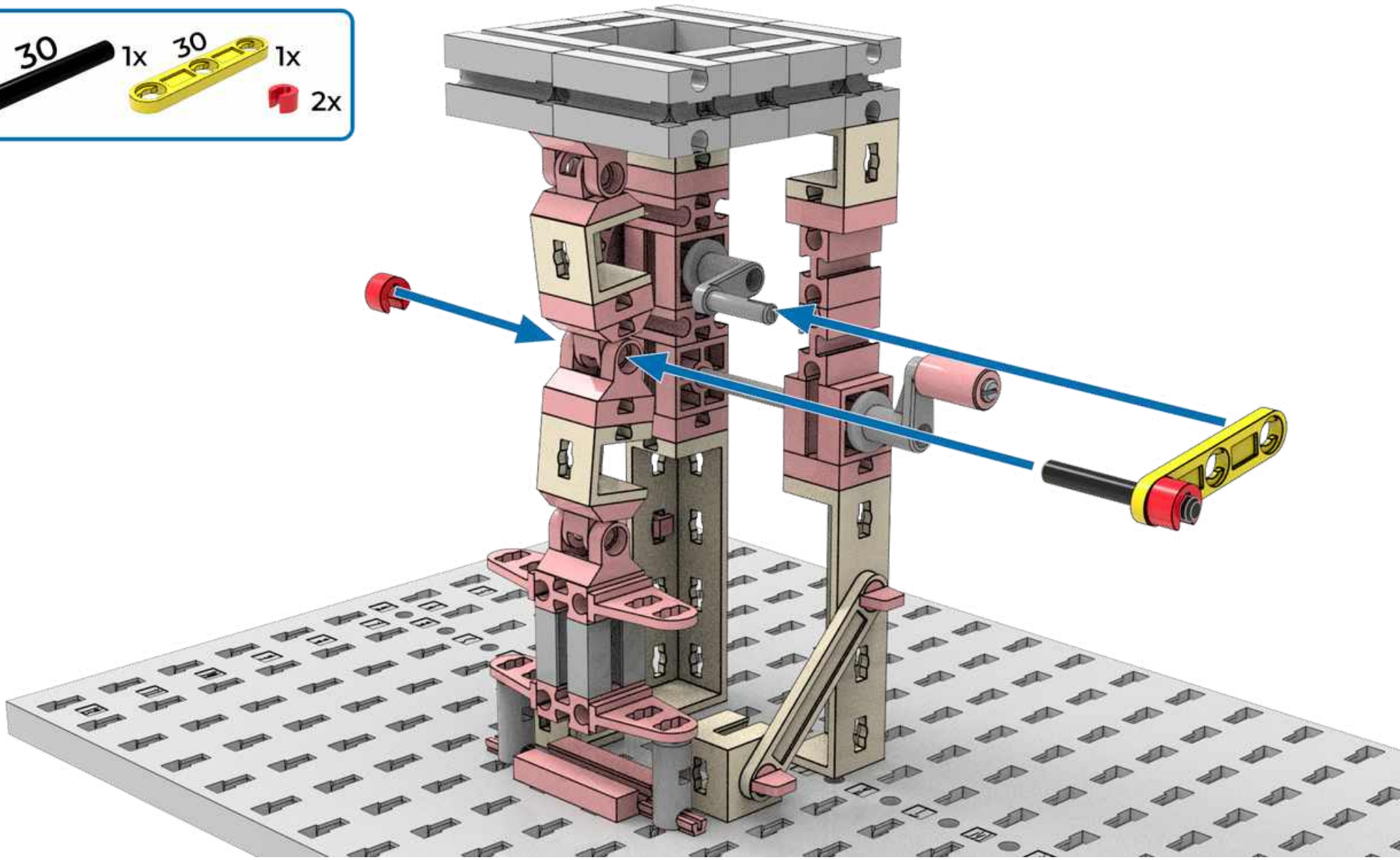

14 90 2x
2x 2x 2x 2x

